

**HIKVISION**



**HD-TVI Speed Dome  
User Manual**

**UD03862B**

## **User Manual**

©2016 Hangzhou Hikvision Digital Technology Co., Ltd.

This user manual is intended for users of HD-TVI Speed Dome. It includes instructions on how to use the Product. The software embodied in the Product is governed by the user license agreement covering that Product.

### **About this Manual**

This Manual is subject to domestic and international copyright protection. Hangzhou Hikvision Digital Technology Co., Ltd. (“Hikvision”) reserves all rights to this manual. This manual cannot be reproduced, changed, translated, or distributed, partially or wholly, by any means, without the prior written permission of Hikvision.

### **Trademarks**

**HIKVISION** and other Hikvision marks are the property of Hikvision and are registered trademarks or the subject of applications for the same by Hikvision and/or its affiliates. Other trademarks mentioned in this manual are the properties of their respective owners. No right of license is given to use such trademarks without express permission.

### **Disclaimer**

TO THE MAXIMUM EXTENT PERMITTED BY APPLICABLE LAW, HIKVISION MAKES NO WARRANTIES, EXPRESS OR IMPLIED, INCLUDING WITHOUT LIMITATION THE IMPLIED WARRANTIES OF MERCHANTABILITY AND FITNESS FOR A PARTICULAR PURPOSE, REGARDING THIS MANUAL. HIKVISION DOES NOT WARRANT, GUARANTEE, OR MAKE ANY REPRESENTATIONS REGARDING THE USE OF THE MANUAL, OR THE CORRECTNESS, ACCURACY, OR RELIABILITY OF INFORMATION CONTAINED HEREIN. YOUR USE OF THIS MANUAL AND ANY RELIANCE ON THIS MANUAL SHALL BE WHOLLY AT YOUR OWN RISK AND RESPONSIBILITY.

TO THE MAXIMUM EXTENT PERMITTED BY APPLICABLE LAW, IN NO EVENT WILL HIKVISION, ITS DIRECTORS, OFFICERS, EMPLOYEES, OR AGENTS BE LIABLE TO YOU FOR ANY SPECIAL, CONSEQUENTIAL, INCIDENTAL, OR INDIRECT DAMAGES, INCLUDING, AMONG OTHERS, DAMAGES FOR LOSS OF BUSINESS PROFITS, BUSINESS INTERRUPTION, SECURITY BREACHES, OR LOSS OF DATA OR DOCUMENTATION, IN CONNECTION WITH THE USE OF OR RELIANCE ON THIS MANUAL, EVEN IF HIKVISION HAS BEEN ADVISED OF THE POSSIBILITY OF SUCH DAMAGES.

SOME JURISDICTIONS DO NOT ALLOW THE EXCLUSION OR LIMITATION OF LIABILITY OR CERTAIN DAMAGES, SO SOME OR ALL OF THE ABOVE EXCLUSIONS OR LIMITATIONS MAY NOT APPLY TO YOU.

### **Support**

Should you have any questions, please do not hesitate to contact your local dealer.

Thank you for purchasing our product. If there are any questions, or requests, please do not hesitate to contact the dealer.

## Regulatory Information

### FCC Information

Please take attention that changes or modification not expressly approved by the party responsible for compliance could void the user's authority to operate the equipment.

**FCC compliance:** This equipment has been tested and found to comply with the limits for a Class A digital device, pursuant to part 15 of the FCC Rules. These limits are designed to provide reasonable protection against harmful interference when the equipment is operated in a commercial environment. This equipment generates, uses, and can radiate radio frequency energy and, if not installed and used in accordance with the instruction manual, may cause harmful interference to radio communications. Operation of this equipment in a residential area is likely to cause harmful interference in which case the user will be required to correct the interference at his own expense.

#### FCC Conditions

This device complies with part 15 of the FCC Rules. Operation is subject to the following two conditions:

1. This device may not cause harmful interference.
2. This device must accept any interference received, including interference that may cause undesired operation.

### EU Conformity Statement



This product and - if applicable - the supplied accessories too are marked with "CE" and comply therefore with the applicable harmonized European standards listed under the Low Voltage Directive 2014/35/EU, the EMC Directive 2014/30/EU, the RoHS Directive 2011/65/EU.



2012/19/EU (WEEE directive): Products marked with this symbol cannot be disposed of as unsorted municipal waste in the European Union. For proper recycling, return this product to your local supplier upon the purchase of equivalent new equipment, or dispose of it at designated collection points. For more information see: [www.recyclethis.info](http://www.recyclethis.info).



2006/66/EC (battery directive): This product contains a battery that cannot be disposed of as unsorted municipal waste in the European Union. See the product documentation for specific battery information. The battery is marked with this symbol, which may include lettering to indicate cadmium (Cd), lead (Pb), or mercury (Hg). For proper recycling, return the battery to your supplier or to a designated collection point. For more information see: [www.recyclethis.info](http://www.recyclethis.info).



## Safety Instruction

These instructions are intended to ensure that the user can use the product correctly to avoid danger or property loss.

The precaution measure is divided into ‘Warnings’ and ‘Cautions’:

**Warnings:** Serious injury or death may be caused if any of these warnings are neglected.

**Cautions:** Injury or equipment damage may be caused if any of these cautions are neglected.

	
<b>Warnings</b> Follow these safeguards to prevent serious injury or death.	<b>Cautions</b> Follow these precautions to prevent potential injury or material damage.



### Warnings:

- Adopt the power adapter which can meet the safety extra low voltage (SELV) standard. Refer to the specification manual for the standard of power adapter and the power consumption cannot be less than the required value.
- Do not connect several devices to one power adapter as an adapter overload may cause over-heating and can be a fire hazard.
- When the product is installed on a wall or ceiling, the device should be firmly fixed.
- To reduce the risk of fire or electrical shock, do not expose the indoor used product to rain or moisture.
- This installation should be made by a qualified service person and should conform to all the local codes.
- Install blackouts equipment into the power supply circuit for convenient supply interruption.
- If the product does not work properly, please contact your dealer or the nearest service center. Never attempt to disassemble the product yourself. (We shall not assume any responsibility for problems caused by unauthorized repair or maintenance.)

**Cautions:**

- Make sure the power supply voltage is correct before using the product.
- Do not drop the product or subject it to physical shock. Do not install the product on vibratory surface or places.
- Do not expose it to high electromagnetic radiating environment.
- Do not aim the lens at the strong light such as sun or incandescent lamp. The strong light can cause fatal damage to the product.
- The sensor may be burned out by a laser beam, so when any laser equipment is being used, make sure that the surface of the sensor not be exposed to the laser beam.
- Do not place the dome in extremely hot, cold, dusty or damp locations, otherwise fire or electrical shock will occur. Refer to the Specification for the details of operating temperature.
- To avoid heat accumulation, good ventilation is required for a proper operating environment.
- While shipping, the product should be packed in its original packing.
- Use the provided glove when open up the product cover. Do not touch the product cover with fingers directly, because the acidic sweat of the fingers may erode the surface coating of the product cover.
- Use a soft and dry cloth when clean inside and outside surfaces of the product cover. Do not use alkaline detergents.
- Improper use or replacement of the battery may result in hazard of explosion. Please use the manufacturer recommended battery type.

# Table of Contents

<b>Chapter 1 Overview</b> .....	<b>1</b>
1.1 Description.....	1
1.2 Functions.....	1
<b>Chapter 2 Getting Started</b> .....	<b>4</b>
2.1 Power-up Action.....	4
2.2 Basic Operations.....	5
2.3 System-defined Presets.....	5
2.4 On-screen Displays.....	6
<b>Chapter 3 Menu Operation</b> .....	<b>7</b>
3.1 Accessing and Operating the Menu.....	8
3.2 Configuring System Information.....	8
3.2.1 Checking System Information.....	8
3.2.2 Configuring System Parameters.....	9
3.3 Configuring Image Parameters.....	13
3.3.1 Configuring Camera Parameters.....	13
3.3.2 Configuring Privacy Mask.....	19
3.3.3 Configuring Output Standard.....	20
3.3.4 Configuring IR Parameters.....	21
3.4 Configuring PTZ Control Parameters.....	22
3.4.1 Configuring PTZ Parameters.....	22
3.4.2 Configuring Presets.....	24
3.4.3 Configuring Patrols.....	25
3.4.4 Configuring Patterns.....	26
3.4.5 Configuring Timing Tasks.....	28
3.4.6 Configuring Zone.....	30
3.5 Configuring and Handling Alarms.....	32
3.5.1 Configuring Alarm Input and Linkage Actions.....	32
3.5.2 Configuring Alarm Parameters.....	33
3.5.3 Configuring Alarm Output.....	34
3.6 Others.....	35
3.6.1 Restoring Default Dome Settings.....	35
3.6.2 Restoring Default Camera Settings.....	35
3.6.3 Rebooting the Dome.....	35
<b>Appendix</b> .....	<b>35</b>
Appendix 1 Lightning & Surge Protection.....	36
Appendix 2 RS485 Bus Connection.....	37
Appendix 3 24VAC Wire Gauge & Transmission Distance.....	40
Appendix 4 Wire Gauge Standards.....	41

# Chapter 1 Overview

## 1.1 Description

Integrated with the built-in pan/tilt unit, the HD-TVI speed dome features highly sensitive response and reliable performance. The speed dome can be adopted in various surveillance fields with its full-integral functions and features, such as corridor, large venue, meeting room, station, neighborhoods, etc.

## 1.2 Functions



The functions vary according to the different models of the speed dome.

- **Coaxial Control**

The speed dome with a specified DVR or controller can be sent the control signals via coaxial cable (BNC cable).

- **High-Definition Output**

The resolution of the output image can be up to 1080P.

- **Limits**

The dome can be programmed to move within the limits(left/right, up/down).

- **Self-adaptive Protocol**

While using RS485 control, the speed dome is compatible with PELCO-D, PELCO-P and PRIVATE-Code, etc., and is capable of being self-adaptive to these protocols without selecting protocol by DIP switch settings. While using coaxial control, the speed dome is self-adaptive to PELCO-D and PRIVATE-Code protocols.

- **Keyboard Control**

The pan/tilt movement and zoom actions of dome can be controlled by the control keyboard, DVR, matrix, etc.

- **Scan Modes**

The dome provides 5 scan modes: auto scan, tilt scan, and panorama scan.

- **Preset Freezing**

This feature freezes the scene on the monitor when the dome is moving to a preset. This allows for smooth transition from one preset scene to another. It also guarantees that masked area will not be revealed when the dome is moving to a preset.

- **Presets**

A preset is a predefined image position. When the preset is called, the dome will automatically move to the defined position. The presets can be added, modified, deleted and called.

- **Label Display**

The on-screen label of the preset title, PT display, zoom, and time can be displayed on the monitor.

- **Auto Flips**

In manual tracking mode, when a target object goes directly beneath the dome, the video will automatically flip 180 degrees in horizontal direction to maintain continuity of tracking. This function can also be realized by auto mirror image depending on different camera models.

- **Privacy Mask**

This function allows you to block or mask certain area of a scene, for preventing the personal privacy from recording or live viewing. A masked area will move with pan and tilt functions and automatically adjust in size as the lens zooms telephoto and wide.

- **3D Positioning**

In the client software, use the left key of mouse to click on the desired position in the video image and drag a rectangle area in the lower right direction, then the dome system will move the position to the center and allow the rectangle area to zoom in. Use the left key of mouse to drag a rectangle area in the upper left direction to move the position to the center and allow the rectangle area to zoom out.

- **Proportional Pan/Tilt**

Proportional pan/tilt automatically reduces or increases the pan and tilt speeds according to the amount of zoom. At telephoto zoom settings, the pan and tilt speeds will be slower than at wide zoom settings. This keeps the image from moving too fast on the live view image when there is a large amount of zoom.

- **Auto Focus**

The auto focus enables the camera to focus automatically to maintain clear video images.

- **Day/Night Auto Switch**

The speed domes deliver color images during the day. And as light diminishes at night, the speed domes switch to night mode and deliver black and white images with high quality.

- **Slow Shutter**

In slow shutter mode, the shutter speed will automatically slowdown in low illumination conditions to maintain clear video images by extending the exposure time. The feature can be enabled or disabled.

- **Backlight Compensation (BLC)**

If you focus on an object against strong backlight, the object will be too dark to be seen clearly. The BLC (Backlight Compensation) function can compensate light to the object in the front to make it clear, but this causes the over-exposure of the background where the light is strong.

- **Wide Dynamic Range (WDR)**

The wide dynamic range (WDR) function helps the camera provide clear images even under back light circumstances. When there are both very bright and very dark areas simultaneously in the field of view, WDR balances the brightness level of the whole image and provide clear images with details.

- **White Balance (WB)**

White balance can remove the unrealistic color casts. White balance is the white rendition function of the camera to adjust the color temperature according to the environment automatically.

- **Patrol**

A patrol is a memorized series of pre-defined preset function. The scanning speed between two presets and the dwell time at the preset are programmable.

- **Pattern**

A pattern is a memorized series of pan, tilt, zoom, and preset functions. By default the focus and iris



are in auto status during the pattern is being memorized.

- **Power Off Memory**

The dome supports the power off memory capability with the predefined resume time. It allows the dome to resume its previous position after power is restored.

- **Time Task**

A time task is a preconfigured action that can be performed automatically at a specific date and time. The programmable actions include: pan scan, patrol 1-8, pattern 1-4, preset 1-8, panorama scan, tilt scan, day, night, and none.

- **Park Action**

This feature allows the dome to start a predefined action automatically after a period of inactivity.

# Chapter 2 Getting Started

## 2.1 Power-up Action

After the speed dome is power-on, it will perform a series of self-test actions. It runs the pan checking firstly, then the tilt checking and the camera checking at last. After the power-up actions, the system information will be displayed for 120 s on the live view screen as shown below.

```

                XX-XXXXX-XX
SN                XXXXXXXX
ADDRESS           0
COM FORMAT       2400,8,1
PROTOCOL         AUTO MATCH
FIRMWARE         X.XX
HARDWARE         X.XX
BUILD DATE       XX XX XX
TILT SUCCESS
PAN CHECK ERR
SMART VERSION    VX.XX
    
```

Figure 2-1 System Information

Table 2-1 Descriptions of the System Information

System Info	Description
SN	The serial No. of the speed dome, which is unique.
ADDRESS	The default communication address of the speed dome.
COM Format	The communication settings of the speed dome, including baudrate (2400 by default), data bit (8 by default) and stop bit (1 by default)
PROTOCOL	It is for the communication with other devices.
FIRMWARE	The version of the firmware.
HARDWARE	The version of the hardware.
BUILD DATE	The date when the program of the software is compiled.



- You have to configure the address and the baudrate for the speed dome the same as those in the control devices.
- The speed dome is self-adaptive to the PELCO-D, PELCO-P, and PRIVATE-Code protocols.

## 2.2 Basic Operations

You can operate the speed dome by using a control device, including the control keyboard, DVR, DVS, etc. In this manual, accessing the speed dome via the web browser will be taken as the example.

### Panning and tilting:

Click the direction buttons to control the pan and tilt movement of the speed dome.

### Zooming:

Click the **ZOOM+** and **ZOOM-** buttons to control the zooming.

### Focusing:

Click the **FOCUS+** and **FOCUS-** buttons to adjust the focus.

### Iris:

Click the **IRIS+** and **IRIS-** buttons to adjust the iris.

## 2.3 System-defined Presets

### Purpose:

The section lists the system-defined presets with special functions. These presets cannot be edited but can be only called through a control device, e.g. a DVS or web browser. To call the system-defined presets remotely, you can choose the preset number from the list in the PTZ control panel. Please refer to table below for details.

For instance, preset 99 is the “Start auto scan”. If you call the preset 99, the speed dome starts auto scan function.

Table 2-2 System-defined Presets

Preset NO.	Function	Preset NO.	Function
33	Auto-flip	92	Enable limits
34	Return to home position	93	Set manual limits
35	Patrol 1	94	Remote reboot
36	Patrol 2	95	Access main menu
37	Patrol 3	96	Stop scanning
38	Patrol 4	97	Start Random Scanning
39	IR cut filter in	98	Start Frame Scanning
40	IR cut filter out	99	Start auto scanning
41	Pattern 1	100	Start tilt scanning
42	Pattern 2	101	Start panorama scanning
43	Pattern 3	102	Patrol 5
44	Pattern 4	103	Patrol 6
46	Enable fast patrol	104	Patrol 7
90	Enable Wiper	105	Patrol 8

## 2.4 On-screen Displays

The speed dome supports following on-screen displays:

**Zoom Ratio:** Identifies the amount of magnification. The format is ZXXX. XXX is the zoom amount.

**PT Angle:** Displays panning and tilting direction, with the format of NEXXX/TXXX. The NE followed with XXX indicates the degrees in north east direction, while the T followed with XXX indicates the degrees in tilt position.

**Alarm:** When an alarm is triggered, the corresponding information will be displayed.

**Time:** Displayed as Day/Month/Year/Day of Week/Hour/Minute. It supports 24-hour time system.

**Preset Label:** After you call the configured preset, the preset number is displayed if the lens moves to the certain place where you've set a preset for.

**Zone:** Display the zone title.

**Address:** Display the address of the speed dome.

**Error Rate:** Display the error rate of the speed dome.

**Fan and Heat:** Display the heat information of the speed dome.

# Chapter 3 Menu Operation



- The operation interface of the different speed domes may differ. Please refer to the actual operation interface.
- You can click the left and right direction buttons in the PTZ control panel via the web browser of the DVR to enter the next page or return to the previous page of the submenu if more than one page is available.

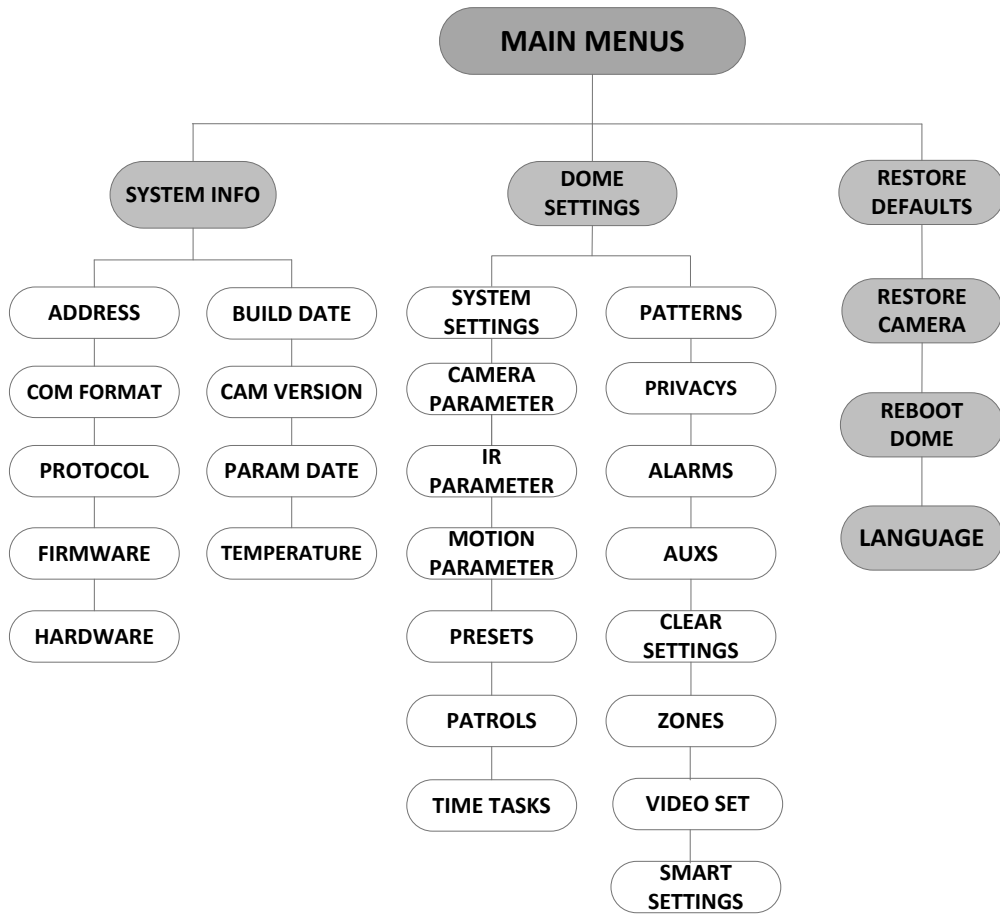

Figure 3-1 Menu Structure

**Before you start:**

You can operate the speed dome by using the on-screen display menu remotely by connecting to a DVR or a DVS (encoder).

**Examples of entering speed dome menu are listed as follows:**

- Enter the menu by pressing buttons: **PTZ -> REC -> 9 -> 5** on the front panel of the DVR.
- Enter the menu by pressing buttons: **CALL -> 9 -> 5 -> ENTER** on the keyboard.
- Enter the menu via the web browser of a DVR/DVS.

Menu operations via the web browser of a DVR will be taken as an example in this chapter.

## 3.1 Accessing and Operating the Menu

**To enter the main menu:**

**Steps:**

1. Connect the video and RS-485 cables of speed dome to a DVR.
2. Visit the DVR via the web browser.
3. View the live video of the speed dome.
4. For PELCO-P/D and other private PTZ protocols, call preset 95 from the preset list in the PTZ control panel of the DVR.

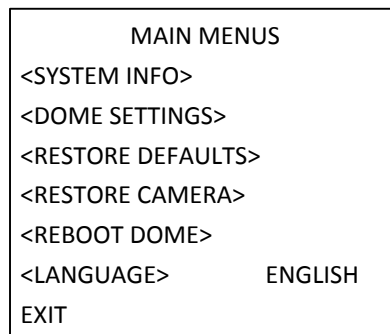

Figure 3-2 Main Menu

**To move the cursor and operate the menu:**

- Move the cursor up/down: On the live view page of the web browser, click up/down direction buttons or **FOCUS +** and **FOCUS -** buttons in the PTZ control panel to move the cursor up and down.
- Enter/Exit: On the live view page of the web browser, click **IRIS+** to enter a submenu; move the cursor to **Exit** and click **IRIS+** to exit.

**To change the value of a parameter:**

**Steps:**

1. Move the cursor to the target item and click **IRIS+** button. You can see the shape of cursor changes.
2. Click the up/down or left/right buttons in the PTZ control panel to choose the value from the selectable value list.
3. Press **IRIS+** to confirm the change or click **IRIS-** to cancel and restore the original value. You can see the shape of cursor changes again.

## 3.2 Configuring System Information

### 3.2.1 Checking System Information

**Purpose:**

System information menu displays the current system information of the speed dome, including

model, address, protocol, etc. The information shown on this submenu is similar to the system information shown after the power-up action. Please refer to *Section 2.1* for more details.

Enter the system information display menu:

**MAIN MENU > SYSTEM INFO**

SYS INFO	XX-XXXXX-X	SYS INFO	
ADDRESS	0	CAM VERSION	X.XX
COM FORMAT	2400,8,1	PARAM DATE	X XX XX
PROTOCOL	SELF ADAPTIVE	TEMPERATURE	38
VERSION	1.00	TRACK	X.XX
HARDVERSION	1.00	TRACKBUILDTIM	161130
BUILD DATE	16 11 04		
BACK	EXIT	BACK	EXIT

Figure 3-3 System Information



- Information on this menu cannot be edited.
- The temperature refers to the internal temperature of the speed dome.

### 3.2.2 Configuring System Parameters

**Purpose:**

You can check and also edit the system information of software address, baud rate, system time, etc. on the system information settings menu.

**MAIN MENU > DOME SETTINGS > SYSTEM INFO SETTINGS**

SYSTEM INFO SETTINGS	SYSTEM INFO SETTINGS	SYSTEM INFO SETTINGS	
SOFT ADDRESS	1	ZERO ANGLE	
SOFT ADDR ACT	OFF	<DISPLAY SETTINGS>	
SOFT BAUD	2400	HEAT CONTROL	TEMP
SOFT BAUD ACT	OFF	FAN CONTROL	TEMP
BROADCAST ADDR	ON	EIS FUNCTION	OFF
PELCO CHECKSUM	ON	EIS LEVEL	N/A
SYSTEM TIME		PRESET FOCUS	OFF
BACK	EXIT	BACK	EXIT
		PROTOCOL STATUS	OFF
		PROTOCOL	AUTO MATCH
		485 CHECK	AUTO
		POWER MEMORY	180S
		COAXITION ACTIVE	ON
		PROTOCOL-C	HIK-C
		BACK	EXIT

Figure 3-4 System Information Settings



You can click the left and right direction buttons in the PTZ control panel via the web browser of the encoder to enter the next page and return to the previous page of the submenu if more than one page is available.

### ◆ Dome address settings

#### To Set the Soft Address of the Speed Dome

If the **SET SOFT ADDR ACT** is set as **ON**, the soft address is the valid address for connecting the speed dome. The selectable soft address ranges from 1 to 255;

If the **SET SOFT ADDR ACT** is set as **OFF**, the hard address set by the DIP switch is the valid address of the speed dome.



- Before you set the soft address of the speed dome, you need to confirm that it is within the control range of the control device (e.g. the DVR).
- After you enable/disable the soft address, the speed dome will reboot automatically to activate the settings.

#### To Set the Broadcast Address of the Speed Dome

When the **BROADCAST ADDR** is set as **ON**, the control device with address 0 is capable of controlling all domes connected to it.

### ◆ Soft Baud Rate Settings

If the **SOFT BAUD** is set as **ON**, the soft baud rate is the valid baud rate for the speed dome, with 2400, 4800, 9600 and 19200 selectable.

If the **SOFT BAUD** is set as **OFF**, the baud rate should be set by the DIP switch.



After you enable/disable the soft baud rate, the speed dome will reboot automatically to activate the settings.

### ◆ PELCO CHECKSUM

The PELCO CHECKSUM is used for Pelco-P and Pelco-D protocols. If the video turns to slack or uncontrollable, you can set the **PELCO CHECKSUM** as **ON** to improve the video quality.

### ◆ System Time Configuration

- (1) Move the cursor to **SYS TIME** using the direction buttons and click **IRIS+** to enter.
- (2) Click the left/right direction buttons to position the cursor on the specific item (year/month/day or hour/minute/second) of which you want to change the value.
- (3) Click the up/down direction buttons to increase/decrease the value.
- (4) Click **IRIS+** button to confirm the settings and exit.



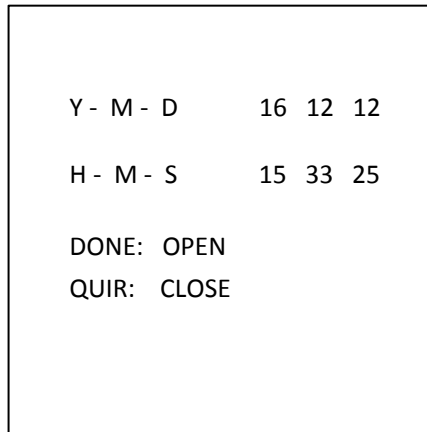

Figure 3-5 Set the System Time

### ◆ Zero Angle Configuration

#### **Purpose:**

You can define the zero angle of the speed dome on the **ZERO ANGLE** submenu.

#### **Steps:**

1. Move the cursor to **ZERO ANGLE** using the direction buttons and click **IRIS+** to enter.
2. Click the left/right/up/down direction buttons to adjust the monitor angle of the speed dome.
3. Click **IRIS+** button to confirm the settings and exit.

### ◆ Display Settings

#### **Purpose:**

You can enable or disable the on-screen display of PTZ movements, alarms, time, preset, zone, address, error rate, and fan/heat show, etc.

#### **Steps:**

1. Move the cursor to **DISPLAY SETTINGS** using the direction buttons and click **IRIS+** to enter.
2. Move the cursor to the target item and click **IRIS+** and click up/down direction buttons to choose each display mode as **ON** or **OFF**, and define each display time as 2 seconds, 5 seconds or 10 seconds.
3. Click **IRIS+** button to confirm the settings.



If you enable the OSD for both **ZOOM SHOW** and **P/T ANGLE**, while calling a preset, the preset No. will be displayed on the screen till the preset scene passes.

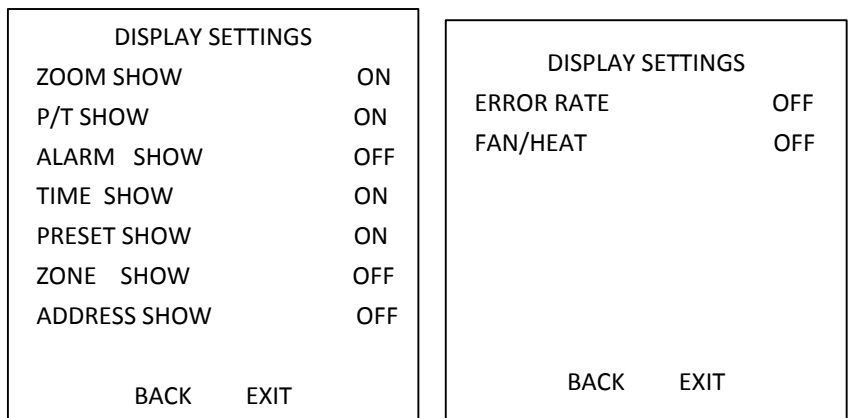

Figure 3-6 Display Settings

The speed dome shows the viewing direction when you manually control it to rotate.

Table 1-1 Viewing Direction Display

Display	N	NE	E	SE	S	SW	W	NW
Indication	North	Northeast	East	Southeast	South	Southwest	West	Northwest



The north direction refers to the angle zero.

● **Heat Parameter Configuration**

You can set the **HEAT CONTROL** as **TEMP** (controlled by the temperature), **ON** or **OFF**.

● **Fan Parameter Configuration**

You can set the **FAN CONTROL** as **TEMP** (controlled by the temperature), **ON** or **OFF**.

● **EIS (Electronic Image Stabilization) Configuration**

You can set the **EIS FUNCTION** as **ON** or **OFF**; and set the **EIS LEVEL** as 0 to 3.



The selectable EIS level varies according to the different camera models.

● **Preset Direct Focus**

You can set the preset direct focus function **ON/OFF** on **PRESET DFOCUS** submenu.

● **Protocol and RS-485 settings**

◆ Select the protocol.

Choose the protocol on **PROTOCOL** submenu. You can configure it as **AUTO MATCH**, **PELCO-P**, **PELCO-D**, or **HIKVISION**. When you choose **AUTO MATCH**, it is protocol self-adaptive.

◆ Set the protocol status.

Set the **PROTOCOL STATUS** as **ON** to enable the user-defined protocol.

- ◆ Enable the RS-485 configuration diagnosis.

You can set **485 CHECK** as **ON** or **AUTO** for automatic RS-485 configuration diagnosis. If the configuration is incorrect, an alert will be received; if you set the value as **AUTO**, it will automatically stop the diagnosis when no errors exist.

● **Power Memory Settings**

The dome can resume its previous PTZ status after it restarted from a power-off when it stops at a position longer than the predefined time. You can set the memory time to 10S, 30S, 60S, 180S, and 300S.

● **Coaxitron Control**

The Coaxial transmission function can be enabled to transmit the RS485 signal along with the video signal via the BNC cable. If the connected encoding device supports the Coaxial transmission as well, the RS485 cable will not be necessary.

Steps:

- 1) Enable the Coaxial control function by setting the option of **COAXITRON ACTIVE** as **ON**.
- 2) Select the Coaxial control protocol, with **HIK-C** is selectable.



The transmission protocol of the connected encoding device should be set the same as the speed dome to support the coaxial transmission.

### 3.3 Configuring Image Parameters

#### 3.3.1 Configuring Camera Parameters

**Purpose:**

You can set the camera parameters including focus, shutter speed, iris, etc.

Enter the camera parameters settings menu:

**MAIN MENU > DOME SETTINGS > CAMERA PARAMETER**

CAMERA		CAMERA	
FOCUS	AF	BLC/WDR	OFF
ZOOM LIMIT	22	BLC LEVEL	N/A
ZOOM SPEED	HIGH	AE MODE	AUTO
SLOW SHUTTER	ON	IRIS	10
IRCUT FILTER	AUTO	SHUTTER	50
D/N LEVEL	1	GAIN	N/A
SHARPNESS	7	EXPOSURE COMP	7
BACK	EXIT	BACK	EXIT

CAMERA		CAMERA		CAMERA	
WHITE BALAN	ATW	WIDE LIMIT	2.0	GAIN LIMIT	15
RED	64	CHROMA SUPPRESS	1	DEFOG	OFF
BLUE	64	SATURATION	1	INIT LENS	OFF
IMAGE FLIP	OFF	CONTRAST	OFF		
FOCUS LIMIT	1M	SCENE MODE	INDOOR		
2D DNR	1	HLC	ON		
3D DNR	2	SHARPNESS COMP	15		
BACK	EXIT	BACK	EXIT	BACK	EXIT

Figure 3-7 Camera Settings

**Task 1:** Configure the focus settings.

- Setting the focus mode

**Steps:**

1. Move the cursor to **FOCUS** using the direction buttons and click **IRIS+** to enter.
2. Click up/down direction buttons to set the focus mode to **AF**, **MF** or **HAF**.

**AF** (Auto-focus): The lens remains in focus during PTZ movements.

**MF** (Manual Focus): You need to adjust the focus with **Focus+** and **Focus-** buttons manually.

**HAF** (Half-auto Focus): The speed dome focuses automatically only once after panning, tilting and zooming.

3. Click **IRIS+** button to save the settings.

- Setting the focus limit

**Purpose:**

This function is used to limit the minimum focus distance. You can configure the focus limit longer when the target is at a distance, to avoid the speed dome focusing on the objects close to it; or configure the focus limit shorter when the target is near the speed dome, and avoid it focuses on the objects father.

You can set **FOCUS LIMIT** to **1CM**, **30 CM**, **1M**, **3M**, **5M**, and **AUTO** to make sure that the speed dome focuses on the target.



The focus limit value varies according to the models of speed dome.

**Task 2:** Configure the zoom settings.

- Setting the zoom limit

**Purpose:**

Zoom limit is a user-defined limitation of the zoom amount (Zoom amount=optical zoom× digital zoom). If you set the zoom limit to the minimum value, the digital zoom will be invalid and the optical zoom will reach the maximum value; if you set the zoom limit smaller, the digital zoom will be enabled.

**Steps:**

1. Move the cursor to **ZOOM LIMIT** using the direction buttons and click **IRIS+** to enter.
2. Click up/down direction buttons to choose the limit from 23, 46, 92, 184, and 368.
3. Click **IRIS+** button to confirm.



If you set the **ZOOM LIMIT** as the minimum value 22, the digital zoom function will be disabled, and the optical zoom function is at its maximum value.

- Configure the zoom speed.

**Purpose:**

You can define the speed at which the lens changes from full wide zoom to the optical zoom.

**Steps:**

1. Move the cursor to **ZOOM SPEED** using the direction buttons and click **IRIS+** to enter.
2. Click up/down direction buttons to choose the speed from **HIGH** (default), **MEDIUM** and **LOW**.
3. Click **IRIS+** button to confirm.

**Task 3:** Configure the IR cut filter.

There are two parameters available for IR cut filter configuration.

1. IR cut filter. It can be set as **AUTO**, **DAY** or **NIGHT**.

**AUTO:** The speed dome is capable of automatically switching from Black and White mode (NIGHT) and Color mode (DAY) regarding to the lightening conditions. It is the default mode.

**NIGHT (B/W):** You can switch the IR cut filter into Black and White mode to increase the lens sensitivity in low light conditions

**DAY (Color):** You can switch it to DAY mode in normal lighting conditions.



- You can call preset 39 to set the IR cut filter mode to **DAY** mode and call preset 40 to set it as **NIGHT** mode.
  - The **IR CUT FILTER** cannot be configured unless the IR light is turned off.
2. D/N LEVEL. The D/N level is the light level for auto D/N mode switch. As a threshold, IR cut filter switches between DAY and NIGHT when the light condition reaches the user-defined D/N level.



D/N level option varies according to the different camera models. Some models do not support user-defined D/N level

**Task 4:** Configure the sharpness level.

The sharpness function can increase the gain of the image and sharpen the edges in the picture to enhance the picture details. You can set the **SHARPNESS** level from 0 to 15.

**Task 5:** Configure the BLC and WDR.



**BLC/WDR** and **BLC LEVEL** varies according to the different camera models. Some models don't support user-defined BLC level.

- (1) **BLC/WDR.** You can set the value as **ON** or **OFF** to enable or disable the functions.

(2) **BLC LEVEL.** You can manually adjust the backlight compensation level.

**Task 6:** Configuring the iris, gain and shutter speed

● **Set the Exposure Mode**

**Purpose:**

AE mode defines the priority of iris, shutter and gain while the speed dome adjusting the brightness of the live view. You can change the mode on **AE MODE** submenu.

**AUTO:** Auto iris, auto shutter and auto gain. The speed dome adjusts the values automatically responding to the lighting conditions. It is the default mode.

**IRIS:** User-defined iris value, auto shutter and auto gain. It is the iris-priority mode. Please define the iris value according to related content in this section if you choose **IRIS** mode.

**SHUTTER:** User-defined shutter speed, auto iris and auto gain. It is the shutter-priority mode. Please define the shutter speed according to related content in this section if you choose **SHUTTER** mode.

**MANUAL:** User-defined iris, gain and shutter. Please define the iris value, gain value and shutter speed according to related content in this section if you choose **MANUAL** mode.

● **Set the Iris Value**

The **IRIS** value measures the amount of light entering to the lens. You can set the iris value from 0 to 17 in response to the changing light conditions.



Iris is fully closed at the value 0 and fully open at the value 17.

● **Set the Gain**

1. Gain value. The value of gain indicates the amplification degree of the original image signal. You can set the value from 0 to 15.

2. Gain limit. The higher gain value you set, the more noises will appear in the image. You can set the maximum user configurable gain value from 0 to 15 to limit the gain range and control the noises in the image.



You need to change the **IR CUT FILTER** as **DAY** or **NIGHT** mode, and set the **AE MODE** as **MANUAL** before you adjust the gain value.

● **Set the Shutter**

**Purpose:**

The speed of the electronic shutter controls the amount of light entering to the lens in a unit of time (a second). You can manually configure the shutter speed for the speed dome, and you can also enable the slow shutter function for low lighting circumstances.

(1) Shutter speed. The larger you set the **SHUTTER** value (the faster the shutter speed is), the fewer the amount of entering light per second is, and the darker the image is. You can set the value as 1, 2, 4, 8, 15, 30, 50, 125, 180, 250, 500, 1000, 2000, 4000 or 10000.



The value of X indicates that the shutter speed is  $1/X$  second. If you set the **SHUTTER** value bigger (shutter speed is faster), the amount of entering light per second is fewer, and the image is darker.

- (2) Slow shutter. Set **SLOW SHUTTER** as **ON**, the shutter speed can automatically slow down to extend exposure time under low lighting circumstances to obtain clearer image.

**Task 7:** Configure exposure compensation.

You can set the **EXPOSURE COMP** value from 0 to 14. The default value is 7. You can adjust this value to increase the brightness of the image.

**Task 8:** Configure white balance.

You can set **WHITE BALAN** as **HAUTO**, **AUTO**, **INDOOR**, **OUTDOOR**, **SELFDEF** (self-defined), **ATW** (auto-tracking) and **HAUTO** (half-auto).

**AUTO:**

In Auto mode, the dome retains color balance automatically according to the current color temperature.

**INDOOR, OUTDOOR:**

These two modes are for indoor use and outdoor use respectively.

**SELFDEF:**

In this mode, you can adjust the color temperature manually to meet your own demand.



In **SELFDEF** mode, you need to adjust the **RED** and **BLUE** values manually.

**ATW:**

In auto-tracking mode, white balance is continuously being adjusted in real-time according to the color temperature of the scene illumination.

**HAUTO:**

Selecting this mode, the viewed image retains color balance automatically according to the current color temperature.

**Task 9:** Configure the image flip.

If you turn the **IMAGE FLIP** function on, the image will be flipped diagonally along its central axis, shown as the mirror reflection of the image.

**Task 10** Configure focus limit

AUTO, 1 CM, 1 M, 3 M, 5 M and 20 M are selectable in **FOCUS LIMIT**. When set it as the AUTO, the focus limit automatically adjusted according to the zoom limit.

**Task 11:** Configure the noise reduction.

To reduce the image noise, you can set the value of **2D DNR** and **3D DNR** respectively. The greater the value is, the less the noise will be in the low illumination environment. You can also disable the function by turning the value as OFF.

**Task 12:** Configure the image quality.

- **Wide Limit**

Set the value of **WIDE LIMIT** to limit the minimum zoom of the lens with 1.0, 1.1, 1.2, 1.3, 1.5, 1.8 and 2.0 available.



The Wide Limit function is supported by certain speed dome model series.

- **Chroma Suppress**

Set the Chroma suppress value from 1 to 3 to suppress the color noise so as to get the clear and high-quality image in the low luminance environment.



The **Chroma Suppress** function is supported by certain speed dome model series.

- **Saturation**

Saturation value from 0 to 7 indicates the brightness of the color. The higher the saturation, the brighter the color is.



The saturation function is supported by certain speed dome model series.

- **Scene Mode**

Select the scene mode as **INDOOR** or **OUTDOOR**, and the default image settings will be changed according to the selected scene mode.

- **Contrast**

Contrast is the degree of difference between the darker and lighter parts of the image.



The contrast function is supported by certain camera model series.

- **HLC**

Set the value of **HLC** to brighten the darker area and weaken the highlight area of the image. The greater the value, the stronger the effect will be.



The HLC function is supported by certain camera model series.

- **Sharpness Compensation**

Set the value from 0 to 15 of **SHARPNESS COMP** to automatically adjust the sharpness of the image to get a clear image. The greater the value is, the stronger the effect will be.

**Task 13:** Configure the defog parameters.



When there is fog in the image, you can enable this function to get clear image.

**Task 14:** Configure the lens initialization.

You can turn INIT LENS on to trigger a spontaneous lens initiation to ensure the normal operation.

### 3.3.2 Configuring Privacy Mask

**Purpose:**

Focus limit enables you to cover certain areas on the live video from being live viewed and recorded. The masked areas can move with the panning/tilting movements and automatically adjust the size as the lens zooming in/out.

**Steps:**

1. Move the cursor to enter the privacy mask configuration submenu:

**MAIN MENUS > DOME SETTINGS > PRIVACYS**

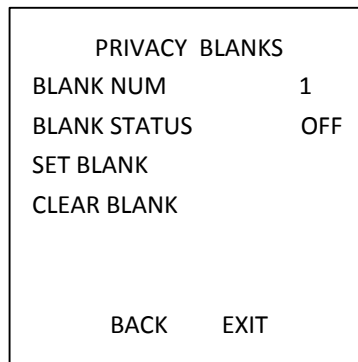

Figure 3-8 Privacy Blank Configuration Menu

2. Choose the privacy blank number:

**Steps:**

- (1) Move the cursor to **BLANK NUM.** and click **IRIS+** to enter the editing mode.
- (2) Click the up and down direction buttons to select a mask number for configuration.
- (3) Click **IRIS+** again to confirm and exit the editing mode.



The configurable privacy blank number varies according to the camera models.

3. Configure the position and size of the privacy blank.

**Steps:**

- (1) Move the cursor to **SET BLANK** and click **IRIS+** button to enter the editing mode as shown in the following figure. You can see the privacy blank on the live window.

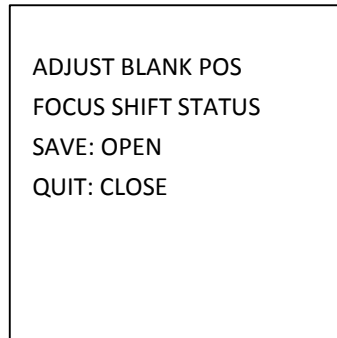

Figure 3-9 Set the Privacy Mask

- (2) You can see *ADJUST BLANK POS* message on the screen. Click the direction buttons to adjust the position of the privacy blank to the designed scene.
- (3) Click **FOCUS+** button, and you can see *ADJUST BLANK SIZE* message on the screen. Click the up/down buttons to increase/decrease the height of the mask and click right/left buttons to increase/decrease the width of the mask. Click **IRIS+** button to save the settings and return to the previous menu and you can see the mask turn to gray.
- (4) To modify the configured mask, click **IRIS+** button to enter the **SET BLANK** menu and click **IRIS+** button again to edit.



focus limit

The tilt range for configuring the privacy blanks is from  $-15^{\circ}$  to  $60^{\circ}$ .

4. Enable or disable the privacy blank function.

Move the cursor to **BLANK STATUS**. Click **IRIS+** button to enter the editing mode and click the up and down direction buttons to set it **ON** or **OFF**.



If no privacy blank has been configured, you cannot set the status as **ON**.

5. Delete the privacy blank.

You can enter the **CLEAR BLANK** menu to delete the all the configured privacy blanks.

### 3.3.3 Configuring Output Standard

#### **Purpose:**

The video output standard, including resolution and frame rate, can be changed according to the actual requirement.

#### **Steps:**

1. Move the cursor to enter the Video Settings submenu:  
**MAIN MENU > DOME SETTINGS > VIDEO SET**
2. Move the cursor to **VIDEO STD** and click **IRIS+** to enter the editing mode.
3. Click the up and down direction buttons to select a desired video standard.
4. Click **IRIS+** again to confirm and exit the editing mode.

### 3.3.4 Configuring IR Parameters



The IR parameter settings are supported by IR speed domes only.

**Purpose:**

You can configure the IR parameters including the IR sensitivity, n/m LED current, far LED current, reference zoom, and LED control, fan control, switch delay, smart IR, etc..

Enter the LED parameter submenu:

**MAIN MENU > DOME SETTINGS > IR PARAMETER**

IR PARAMETER	
IR SENSITIVITY	MEDIUM
N/M LED CURRENT	8
FAR LED CURRENT	8
REFERENCE ZOOM	2
LED CONTROL	ICR
SWITCH DELAY(S)	2
SMART IR	0
BACK    EXIT	

Figure 3-10 IR Settings

- Set the sensitivity of the IR LED.  
You can set the **SENSITIVITY** as **HIGH**, **MEDIUM**, or **LOW**.
- Set the electricity level of the IR LED.  
The **N/M LED CURRENT** and the **FAR LED CURRENT** refer to the electricity level of the near/middle IR LED and far IR LED correspondingly. You can set the near/far LED current and the far LED current to **1 to 10**.
- Set the parameters for reference zoom.  
The value of **REFERENCE ZOOM** can be adjusted from 2 to 10.
- Set the parameters of LED control.  
LED control can be set to **ALL ON** (enable all the IR LED), **FAR ON** (enable far-distance IR LED), **NEAR ON** (enable near/medium-distance IR LED), **AUTO** (enable IR LED automatically according to the environment illumination), **ICR** (adjust the IR LED working mode according to the ICR), and **CLOSE** (disable IR LED).
- Set the IR LED switch delay.  
The **SWITCH DELAY(S)** refers to the delay time between the switch of far-distance IR LED and N/M-distance IR LED.
- Set smart IR.  
The brightness of IR automatically changes according to the focal length. The greater the value, the more obvious the brightness changed.

### 3.4 Configuring PTZ Control Parameters

**Purpose:**

You can configure panning, tilting and zooming movements, and configure PTZ control functions including presets, patrols, patterns, etc. for the speed dome.

#### 3.4.1 Configuring PTZ Parameters

Enter PTZ configuration menu:

**MAIN MENU > DOME SETTINGS > MOTION PARAMETER**

MOTION		MOTION	
AUTO FLIP	ON	PRESET SPEED	4
PROPORTIONAL PAN	ON	LIMIT STOP	OFF
PARK TIME	5	SETTING STOPS	
PARK ACT	NONE	CLEAR STOPS	
SCAN SPEED	28	ELEVATION SET	ON
IMAGE FREEZE	OFF		
DOMES SPEED	6		
BACK	EXIT	BACK	EXIT

Figure 3-11 PTZ Configuration

- **Auto-flip**

In manual tracking mode, when a target object goes directly beneath the speed dome, the speed dome automatically rotates 180 degrees horizontally for tracking.



**AUTO-FLIP** is set as **ON** for this speed dome by default and it's not user-definable.

- **Proportional Pan**

When the speed dome is zooming in/out, you can enable the proportional pan function to automatically reduce or increase the panning and tilting speed according to the zooming amount. This function enables the speed dome to trace the object at a proper speed when the speed dome is zooming and the monitored scene is narrowed (zoom in) or enlarged (zoom out).

You can set **PROPORTIONAL PAN** as **ON** or **OFF** to enable/disable the function.



This function is enabled automatically while setting the patterns.

- **Park time and actions**

**Purpose:**

This feature allows the speed dome to start a predefined action (park action: scan, preset, pattern, etc.) automatically after a period of inactivity (park time).

You can set **PARK TIME** from 5 to 720 seconds and set the park action (**PARK ACT**) as preset 1 to 8, pattern 1 to 5, patrol 1 to 10, pan scan, tilt scan, panoramic scan, day mode, night mode, or none.



If no control signal is received after the park time under the following circumstances, no park actions will be performed: in the process of performing dome actions by calling special presets; or in the process of performing external alarm linkage actions.

### ● Image freeze

This feature enables the live view to switch directly from the current scene to another scene that is defined by a preset, without showing the middle areas between these two scenes. It reduces the use of bandwidth in a digital network system and it also provides privacy protection for the middle areas.

You can set **IMAGE FREEZE** as **ON** or **OFF** to enable or disable this function.



The function varies according to the different camera models.

### ● PTZ speed

#### **Purpose:**

You can define the speed of the dome movements.

- (1) **DOME SPEED:** The manual movement speed of the dome can be set from level 1 to 10.
- (2) **SCAN SPEED:** The scan speed defines the scan degree per second of pan scan, tilt scan, and panoramic scan. The scan speed is adjustable from level 1 to level 40 and the higher the level is, the faster the scan speed is.
- (3) **PRESET SPEED:** The speed of calling a preset can be set from level 1 to 8. The higher level corresponds to the faster speed to call a preset.

### ● Setting Limits

#### **Purpose:**

The limits are user-configurable positions which limit the panning and tilting area of the speed dome. There are left, right, up and down limits to define an area.

#### **Steps:**

1. Move the cursor to **ENABLE LIMIT** and click **FOCUS+** to set it **ON** to enable this feature. Click **IRIS+** to confirm the new settings.
2. Move the cursor to **SETTING STOPS** and click **IRIS+**. You will see the message *SET LEFT LIMIT* on the screen.
3. Click the direction buttons in the PTZ panel to configure the left limit. Click **IRIS+** to confirm the new settings.
4. Follow the prompts to configure the right, up and down limits on the menu.



The new limit will overwrite the existed ones by default.

5. You can clear the defined limits. Click **IRIS+** to enter **CLEAR LIMITS** and click **IRIS+** again to clear the stops.

### ● Elevation set

You can set the **SET ELEVATION** as **ON** to increase the elevation angle range of the speed dome or set it as **OFF** to disable the function.



The range of the elevation angle varies from different speed dome models.

## 3.4.2 Configuring Presets

### **Purpose:**

A preset is a user-defined monitoring position/point. You can simply call the preset number to change the monitor scene to the defined position.

### **Steps:**

1. Move the cursor to enter preset configuration submenu:

**MAIN MENU > DOME SETTINGS > PRESETS**

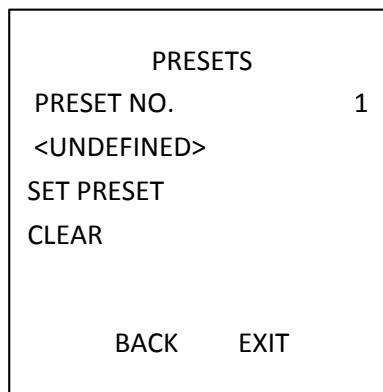

Figure 3-12 Preset Configuration Menu

2. Choose the preset number:

Move the cursor to **PRESET NUM.** and click **IRIS+** to enter. Click the up and down buttons to choose the preset number which needs to be edited. If the preset has been defined, the preset label will be listed under the number; if it has not been defined, you will see the information **UNDEFINED** under the number.



- There are up to 256 presets can be set for the speed dome.
  - The system-defined presets will be displayed on this submenu and they are not editable.
3. Set the preset position.  
Move the cursor to **PRESET PTZ** and click **IRIS+** to edit the preset position. Use the direction buttons to move the speed dome to find the desired scene/position, and then press **IRIS+** to confirm the settings and return to the previous menu, or press **IRIS-** to cancel.



The preset position settings will be restricted by the limits if they are defined.

4. Call the presets.

You can select the preset number from the drop-down preset list in the control panel of the encoder through a web browser, and click the arrow to call a user-defined or system-defined preset.

5. Clear the preset settings.

Move the cursor to **CLEAR** and click **IRIS+** to clear the settings of the current preset.

### 3.4.3 Configuring Patrols

**Purpose:**

A patrol is a scanning track specified by a group of user-defined presets. You can call a patrol to scan the scenes automatically among the user-defined presets in sequence.

**Steps:**

1. Move the cursor to enter patrol configuration submenu:

**MAIN MENU > DOME SETTINGS > PATROLS**

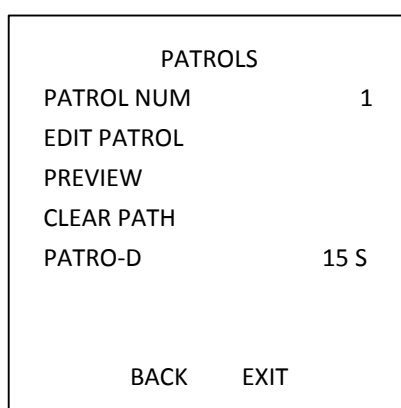

Figure 3-13 Patrol Configuration Menu

2. Choose the patrol number.

**Steps:**

- (1) Move the cursor to **PATROL NUM** and click **IRIS+** to enter editing mode.
- (2) Click the up and down direction buttons to select the number of the patrol which is to be configured.
- (3) Click **IRIS+** again to confirm the settings and exit editing mode of this column.



Up to 10 patrols can be configured.

3. Edit the patrol.

**Steps:**

- (1) Move the cursor to **EDIT PATROL** and click **IRIS+** to enter editing mode.

NUM	PST	DWELL	SPD
1	0	6	30
2	0	6	30
3	0	6	30
4	0	6	30
5	0	6	30
6	0	6	30
7	0	6	30
DONE: OPEN		QUIT: CLOSE	

Figure 3-14 Edit the Patrol

- (2) Click up/down direction buttons to choose the number and locate the preset to be edited.
- (3) Click left/right direction buttons to position the cursor to the column of **PRESET**, **DWELL** and **SPEED**. You can click the up/down direction buttons to set the value of preset number, dwell time and patrol speed.



The presets you set for a patrol should be the ones that have been pre-defined by users. The dwell time (15 to 800 seconds selectable, which are divided into 30 levels) is the time that the speed dome stays on a certain preset; the patrol speed (level 1 to 40 selectable) is the scanning speed the speed dome switching between the presets.

- (4) Follow the above steps to define the other presets for the selected patrol. You can configure up to 32 presets in sequence for a patrol. Press **IRIS+** to save the new settings or press **IRIS-** to cancel and return to the previous menu.
4. Preview the patrol.  
Move the cursor to **PREVIEW** and click **IRIS+** to preview the current patrol. You can click **IRIS+** again to stop the preview.
5. Call the defined patrol.  
You can call the special presets to call the defined patrol. E.g. call preset 35 to call patrol 1. Please refer to *Section 2.3* to find the corresponding preset number for each patrol.
6. Delete a patrol.  
You can move the cursor to **CLEAR PATH** and click **IRIS+** to delete the current patrol.
7. Define the dwell time when running the fast patrol.  
If you call the No.46 preset to enable the fast patrol, the speed dome will run the patrol automatically according to the route consists of the configured preset 1 to preset 32. And you can set the Patrol-D time switches from one preset to the other. 5 s, 10 s, 20 s, 30 s, and 60 s are selectable.

### 3.4.4 Configuring Patterns

#### **Purpose:**

A pattern is a memorized, repeatable series of pan, tilt, zoom and preset movements that can be recalled by a command or automatically performed by a configured function (alarm, park, time task,



and power-up).

**Steps:**

1. Move the cursor to enter the **PATTERNS** submenu:

**MAIN MENU > DOME SETTINGS > PATTERNS**

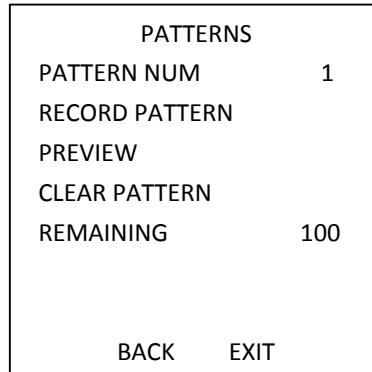

Figure 3-15 Pattern Configuration Menu

2. Choose the pattern number.

- (1) Move the cursor to **PATTERN NUM** and click **IRIS+** to enter the editing mode.

- (2) Click the up/down direction buttons to select the number of the pattern which is to be configured.

- (3) Click **IRIS+** again to confirm the settings.



Up to 5 patterns can be configured.

3. Edit the pattern.

- (1) Move the cursor to **RECORD PATTERN** and click **IRIS+** to enter editing mode.

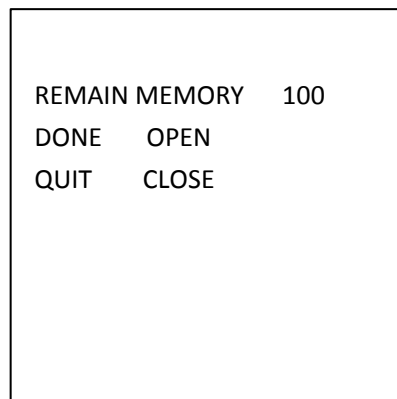

Figure 3-16 Edit the Pattern

- (2) Click the PTZ control buttons and direction buttons to operate the speed dome to draw a movement path, including pan scan, tilt scan, zoom in, zoom out, etc. The speed dome can automatically memorize the path you operated as a pattern.

- (3) Click **IRIS+** again to save the pattern and exit editing mode.



- **REMAIN MEMORY** indicates the remaining memory of the speed dome for configuring the patterns. When it reaches 0, no more patterns can be configured. You can also see the

remaining memory shown under **PATTERNS** menu as *REMAINING*.

- The pan/tilt movements and the lens operations cannot be memorized simultaneously.

4. Preview the pattern.

Enter the **PREVIEW** menu to preview the current pattern.

5. Call the defined pattern.

You can call the special presets to call the defined pattern. E.g. call preset 41 to call pattern 1. Please refer to *Section 2.2* to find the corresponding preset number for each pattern.

6. Delete the patterns.

To Delete a Chosen Pattern

Click **IRIS+** to enter **RECORD PATTERN** and you can see *DEL PATH ABOVE*. Click **IRIS+** to delete the pattern.



If you delete the current pattern, the following pattern will also be deleted. E.g., if pattern 2 is deleted, pattern 3 and pattern 4 will be deleted as well.

To Clear All the Patterns

Enter **CLEAR** menu and click **IRIS+** to delete all the defined patterns.

### 3.4.5 Configuring Timing Tasks

**Purpose:**

A timing task is a preconfigured action that can be performed automatically at a specific date and time.

**Steps:**

1. Move the cursor to enter the **TIMING TASK** submenu:

**MAIN MENU > DOME SETTINGS > TIMING TASK**

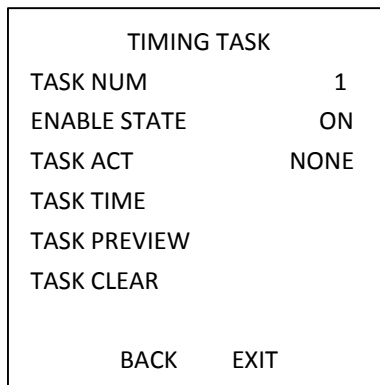

Figure 3-17 Time Task Configuration Menu

2. Choose the task number.

**Steps:**

- (1) Move the cursor to **TASK NUM** and click **IRIS+** to enter the editing mode.
- (2) Click the up/down direction buttons to select the number of the task which is to be configured.
- (3) Click **IRIS+** again to confirm the settings and exit the editing mode.



Up to 8 time tasks can be configured.

3. Set the task status.

**Steps:**

- (1) Move the cursor to **ENABLE TASK** and click **IRIS+** to enter the editing mode.
- (2) Click the up/down direction buttons to set the task status as **ON**.
- (3) Click **IRIS+** again to confirm the settings and exit the editing mode of this column.



If the task action and task time have not been configured, you cannot set the status as **ON**.

4. Configure the task action.

**Steps:**

- (1) Move the cursor to **TASK ACT** and click the **IRIS+** to enter editing mode.
- (2) Click the up and down direction buttons to select the task action from preset 1 to 8, pattern 1 to 5, patrol 1 to 10, pan scan, tilt scan, panoramic scan, day mode, night mode, zero calibrate and none.
- (3) Click **IRIS+** again to confirm the settings and exit editing mode of this column.

5. Set the task time.

**Steps:**

- (1) Move the cursor to **TASK TIME** and click **IRIS+** to enter editing mode.
- (2) Click the left and right direction buttons to position the cursor to **WEEK, START (H-M)** and **END (H-M)**.
- (3) Click the up and down direction buttons to set the start time and end time to run the time task.
- (4) Click **IRIS+** to confirm the settings and exit.



The weekday can be set from **Monday** to **Sunday** or **Whole Week**; the **H** refers to Hour and the **M** refers to Minute.

WEEK	WHOLE WEEK
START (H-M)	00 00
END (H-M)	00 00
DONE: OPEN	
QUIT: CLOSE	

Figure 3-18 Set the Task Time

6. Delete the task.

Move the cursor to **TASK CLEAR**, click **IRIS+** to delete the time and action of the current task, and click **IRIS+** again to confirm the settings and exit.

### 3.4.6 Configuring Zone

**Purpose:**

A zone is a panning and tilting area defined by the left/right limits. You can configure the zones on **ZONES** submenu. You can define a zone when the targeted surveillance scene is limited.

**Steps:**

1. Move the cursor to enter the zone configuration submenu:

**MAIN MENU > DOME SETTINGS > ZONES**

ZONES	
ZONE NUM	1
<UNDEFINED>	
EDIT ZONE	
ZONE STATUS	ON
SCAN STATUS	ON
CLEAR ZONE	
BACK	EXIT

Figure 3-19 Zone Configuration

2. Choose the zone number:
  - (1) Move the cursor to **ZONE NUM**. and click **IRIS+** button to enter the editing mode.
  - (2) Click the up and down buttons to select the zone number to be configured.
  - (3) Click **IRIS+** again to confirm the settings and exit the editing mode of this column.



Up to 8 zones can be configured.

3. Configure the zone area.

**Steps:**

- (1) Move the cursor to **EDIT ZONE** and click **IRIS+** button to enter the editing mode.
  - (2) You can see *SET LEFT LIMIT* on the screen. Click the direction buttons to set the left limit.
  - (3) Follow the prompts on the screen to set the right limit.
  - (4) Click **IRIS+** button to save the settings and exit.
4. Set the zone status and scan status.

**ZONE STATUS:** The zone status just indicates the current status of the zone.

**SCAN STATUS:** You can set the scan status to **ON/OFF** to enable/disable the scanning in the zone.



**ZONE STATUS** is not editable. After you edited the zone, it will switch to **ON** automatically; if you delete the zone, the **ZONE STATUS** will switch to **OFF**.

5. Clear the zone settings.  
Move the cursor to **CLEAR ZONE**, click **IRIS+** to clear all the settings of the current zone, and click **IRIS+** again to confirm the settings and exit.

### 3.4.7 Configuring Smart Settings

**Purpose:**

Set the smart settings as ON to automatically track the moving object, and meanwhile adjusts the focus and the position to set the target in the center of the field of view.

**Steps:**

1. Move the cursor to enter the smart setting submenu:

**MAIN MENU > DOME SETTINGS > SMART SETTINGS**

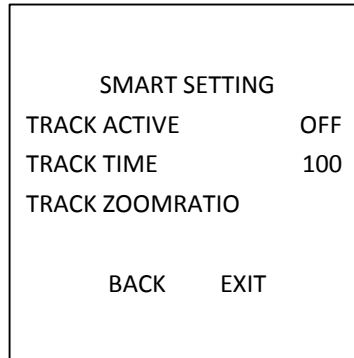

Figure 3-20 Smart Setting

2. Set the tracking time.
  - (1) Move the cursor to **TRACK TIME** and click **IRIS+** button to enter the editing mode.
  - (2) Click the up and down buttons to set the duration for tracking.
  - (3) Click **IRIS+** again to confirm the settings and exit the editing mode of this column.
3. Set the track zoom ratio. Once the zoom ratio is set that the target will be displayed in that ratio on the monitor.
  - (1) Move the cursor to **TRACK ZOOM RATIO** and click **IRIS+** button to enter the editing mode.
  - (2) Click **IRIS+** again to confirm the settings and exit the editing mode of this column.
4. Turn on the tracking.
  - (1) Move the cursor to **TRACK ACTIVE** and click **IRIS+** button to enter the editing mode.
  - (2) Click the up and down buttons to set the **TRACK ACTIVE** as ON.
  - (3) Click **IRIS+** again to confirm the settings and exit the editing mode of this column.



The function varies according to the different camera models.

### 3.4.8 Configuring Clear Settings

**Steps:**

1. Move the cursor to enter the clear settings submenu:

**MAIN MENU > DOME SETTINGS > CLEAR SETTINGS**

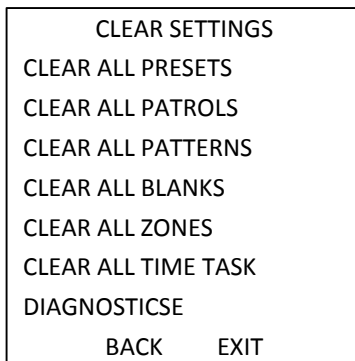

Figure 3-21 CLEAR SETTINGS

2. Move the cursor to the item you want to clear, and click **IRIS+** to validate the settings.
3. Move the cursor to the DIAGNOSTICS and click IRIS+ to diagnose the temperature exception, video exception, voltage exception, etc.



The function varies according to the different camera models.

### 3.5 Configuring and Handling Alarms



The alarm related function is not supported by the 7-inch IR speed dome.

#### 3.5.1 Configuring Alarm Input and Linkage Actions

**Purpose:**

This section states how to configure the speed dome to respond to alarm events with alarm linked actions, such as calling presets, patrols, patterns, scanning, etc..

**Steps:**

1. Move the cursor to enter the alarm configuration submenu:

**MAIN MENUS > DOME SETTINGS > ALARMS**

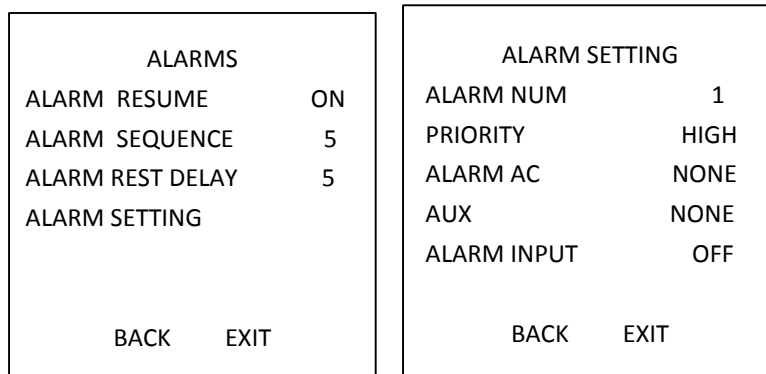

Figure 3-22 Alarm Configuration Menu

- Choose the alarm number.

**Steps:**

- Move the cursor to **ALARM NUM** and click the **IRIS+** to enter the editing mode.
- Click the up and down direction buttons to select the number of the alarm which is to be configured.
- Click **IRIS+** again to confirm and exit editing mode of this column.



You can configure up to 2 alarm inputs.

- Move the cursor to **ALARM SETTING** and click the **IRIS+** to enter the setting alarm submenu.
- Configure the alarm input.

**Steps:**

- Move the cursor to **ALARM INPUT** and click the **IRIS+** to enter the editing mode.
- Click the up and down direction buttons to set the input status. You can configure it as **OPEN** (Normally open), **CLOSE** (Normally closed) or **OFF** (disable the alarm input).
- Click **IRIS+** again to confirm.



If you set the status as **OPEN**, alarm will be triggered by high electricity level; if you set the status as **CLOSE**, alarm will be triggered by low electricity level; if you set the status as **OFF**, it will be triggered when this input channel is shut off.

- Configure the alarm linkage action.

You can specify the linked action when an alarm occurs.

- Move the cursor to **ALARM AC** and click the **IRIS+** to enter the editing mode.
- Click the up and down direction buttons to choose the desired linkage action. You can set the alarm action as preset from 1 to 8, pattern from 1 to 5, patrol from 1 to 10, panning scan, tilting scan, panoramic scan, day mode, night mode or none. You can also set the alarm output for the alarm. Refer to *Section 3.5.3 Configuring Auxiliary Alarm* Output for details.

- Configure alarm priority.

Enter the **PRIORITY** menu and set the alarm priority as **HIGH**, **MIDUEM** or **LOW**.

If multiple alarms with different priorities are triggered at the same time, the dome only responds to the alarm with the highest priority. If multiple alarms with the same priority are triggered at the same time, then the dome will respond to each alarm according to the defined alarm sequence.

## 3.5.2 Configuring Alarm Parameters

**Purpose:**

You can set the alarm related parameters following below instructions, including linkage action interval, alarm duration, and dome activity resumption.

**Steps:**

- Enter the alarm parameter configuration menu:  
**MAIN MENUS > DOME SETTINGS > ALARMS**

2. Configure the interval of the alarm sequence.  
When more than one alarm of the same priority occurs at the same time, the speed dome will respond to one alarm first and then respond to the next one after the user-defined interval. You can set the on **SEQUENCE** submenu from 1 to 200 seconds.
3. Configure the alarm rest delay.  
If there's a linkage action has already been triggered by an alarm input, the speed dome will only respond to the input from the same channel again after the user-defined reset delay time. This is the rest time that the speed dome considers an alarm to be active when it's physically cleared. You can set the **DELAY TIME** from 0 to 300 seconds.
4. Resume the dome activity.  
You can set **ALARM RESUME** as **ON** to enable the speed dome to resume its previous activity after the triggered actions finished.



- If the speed dome is moving when a linkage action is triggered, it will stop at the current position and resume from this position after the linkage action is finished.
- The speed dome can be configured to resume the PTZ positions, focus, and iris value.

### 3.5.3 Configuring Auxiliary Alarm Output

**Purpose:**

An auxiliary alarm output is a configurable alarm output interface on the speed dome back box which can connect and trigger another alarm device to operate.

**Steps:**

1. Enter the alarm output configuration submenu:  
**MAIN MENUS > DOME SETTINGS > AUXS**

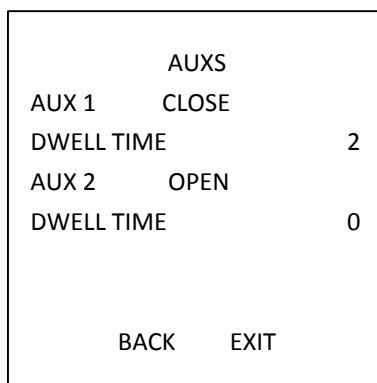

Figure 3-23 Configure the Alarm Output

2. Click **IRIS+** to edit the status of the alarm outputs. You can set the auxiliary alarm output type as **OPEN** (normally open) and **CLOSE** (normally closed).
3. Move the cursor to **DWELL TIME** to set the duration of the alarm output signal. The configurable range is 0 to 60 seconds.
4. Link the alarm output to the configured alarm.

**Steps:**



- (1) Enter **MAIN MENU > DOME SETTINGS > ALARMS > ALARM SETTING** and choose the alarm number that you want to link the alarm output to.
- (2) Move the cursor to **AUXS** and click **IRIS+** to configure the alarm output to the alarm. You can choose **OPEN** to active AUX 1.

## 3.6 Others

### 3.6.1 Restoring Default Dome Settings

**Purpose:**

You can reset all dome settings to factory default parameters as shown in below.



Dome settings are mainly of PTZ parameters and alarm parameters, and also include some system settings, e.g. dome address.

Enter default dome settings menu:

**MAIN MENU > RESTORE DEFAULTS**

Click **IRIS+** to restore the dome settings to the default value, or click **IRIS-** to exit.

### 3.6.2 Restoring Default Camera Settings

Enter **MAIN MENU > RESTORE CAMERA**

Click **IRIS+** to restore the camera settings to the default value; or click **IRIS-** to exit.

### 3.6.3 Rebooting the Dome

Enter **MAIN MENU > REBOOT DOME** and click **IRIS+** to reboot the speed dome.

# Appendix

## Appendix 1 Lightning & Surge Protection

This product adopts TVS plate lightning protection technology to avoid damage caused by pulse signal that is below 3000W, like instantaneous lighting stroke, surging, etc. According to the actual outdoor situation, necessary protection measures must be taken, besides ensuring the electrical safety.

- The distance between signal transmission wires and High-voltage equipment or high-voltage cable is at least 50m.
- Outdoor wiring should better be routed under eaves as much as possible.
- In the open field, wiring should be buried underground in sealed steel pipe, and the steel-pipe should be one-point grounding. Overhead routing method is forbidden.
- In strong thunderstorm area or high induction voltage areas (such as high-voltage transformer substation), high power lightning protection apparatus and lightning conductor are necessary to be added.
- The design of lightning protection and grounding of the outdoor devices and cables should be considered together with the lightning protection demand of buildings. It also must conform to the related national standards and industrial standards.
- The system should be equipotential grounded. The grounding equipment must conform to the demands of system anti-jamming and electrical safety both and it must not appear short circuit or mixed circuit with the zero conductor of strong grid. When the system is grounded alone, the resistance should be no more than  $4\Omega$ . The sectional area of the grounding cable should be no less than  $25\text{mm}^2$ . For grounding instructions, please refer to the Installation Manual of Speed Dome.

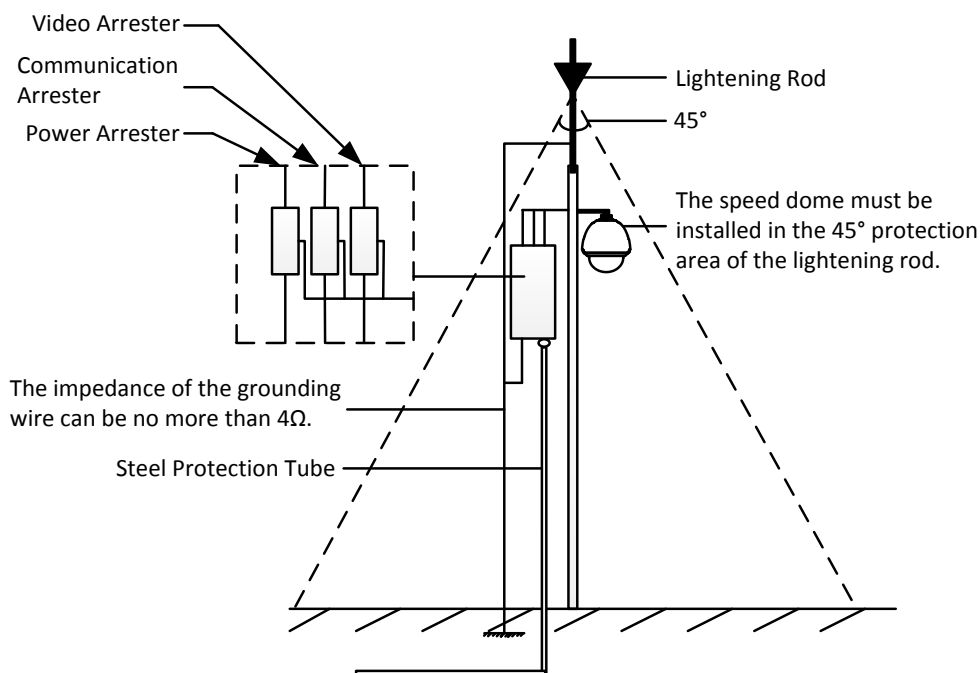

Figure A-1 Lightning & Surge Protection

## Appendix 2 RS485 Bus Connection

- General Property of RS485 Bus

According to RS485 industry bus standard, RS485 is a half-duplex communication bus which has 120Ω characteristic impedance, the maximum load ability is 32 payloads (including controller device and controlled device).

- RS485 Bus Transmission Distance

When using 0.56mm (24AWG) twisted-pair line, according to different baudrate, the maximum transmission distance theory table is shown as below:

Table A-1 Max. Distance of RS485 Transmission

Baudrate	Max Distance
2400BPS	1800m
4800BPS	1200m
9600BPS	800m

The transmission distance will be decreased if we use the thinner cable, or use this product under the strong electromagnetic interference situation, or there are lots of devices are added to the bus; on the contrary, the transmission distance will be increased.

- Connection Methods

RS485 industry bus standard require daisy-chain connection method between any devices, both sides have to connect a 120Ω terminal resistance (show as Diagram 1), the simplified connection method is shown as diagram 2, but the distance of “D” should not be too long.

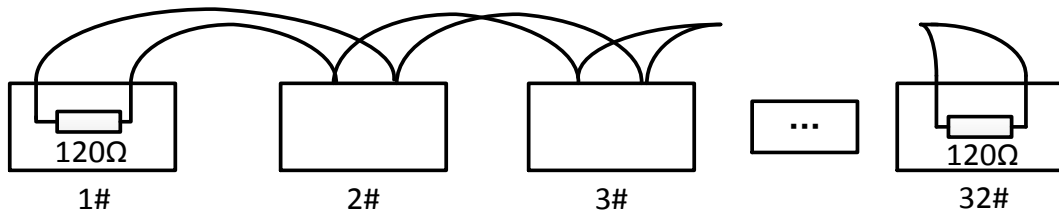

Figure A-2 RS485 Connection 1

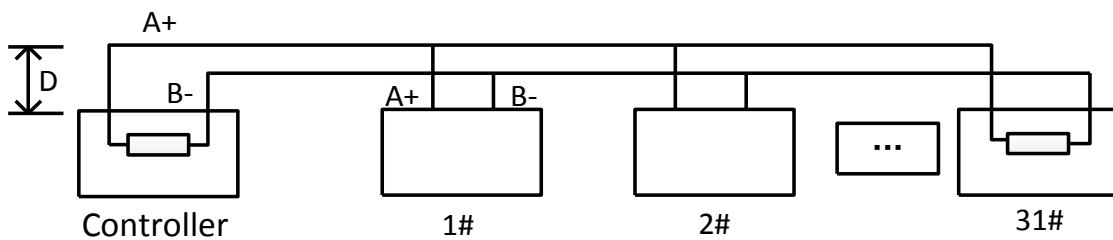

Figure A-3 RS485 Connection 2

- Problems in the Practical Application

Normally, users adopt star-shape connection method in construction, under this situation, the terminal resistors must be connected between two farthest devices (as Figure 4, 1# and 15#), but this connection method is not satisfy the requirement of the RS485 industry standard so that it will lead to some problems such as signal reflection, anti-jamming ability decline when the devices are faraway. At this time, the dome will be uncontrollable, or self-running, etc.

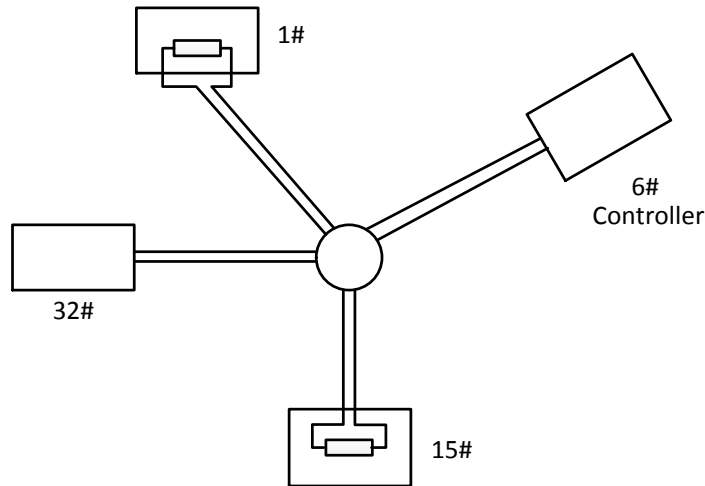

Figure A-4 Star Shape Connection

For such case, the best way is adding a RS485 distributor. This product can effectively change the star-shape connection to which satisfies the requirement of RS485 industry standard, in order to avoid those problems and improve the communication reliability. Show as figure 5.

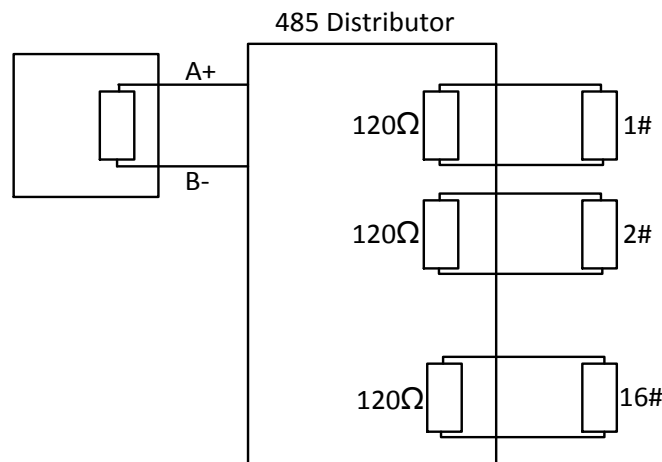

Figure A-5 RS485 Distributor

● Troubleshooting of RS485 communication

Problem	Possible Reasons	To Solve the Problem
The speed dome does the self-test action but cannot be controlled remotely.	1. The address or baudrate of the speed dome does not match with those of remote control device.	1. Adjust the address and baudrate of the remote control device to match with those of the speed dome.
	2. The wire RS485+ connects to the interface RS485- and wire RS485- connects to the interface RS485+.	2. Connect the wire RS485+ to the interface RS485+ and wire RS485- to the interface RS485-.
	3. The RS485 wire is disconnected.	3. Reconnect the RS485 wire tightly.
	4. RS485 wire is broken.	4. Change a RS485 wire.
The speed	1. The connection is loose.	1. Reconnect the RS485 wire

<b>Problem</b>	<b>Possible Reasons</b>	<b>To Solve the Problem</b>
dome can be controlled but not smoothly.		tightly.
	2. RS485+ or RS485-wire is broken.	2. Change a RS485 wire.
	3. The speed dome is too far away from the remote control device.	3. Add a terminal resistor.
	4. Too many speed domes are connected.	4. Add a RS485 distributor.

### Appendix 3 24VAC Wire Gauge & Transmission Distance

The following table describes the recommended Max. distance adopted for the certain wire gauge when the loss rate of 24VAC voltage is less than 10%. For the AC driven device, the maximum voltage loss rate is 10% allowable. For example, for a device with the rating power of 80VA which is installed at a distance of 35 feet (10m) away from the transformer, then 0.8000mm is required as the minimum wire gauge.

Distance (feet) \ Wire Gauge (mm) \ Power (va)	0.8000	1.000	1.250	2.000
10	283(86)	451(137)	716(218)	1811(551)
20	141(42)	225(68)	358(109)	905(275)
30	94(28)	150(45)	238(72)	603(183)
40	70(21)	112(34)	179(54)	452(137)
50	56(17)	90(27)	143(43)	362(110)
60	47(14)	75(22)	119(36)	301(91)
70	40(12)	64(19)	102(31)	258(78)
80	35(10)	56(17)	89(27)	226(68)
90	31(9)	50(15)	79(24)	201(61)
100	28(8)	45(13)	71(21)	181(55)
110	25(7)	41(12)	65(19)	164(49)
120	23(7)	37(11)	59(17)	150(45)
130	21(6)	34(10)	55(16)	139(42)
140	20(6)	32(9)	51(15)	129(39)
150	18(5)	30(9)	47(14)	120(36)
160	17(5)	28(8)	44(13)	113(34)
170	16(4)	26(7)	42(12)	106(32)
180	15(4)	25(7)	39(11)	100(30)
190	14(4)	23(7)	37(11)	95(28)
200	14(4)	22(6)	35(10)	90(27)

## Appendix 4 Wire Gauge Standards

Bare Wire Gauge(mm)	American Wire Gauge AWG	British Wire Gauge SWG	Cross-sectional Area of Bare Wire(mm <sup>2</sup> )
0.750	21		0.4417
0.800	20	21	0.5027
0.900	19	20	0.6362
1.000	18	19	0.7854
1.250	16	18	1.2266
1.500	15	17	1.7663
2.000	12	14	3.1420
2.500			4.9080
3.000			7.0683



First Choice for Security Professionals