



USER GUIDE



DRANETZ
1000 New Durham Road
Edison, New Jersey 08818-4019



WARNING

Death, serious injury, or fire hazard could result from improper connection of this instrument. Read and understand this manual before connecting this instrument. Follow all installation and operating instructions while using this instrument.

Connection of this instrument must be performed in compliance with the National Electrical Code (ANSI/NFPA 70-2014) of USA and any additional safety requirements applicable to your installation.

Installation, operation, and maintenance of this instrument must be performed by qualified personnel only. The National Electrical Code defines a qualified person as “one who has the skills and knowledge related to the construction and operation of the electrical equipment and installations, and who has received safety training on the hazards involved.”

Qualified personnel who work on or near exposed energized electrical conductors must follow applicable safety related work practices and procedures including appropriate personal protective equipment in compliance with the Standard for Electrical Safety Requirements for Employee Workplaces (ANSI/NFPA 70E-2012) of USA and any additional workplace safety requirements applicable to your installation.

Published by Dranetz
1000 New Durham Road
Edison, NJ 08818-4019 USA
Telephone: 1-800-372-6832 or 732-287-3680
Fax: 732-248-1834
Web site: www.dranetz.com

Copyright© 2015 Dranetz
All rights reserved.

No part of this book may be reproduced, stored in a retrieval system, or transcribed in any form or by any means—electronic, mechanical, photocopying, recording, or otherwise—without prior written permission from the publisher, Dranetz, Edison, NJ 08818-4019.

Printed in the United States of America.

P/N UG-HDPQ Rev. C

ADVERTENCIA

Una conexión incorrecta de este instrumento puede producir la muerte, lesiones graves y riesgo de incendio. Lea y entienda este manual antes de conectar. Observe todas las instrucciones de instalación y operación durante el uso de este instrumento.

La conexión de este instrumento a un sistema eléctrico se debe realizar en conformidad con el Código Eléctrico Nacional (ANSI/NFPA 70-2014) de los E.E.U.U., además de cualquier otra norma de seguridad correspondiente a su establecimiento.

La instalación, operación y mantenimiento de este instrumento debe ser realizada por personal calificado solamente. El Código Eléctrico Nacional define a una persona calificada como "una que esté familiarizada con la construcción y operación del equipo y con los riesgos involucrados."

El personal cualificado que trabaja encendido o acerca a los conductores eléctricos energizados expuestos debe seguir prácticas y procedimientos relacionados seguridad aplicable del trabajo incluyendo el equipo protector personal apropiado en conformidad con el estándar para los requisitos de seguridad eléctricos para los lugares de trabajo del empleado (ANSI/NFPA 70E-2012) de los E.E.U.U. y cualquier requisito de seguridad adicional del lugar de trabajo aplicable a su instalación.

AVERTISSEMENT

Si l'instrument est mal connecté, la mort, des blessures graves, ou un danger d'incendie peuvent s'en suivre. Lisez attentivement ce manuel avant de connecter l'instrument. Lorsque vous utilisez l'instrument, suivez toutes les instructions d'installation et de service.

Cet instrument doit être connecté conformément au National Electrical Code (ANSI/NFPA 70-2014) des Etats-Unis et à toutes les exigences de sécurité applicables à votre installation.

Cet instrument doit être installé, utilisé et entretenu uniquement par un personnel qualifié. Selon le National Electrical Code, une personne est qualifiée si "elle connaît bien la construction et l'utilisation de l'équipement, ainsi que les dangers que cela implique".

Le personnel qualifié qui travaillent dessus ou s'approchent des conducteurs électriques activés exposés doit suivre des pratiques en matière et des procédures reliées par sûreté applicable de travail comprenant le matériel de protection personnel approprié conformément à la norme pour des conditions de sûreté électriques pour les lieux de travail des employés (ANSI/NFPA 70E-2012) des Etats-Unis et toutes les conditions de sûreté additionnelles de lieu de travail applicables à votre installation.

WARNUNG

Der falsche Anschluß dieses Gerätes kann Tod, schwere Verletzungen oder Feuer verursachen. Bevor Sie dieses Instrument anschließen, müssen Sie die Anleitung lesen und verstanden haben. Bei der Verwendung dieses Instruments müssen alle Installation- und Betriebsanweisungen beachtet werden.

Der Anschluß dieses Instruments muß in Übereinstimmung mit den nationalen Bestimmungen für Elektrizität (ANSI/NFPA 70-2014) der Vereinigten Staaten, sowie allen weiteren, in Ihrem Fall anwendbaren Sicherheitsbestimmungen, vorgenommen werden.

Installation, Betrieb und Wartung dieses Instruments dürfen nur von Fachpersonal durchgeführt werden. In dem nationalen Bestimmungen für Elektrizität wird ein Fachmann als eine Person bezeichnet, welche "mit der Bauweise und dem Betrieb des Gerätes sowie den dazugehörigen Gefahren vertraut ist."

Qualifiziertes Personal, das an bearbeiten oder herausgestellte angezogene elektrische Leiter sich nähern, muß anwendbare Sicherheit bezogener Arbeit Praxis und Verfahren einschließlich passende persönliche schützende Ausrüstung gemäß dem Standard für elektrische Sicherheitsauflagen für Angestellt-Arbeitsplätze (ANSI/NFPA 70E-2012) der Vereinigten Staaten und alle zusätzlichen Arbeitsplatzsicherheitsauflagen folgen, die auf Ihre Installation anwendbar sind.

Safety Summary

Definitions WARNING statements inform the user that certain conditions or practices could result in loss of life or physical harm.

CAUTION statements identify conditions or practices that could harm the HDPQ Explorer, its data, other equipment, or property.

NOTE statements call attention to specific information.

Symbols The following International Electrotechnical Commission (IEC) symbols are marked on the top and rear panel in the immediate vicinity of the referenced terminal or device:



Caution, refer to accompanying documents (this manual).



Direct current (DC) operation of the terminal or device.



Power Switch

Definiciones Las ADVERTENCIAS informan al usuario de ciertas condiciones o prácticas que podrían producir lesiones mortales o daño físico.

Las PRECAUCIONES identifican condiciones o prácticas que podrían dañar la HDPQ Explorer, sus datos, otros equipos o propiedad.

Las NOTAS llaman la atención hacia la información específica.

Símbolos Los siguientes símbolos de la Comisión Internacional Electrotécnica (IEC) aparecen marcados en el panel superior y el posterior inmediatos al terminal o dispositivo en referencia:



Precaución, consulte los documentos adjuntos (este manual).



Operación de corriente continua (CC) del terminal o dispositivo.



Interruptor de encendido

Continued on next page

Safety Summary, Continued

Définitions

Les messages d'AVERTISSEMENT préviennent l'utilisateur que certaines conditions ou pratiques pourraient entraîner la mort ou des lésions corporelles.

Les messages de MISE EN GARDE signalent des conditions ou pratiques susceptibles d'endommager "HDPQ Xplorer", ses données, d'autres équipements ou biens matériels.

Les messages NOTA attirent l'attention sur certains renseignements spécifiques.

Symboles

Les symboles suivants de la Commission électrotechnique internationale (CEI) figurent sur le panneau arrière supérieur situé à proximité du terminal ou de l'unité cité:



Mise en garde, consultez les documents d'accompagnement (ce manual).



Fonctionnement du terminal ou de l'unité en courant continu (CC).



Interrupteur de tension

Definitionen

WARNUNGEN informieren den Benutzer darüber, daß bestimmte Bedingungen oder Vorgehensweisen körperliche oder tödliche Verletzungen zur Folge haben können.

VORSICHTSHINWEISE kennzeichnen Bedingungen oder Vorgehensweisen, die zu einer Beschädigung von HDPQ Xplorer, seiner Daten oder anderer Geräte bzw. von Eigentum führen können.

Symbole

HINWEISE machen auf bestimmte Informationen aufmerksam.

Die folgenden Symbole der Internationalen Elektrotechnischen Kommission (International Electrotechnical Commission; IEC) befinden sich auf der Abdeck- und Seitenplatte unmittelbar am betreffenden Terminal oder Gerät.



Vorsichtshinweis, siehe Begleitdokumente (dieses Handbuch).



Gleichstrombetrieb im Terminal oder Gerät.



Netzschalter

Continued on next page

Safety Summary, Continued

Safety precautions

The following safety precautions must be followed whenever any type of voltage or current connection is being made to the HDPQ Xplorer.

- Review NFPA 70-E Standard for Electrical Safety Requirements for Employee Workplaces for applicable safety requirements for potential electrical hazards that may be encountered.
- Wear proper Personal Protective Equipment, including safety glasses and insulated gloves when making connections to power circuits.
- Hands, shoes and floor must be dry when making any connection to a power line.
- Before each use, inspect all cables for breaks or cracks in the insulation. Replace immediately if defective.
- Press the HDPQ Xplorer On/Off power switch to Off.
- Before connecting to electric circuits to be monitored, open their related circuit breakers or disconnects. DO NOT install any connection of the HDPQ Xplorer to live power lines.
- Connections must be made to the HDPQ Xplorer first, then connect to the circuit to be monitored.
- If the equipment is used in a manner not specified in this User Guide, the protection provided by the equipment may be impaired.

These safety precautions are repeated where appropriate throughout this manual.

Statements and Notices

Statement of warranty

All Dranetz manufactured portable instruments and accessories are warranted to the original purchaser against defective material and workmanship for a period of three years from the date of invoice. User replaceable instrument batteries are warranted for a period of one year from the date of invoice. Certain Dranetz branded accessories, such as current transformers and other accessories not manufactured by Dranetz, are warranted to the original purchaser against defective material and workmanship for a period of one year from the date of invoice. Warranties for products and accessories sold by, but not branded as Dranetz, are covered by their respective manufacturer's warranties and are not warranted by Dranetz. Dranetz will repair or replace, at its option, all defective equipment that is returned, freight prepaid, during the warranty period. There will be no charge for repair, provided there is no evidence that the equipment has been mishandled or abused. This warranty shall not apply to any defects resulting from improper or inadequate maintenance, buyer-supplied hardware/software interfacing, unauthorized modification or misuse of the equipment, operation outside of environmental specifications, or improper site preparation or maintenance.

Statement of reliability

The information in this manual has been reviewed and is believed to be entirely reliable. However, no responsibility is assumed for any inaccuracies. All material is for informational purposes only, and is subject to change without prior notice.

Notice regarding FCC compliance

This device has been tested and found to comply with the limits for a Class A digital device, pursuant to Part 15 of the FCC Rules. These limits are designed to provide reasonable protection against harmful interference when the equipment is operated in a commercial environment. This equipment generates, uses, and can radiate radio frequency energy and, if not installed and used in accordance with the instruction manual, may cause harmful interference to radio communications. Operation of this equipment in a residential area is likely to cause harmful interference in which case the user will be required to correct the interference at his/her own expense.

Notice regarding proprietary rights

This publication contains information proprietary to Dranetz. By accepting and using this manual, you agree that the information contained herein will be used solely for the purpose of operating equipment of Dranetz.

Continued on next page

Statements and Notices, Continued

Copyright

This publication is protected under the Copyright laws of the United States, Title 17 et seq. No part of this publication may be reproduced, transmitted, transcribed, stored in a retrieval system, or translated into any language or computer language, in any form, by any means, electronic, mechanical, magnetic, optical, chemical, manual, or otherwise, without the prior written consent of Dranetz, 1000 New Durham Road, Edison, New Jersey 08818.

Copyright © 2015 Dranetz
All Rights Reserved. Printed in the United States of America.

Trademarks

Dranetz HDPQ[®], Scope Mode[®] and Dran-View[®] are registered trademarks of Dranetz.

Other trademarks and trade names are those of their respective owners.

Table of Contents

Safety Summary	iv
Statements and Notices.....	vii
CHAPTER 1 - Getting Started	
Overview	1-1
Unpacking the HDPQ Xplorer	1-3
Standard Accessories.....	1-4
HDPQ Xplorer Controls, Indicators, and Connectors	1-5
Top View.....	1-6
Left Side View	1-7
Right Side View	1-8
Front View	1-9
Rear View	1-10
Keyhole Mounting Procedure.....	1-11
Upgrading Firmware.....	1-12
HDPQ Xplorer UI Touchscreen Features.....	1-14
Touchscreen Functions	1-14
Taskbar Icons	1-15
Instrument Control Functions	1-15
Monitoring Status Functions.....	1-18
Housekeeping Functions	1-19
General Navigation Functions	1-21
HDPQ Xplorer Touch Icon Buttons	1-22
Basic Operation	1-23
Power-on Sequence.....	1-24
Home Start-up Page	1-25
Home Monitoring Page.....	1-25
CHAPTER 2 - Voltage Measurement Cable and Current Probe Connections	
Overview	2-1
Connecting Voltage Measurement Cables	2-4
Connecting Current Probes.....	2-10
CHAPTER 3 - Real Time Data	
Overview	3-1
Section A -Dial Meters.....	3-3
Overview	3-3
Section B -Text Display Meters.....	3-5
Overview	3-5
Standard Meter Tab	3-6
Distortion Meter Tab	3-8
Unbalance Meter Tab	3-9

Table of Contents, Continued

Advanced Meter Tab	3-10
Advanced Demand & Energy Meter Tab	3-11
Advanced Flicker Meter Tab	3-14
Section C -Scope Mode.....	3-15
Overview	3-15
Turning Channels On/Off.....	3-16
Viewing Plots - Stacked/Overlay	3-17
Checking Input Range	3-18
Section D -Dashboard	3-19
Overview	3-19
Parameter Details in Dashboard Display.....	3-22
Section E -Voltage and Current Phasor	3-30
Overview	3-30
Phasor Screen	3-31
Phasor Rotation.....	3-32
Phasor Channel/Parameter Selection.....	3-34
Section F -Harmonics.....	3-35
Overview	3-35
Harmonic Channel/Parameter Selection.....	3-37
Harmonic Graph/Table	3-38
Harmonic Detail	3-40
Harmonic Options.....	3-41
Section G -Strip Chart Recorder	3-43
Overview	3-43
 CHAPTER 4 - Setup Monitoring	
Overview	4-1
Section A -Automatic Setup for Power Quality.....	4-4
Overview	4-4
Section B -Automatic Setup for Energy/Demand	4-7
Overview	4-7
Section C -Wizard Setup.....	4-10
Overview	4-10
Current Probes - Turns Ratios Setup	4-14
Circuit Type Selection.....	4-17
Nominal Values	4-18
Monitoring Mode.....	4-21
Trigger Limits Setup Options	4-22
RMS Variation	4-23
Transients.....	4-27
Set Peak Transients	4-28
Set Waveshape Transients	4-30

Table of Contents, Continued

Set RMS Distortion	4-31
Set High Frequency Transients.....	4-32
Waveform Capture	4-33
Timed Intervals.....	4-35
Journal Limits.....	4-38
Voltage Compliance EN50160 (for strict EN50160 Monitoring).....	4-44
Finalize Monitoring.....	4-46
Exit Setup	4-48
Section D -Monitor Same Circuit	4-49
Overview	4-49
Turn Monitoring On/Off.....	4-50
View/Save Setup Configuration	4-54
Section E -Load Setup Template.....	4-55
Section F -Load Data File from Memory.....	4-56
Section G -Change Instrument Configuration.....	4-58
Section H -View/Save Monitoring Setup.....	4-59
 CHAPTER 5 - Instrument Settings	
Overview	5-1
Time and Date Settings.....	5-3
Select Language.....	5-6
Communications Options	5-7
Set Up the HDPQ Xplorer for Wireless (WiFi) Connectivity.....	5-15
Set Up the HDPQ Xplorer for Bluetooth Connectivity.....	5-19
Download Data Remotely via Network, WiFi & Bluetooth PAN	5-21
Download Data via USB Connection.....	5-22
Manage Memory.....	5-23
Update Firmware	5-25
Setup Sound.....	5-28
Setup Display.....	5-29
Reset to Factory Defaults	5-30
 CHAPTER 6 - View Event Data & Reports	
Overview	6-1
Section A -Trend.....	6-6
Overview	6-6
Trend Plot.....	6-7
Trend Plot with Event Markers	6-15
Section B -Events.....	6-17
Overview	6-17
Event List.....	6-18

Table of Contents, Continued

Event Plot - RMS.....	6-22
Event Waveform.....	6-28
Section C -Reports	6-34
Overview	6-34
Voltage Compliance Report	6-35
Compliance History.....	6-37
Compliance Summary	6-39
EN50160 Compliance Limits (Default)	6-43
Event Statistics.....	6-46
Min/Max Table for Power Frequency and RMS Voltage	6-48
Energy & Demand Report	6-49
Harmonics Statistics Report	6-51
Mini-Report Viewer	6-53
APPENDIX A - Optional Accessories	
Overview	A-1
Hardware Accessories List & Descriptions.....	A-2
Software Accessories List & Descriptions.....	A-8
APPENDIX B - Technical Specifications	
Overview	B-1
General.....	B-2
Interfaces	B-3
Measured Parameters.....	B-4
Computed Parameters.....	B-6
Parameter Settings in Each Monitoring Mode	B-10
Current Probe Specifications	B-12
TR Series Probes.....	B-12
PR Series Probes	B-12
DRANFLEX300MHB Series Probes.....	B-13
DRANFLEX3000XLB/6000XLB Series Probes.....	B-13
APPENDIX C - Battery Specifications and Replacement Procedure	
Overview	C-1
Battery Specifications.....	C-2
Battery Safety Precautions.....	C-3
Battery Pack Replacement.....	C-4
APPENDIX D - User Replaceable Parts List	
Overview	D-1

Table of Contents, Continued

APPENDIX A - Common Circuit Connections

Overview	E-1
Verifying Voltage and Current Connections	E-5
Interconnect Jumpers	E-7
Single Phase	E-8
Split Phase	E-9
3 Phase, Four Wire Wye	E-10
3 Phase (Floating or Grounded) Delta	E-11
3 Phase 2-Watt Delta	E-12
Generic Circuit	E-13
2 1/2 Element Without Voltage Channel B	E-14
2 1/2 Element Without Voltage Channel C	E-15
Connecting to a Potential Transformer (PT)	E-16
Connecting to a Current Transformer (CT)	E-18

APPENDIX B - PQ Parameter Calculations

Calculations	F-1
--------------------	-----



Dranetz HDPQ[®] Xplorer

CHAPTER 1



Getting Started

Overview

HDPQ description

HDPQ[®] is Dranetz' new, advanced power quality instrument designed to facilitate monitoring, recording and display of data on four voltage channels and four current channels simultaneously. The HDPQ instrument builds upon the popular Dranetz PX5/4400 family products, with more user-centric power quality management functionalities and versatile communication options.

There are four Dranetz models of the handheld/portable HDPQ platform from which you can choose from, depending on your application, that impacts what data and information is displayed:



HDPQ[®] Xplorer
HDPQ[®] Xplorer-400
HDPQ[®] Guide
HDPQ[®] Visa

The trademark shown is hereinafter referred to as HDPQ throughout this User Guide. The Xplorer, Xplorer-400, Guide and Visa are portable, hand-held, eight-channel power quality meter/monitors which are very similar in operation, although the Xplorer also has a high speed sampling board for capturing the details of very fast transients.

NOTE: This User Guide provides information on the features and functionalities for Dranetz model HDPQ Xplorer. Functionalities of other product models are each specified in its own user guide. For inquiries contact the Dranetz Customer Service Department at (732) 287-3680 or 1-800-372-6832.

HDPQ Xplorer user interface

The HDPQ Xplorer portable, hand-held, eight-channel power quality and energy meter/monitor is capable for use on three user interface (UI):

- Local/LCD Touchscreen UI - with a WVGA wide screen liquid crystal display (LCD), using touch screen technology.

NOTE: This User Guide provides information on this local user interface, which includes the touch screen, LCD, and three touch buttons below the screen. The other interfaces below may differ due to size and device capabilities, and are to be specified in a separate document.

Continued on next page

HDPQ Xplorer user interface (continued)

- Remote UI - uses the remote desktop communication and other “apps” on personal computers/laptops/tablets. Remote navigation using a computing device with a full size screen such as laptop computer, desktop computer or tablet computer, typically 7" or larger display. The remote UI allows for complete control of the instrument to the full extent of the instrument capabilities, including on screen 'touch' controls and the three touch buttons below the display. On remote PCs with a keyboard, the F1,F2 and F3 shortcut keys map to the instrument's report and help panel buttons. Major differences between local and remote UI is in the navigation and controls that are different on the instrument’s touch screen versus mouse clicks on personal computer or laptop. On tablets, some of the controls used for screen navigation do not apply.
- Remote Mobile UI - uses personal communication devices such as mobile and smart phones. Compatible with devices such as Smartphone or equivalent devices with small, typically 3” to 4" display. The capabilities are based on various “apps” that the user can download from the Dranetz web site, like viewing real time and stored data in a format compatible with smaller display.

HDPQ Xplorer firmware

The firmware for HDPQ Xplorer is contained on internal FLASH memory. It has an operating system capable of performing multiple applications. When an updated version of the firmware is released, you can upgrade the internal program by downloading the latest firmware version. **See page 1-12 for instructions on how to upgrade the HDPQ Xplorer firmware.**

This manual

This manual contains instructions for operating HDPQ Xplorer with the local/LCD touchscreen user interface.

In this chapter

The following topics are covered in this chapter.

Topic	See Page
Unpacking the HDPQ Xplorer	1-3
Standard Accessories	1-4
HDPQ Xplorer Controls, Indicators, and Connectors	1-5
Keyhole Mounting Procedure	1-11
Upgrading Firmware	1-12
HDPQ Xplorer UI Touchscreen Features	1-14
HDPQ Xplorer Touch Icon Buttons	1-22
Basic Operation	1-23

Unpacking the HDPQ Xplorer

Introduction For maximum protection against possible shipping damage, HDPQ Xplorer has been sealed in a two-piece, plastic suspension pack, enclosed within a durable shipping carton. After opening the carton, inspect the contents for possible shipping damage and check the carton inventory.

Unpacking Unpack the HDPQ Xplorer from the carton as follows:

Step	Action
1	Remove any remaining literature inside the top of the carton.
2	Carefully remove the HDPQ Xplorer from its shipping carton.
3	Remove all accessories inside the carton. Check that all of the standard accessories (see page 1-4) are included.

Shipping damage inspection Visually inspect the HDPQ Xplorer for possible shipping damage. If any damage exists, first notify and file an insurance claim with your carrier or underwriter or both. Then notify Dranetz Customer Service Department of your intentions to return the unit. DO NOT return the HDPQ Xplorer without prior instructions from Dranetz Customer Service Department. Dranetz Customer Service Department can be reached at (732) 287-3680 or 1-800-372-6832.

Repacking for return shipment If the unit must be returned to Dranetz for service or repair, wrap the unit securely in heavy packaging material and place in a well padded box or crate to prevent damage. Do not return the HDPQ Xplorer in an unpacked box. Dranetz will not be responsible for damage incurred during transit due to inadequate packing on your part.

Return notice Notify Dranetz Customer Service of your intention of returning the unit. Do not return the unit without prior instructions from Dranetz. Dranetz Customer Service Department can be reached at (732) 287-3680 or 1-800-372-6832.

Standard Accessories

Standard accessories

The following table lists the HDPQ Xplorer's standard accessories.

Description	Part Number
Voltage Cable Set	VSC-HDPQ
AC Adapter with Universal Plugs	PS-HDPQ
Keyhole Mounting Kit	118313-G1
USB Cable, Male A to Micro B, 6 FT	USB-MCABLE
USB to Bluetooth 2.1 Adapter - Class 1*	USB-BLUETOOTH
HDPQ Xplorer Quick Reference Guide	QR-HDPQ
HDPQ Xplorer User Guide	UG-HDPQ

* The Dranetz Bluetooth external adapter is packaged as a standard accessory for the HDPQ Xplorer, Xplorer-400 and Guide. While it is available as an optional accessory for the HDPQ Visa.

Optional accessories

Refer to Appendix A for the list of hardware and software optional accessories available for use with HDPQ Xplorer.

Batteries

Refer to Appendix C for the description and replacement of the batteries contained in HDPQ Xplorer.

Replaceable parts

Refer to Appendix D for the user replaceable parts.

Calibration

The recommended calibration interval for this unit is once every 12 months.

We recommend that you return the unit to the factory for calibration. If you decide to do so, first contact the Dranetz Customer Service Department to obtain an Authorization Number.

Telephone: (732) 287-3680 or 1-800-372-6832

FAX: (732) 248-1834

Fill out the Repair/Service Order form enclosed in the shipping carton and ship it along with the unit to the Dranetz Repair Department. (If this form is missing, ask the Dranetz Customer Service Department for a replacement.)

HDPQ Xplorer Controls, Indicators, and Connectors

Dimensions

HDPQ Xplorer is a self-contained, portable instrument weighing less than 5 pounds with 7" (diagonal) WVGA wide screen display and measuring 2.75" (7.00 cm) deep by 10" (25.4 cm) wide by 8" (20.3 cm) high. This section identifies and describes the controls, indicators, and connectors on all sides of the HDPQ Xplorer, shown with rubber boot installed.

Top View



Front View



Rear View



Left Side View (with you facing front panel)



Right Side View (with you facing front panel)



Top view

The top (circuit connection) view features the input voltage and current connectors. See below for description of the top connectors.



Parts table

Part	Function
1	CH A, + Differential Voltage Input Connector; color black.
2	CH A, - Differential Voltage Input Connector; color white.
3	CH B, + Differential Voltage Input Connector; color black.
4	CH B, - Differential Voltage Input Connector; color white.
5	CH C, + Differential Voltage Input Connector; color black.
6	CH C, - Differential Voltage Input Connector; color white.
7	CH D, + Differential Voltage Input Connector; color black.
8	CH D, - Differential Voltage Input Connector; color white.
9	CH A, PROBE, Current Input Connector.
10	CH B, PROBE, Current Input Connector.
11	CH C, PROBE, Current Input Connector.
12	CH D, PROBE, Current Input Connector.

Left side view

The left side contains the power switch, GPS receiver port and AC adapter input connector. See below for descriptions of the left side connectors.

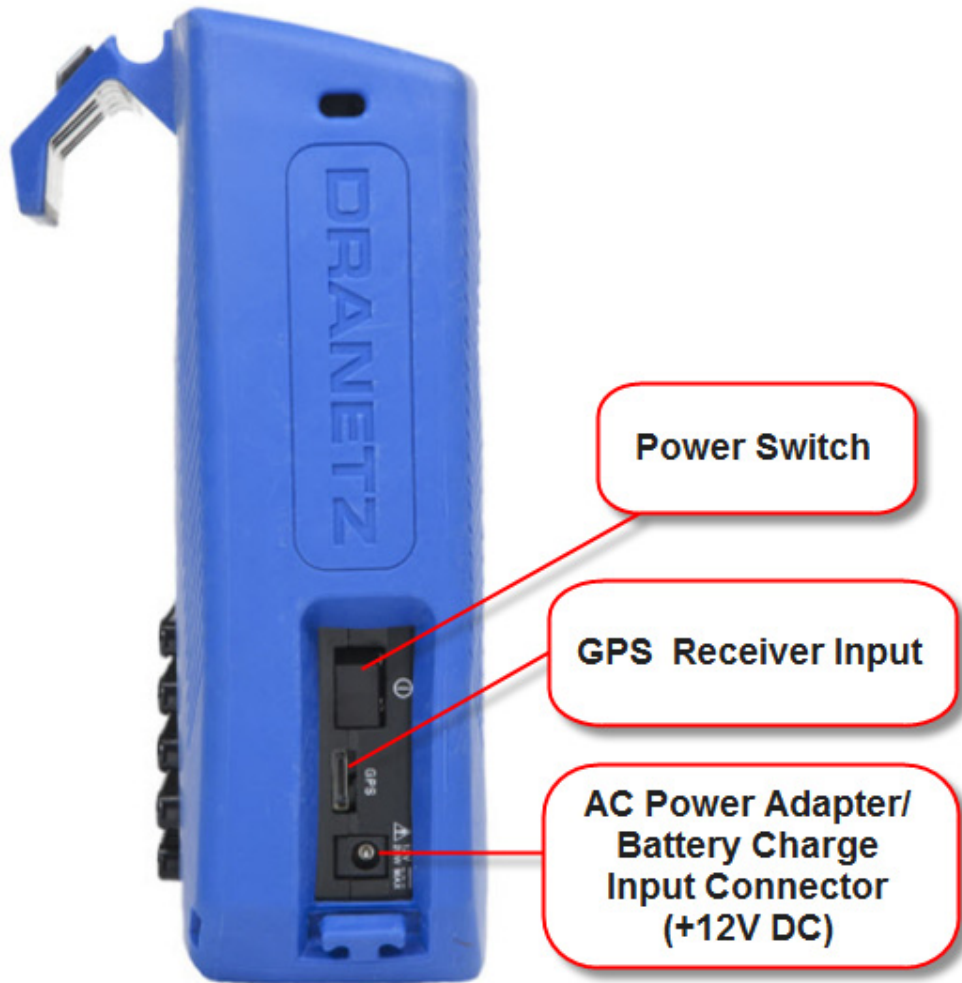

Right side view The right side contains the ethernet port and the two USB port connectors for the USB flash drive and the USB cable for plug & play file transfer directly to a computer. See below for description of the right side connectors.

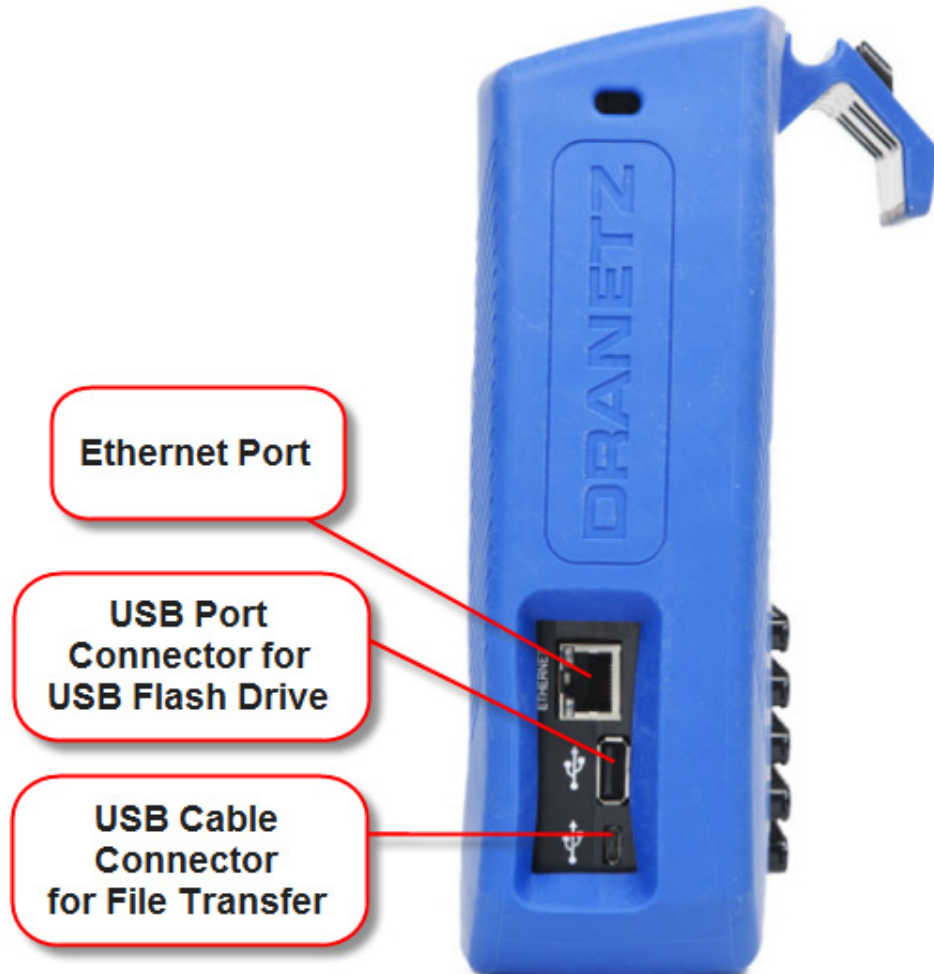

Front view

The front view shows the color touch screen LCD, the LED indicators, and touch icons marked accordingly allowing you to perform functions specific to the screen display. See below for description of the HDPQ Xplorer front display.

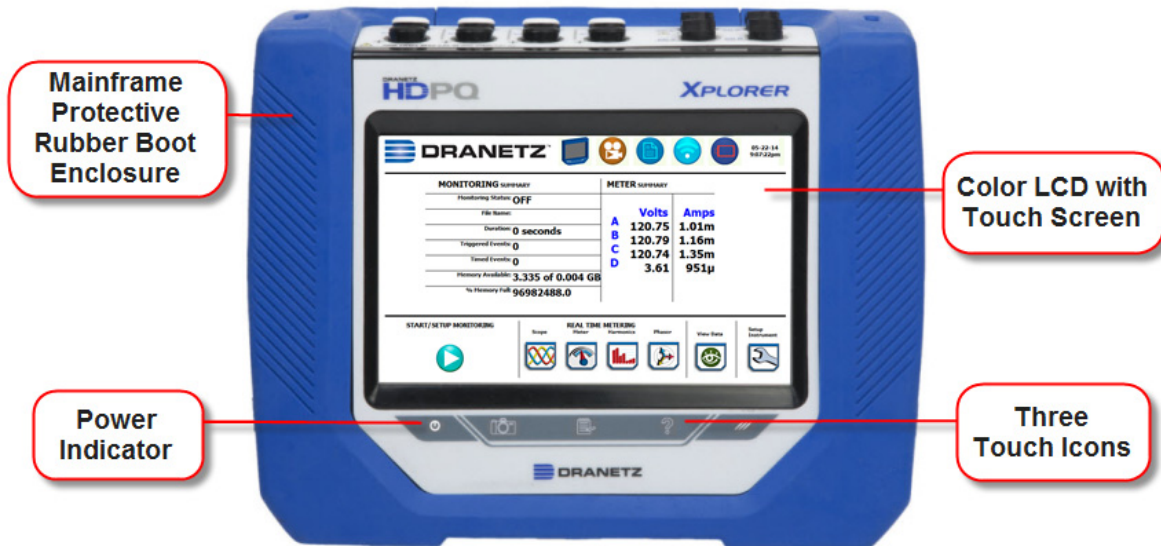

NOTE 1: Liquid Crystal Display (LCD). Provides 3.6 x 6.0 inches display consisting of a WVGA touch screen of text and graphic information. The color LCD is equipped with touch screen technology, operable using the finger and/or stylus. Touch screen display permits menu selection and alphanumeric data entry.

Below are some basic care instructions for the LCD monitor:

- Use and store the unit within the specified temperature and humidity range. The LCD screen may be adversely affected by exposure to high temperature or humidity. Condensation or moisture produced by sudden temperature changes may also damage the LCD screen. Clean any moisture from surface immediately.
- Be careful when cleaning or removing stains on the LCD surface. Gently wipe the surface with a soft cloth or cotton pad. Isopropyl alcohol may be used, but make sure that all solvent residue is removed.
- Do not apply excessive force to the LCD surface. The LCD screen contains sensitive electronic components that may be damaged due to strong impact.

NOTE 2: Power Indicator. LED will light steadily when the unit is operating normally.

NOTE 3: Touch Icons. The three touch icons are used to perform various functions i.e. take a Snapshot of the active screen, capture Mini-Reports and access Help screens. See section HDPQ Xplorer Touch Icons for detailed descriptions. These icons cannot be activated with gloves on as they employ capacitive or touch technology.

Rear view

The rear view shows the mounting hanger bracket on top if you want to hang the instrument on a panel. This hanger bracket has built-in wire coil holders used to put your measurement wirings in place. Note if you do not want to hang the instrument on a panel, the hanger bracket is replaceable with the Dranetz-supplied accessory Keyhole Mounting Kit (P/N 118313-G1). This kit allows you to mount the instrument on the wall or install it in the optional weather resistance enclosure. See next section for details.

The rear view also features a hinge which deploys a stand. The stand also has wire coil holders to help manage your measurement wiring connections. The view below shows the hinge closed.

NOTE: Battery compartment is located under the hinge (bottom area). See Appendix C - Battery Specifications and Replacement Procedure.

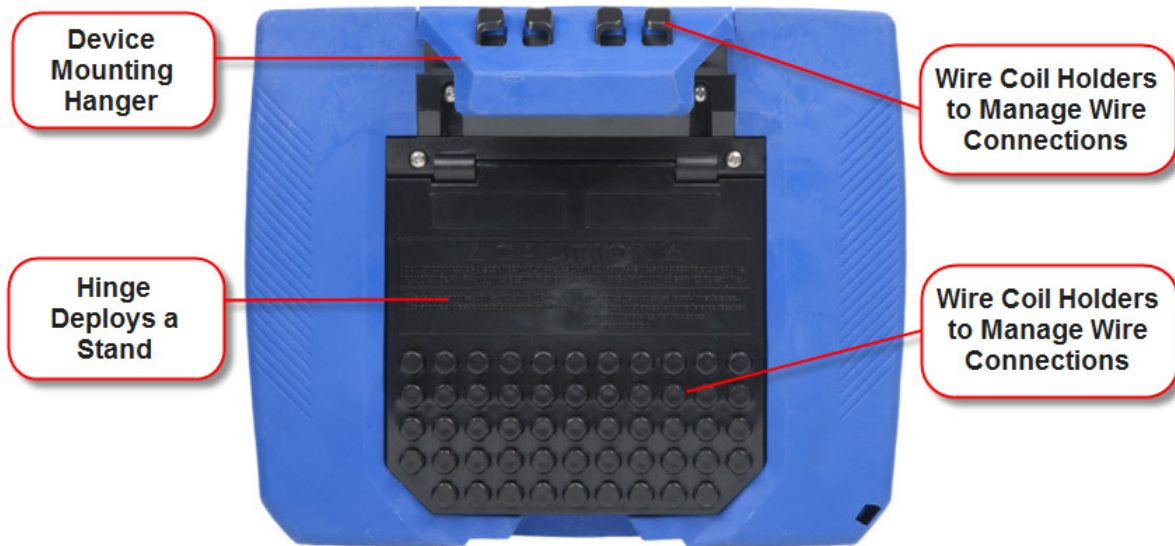

Keyhole Mounting Procedure

Keyhole mounting kit

The Keyhole Mounting Kit (P/N 118313-G1) is a standard accessory that comes with your purchase of the HDPQ Xplorer, Guide, or Visa, and can be used to replace the mounting hanger bracket. Instead of hanging the instrument on a panel, you can use the kit to have the instrument wall mounted or installed in the optional Weather Resistant Enclosure (P/N ENCL-HDPQ). The procedure below shows how to replace the mounting hanger bracket with the keyhole mounting kit.

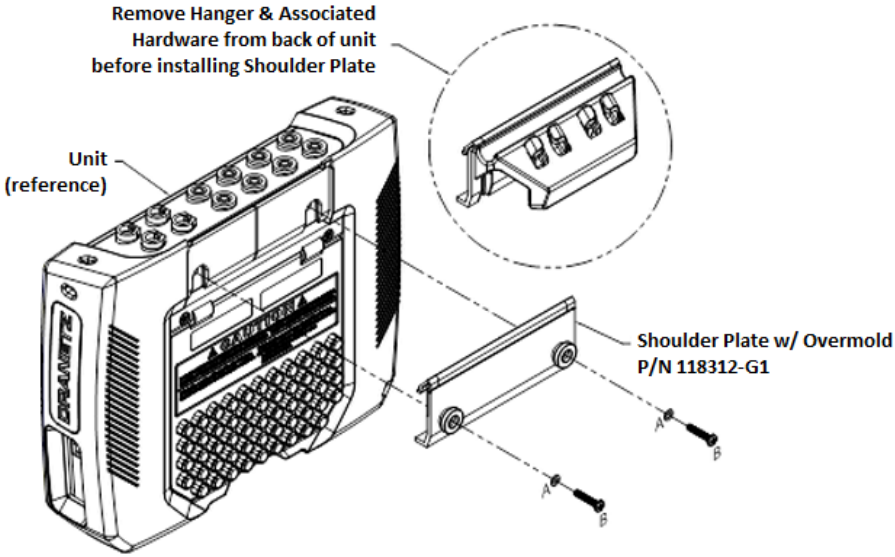
Step	Action
1	Remove the hanger bracket from the instrument by removing two #6-32 x 5/16" long screws and two flat washers from the hanger bracket.
2	<p>Replace the hanger bracket with the keyhole mounting plate (P/N 118312-G1) and secure it to the instrument with the supplied hardware (two #6-32 x 3/4" inch long screws and two flat washers) as shown below.</p>  <p>The diagram illustrates the process of replacing the hanger bracket. It shows a side view of the instrument labeled 'Unit (reference)'. A callout indicates to 'Remove Hanger & Associated Hardware from back of unit before installing Shoulder Plate'. Below this, a 'Shoulder Plate w/ Overmold P/N 118312-G1' is shown with two screws (labeled A and B) and two flat washers (labeled A and B) for installation.</p>

Contact Dranetz Customer Service if you need information on the optional Weather Resistant Enclosure (P/N ENCL-HDPQ).

Upgrading Firmware

HDPQ Xplorer firmware upgrade

You can upgrade the HDPQ Xplorer internal program by downloading the latest firmware update release from the web to install into internal memory.

Illustration below shows the high level process for updating firmware:

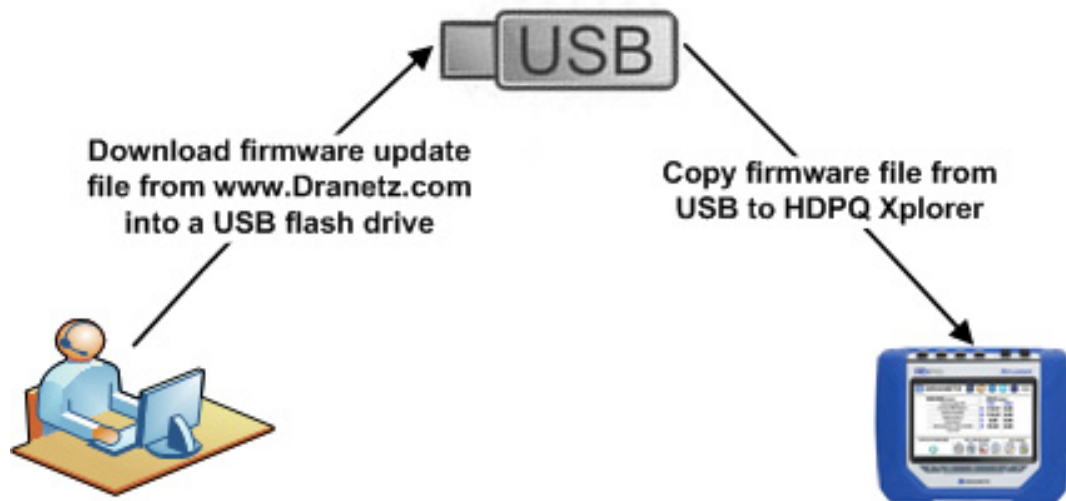

- Download the latest firmware update release from the Dranetz website into the root directory of a USB flash drive.
- Once the firmware file is copied, insert the USB flash drive into the USB connector on the right panel of the instrument.
- Click on the Setup Instrument icon to bring up the Instrument Settings menu, and proceed to press Update Firmware. The following dialog box appears to prompt whether or not you want to upgrade firmware.

Continued on next page

**HDPQ Xplorer
firmware
upgrade
(continued)**

Refer to Chapter 5 Instrument Settings > Update Firmware for the detailed steps on how to upgrade firmware.

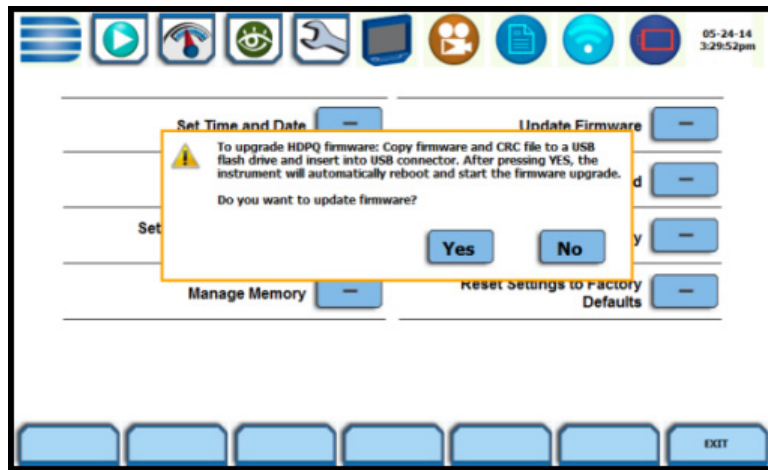

HDPQ-514

HDPQ Xplorer UI Touchscreen Features

Touchscreen functions

All HDPQ Xplorer screen functions are operable using the color LCD touch screen display. Use your finger and/or a stylus to apply light pressure to the LCD screen to result in touch screen recognition. The touch screen display is also workable with lineman gloves on. Touch screen buttons will change color to show visual feedback of contact along with audible feedback. In order to reduce power consumption, the backlight of the LCD screen times-out after a specified programmable time of no user activity. The backlight reactivates by touching any part of the screen.

Sample touchscreen working area window shown below:

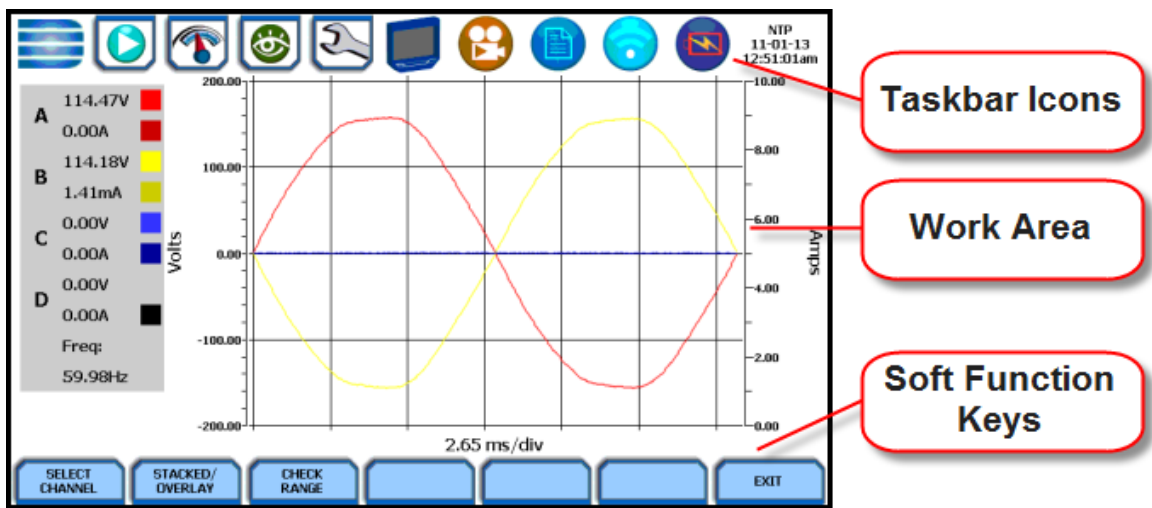

Taskbar Icons

The Taskbar features interactive icon graphics located at the top of the user interface. These icons are used as shortcuts to common instrument functions, status and controls. They are generally used to navigate between different operations of the instrument.

Work Area with Soft Function Keys

Each displayable function will appear in the work window. The work window displays the selected data, function, control, etc.





Depending on the data function on display, the work window may show soft function keys, the definitions of which can change based on the context of the screen. These soft keys are generally used to access sub-menus or pop-up screens as part of the operation of the active screen, such as zoom in/out, data entry, etc. The Exit or Done key typically closes the present viewing screen and returns to the previous screen.

Taskbar icons

Common functions described below are accessible from the taskbar, generally divided into three areas - Instrument Control Functions, Monitoring Status Functions and Housekeeping Functions. The current date and time is also featured on the rightmost side. You can configure date and time settings, discussed on Chapter 5 Instrument Settings - Time and Date Settings.



Instrument control functions

<p>Home</p> 	<p>The Home page displays large shortcuts of the major functions of the instrument once it completes the power on sequence and loads the program and setups. The shortcut buttons include Start Monitoring, Real Time Data, Recorded Data and Instrument Setup. Repeated pressing of the Dranetz logo alternately displays the Home page and the Home Monitoring page.</p>
<p>Start/Stop Monitoring</p>  <p>Start Monitoring</p>  <p>Stop Monitoring</p>	<p>The Start Monitoring shortcut takes you next page to begin setup monitoring. Monitoring may be via Automatic Setup which utilizes auto-configured settings and allows you to proceed directly with data monitoring or via Wizard Setup which follows a step-by-step sequence where you go through a series of setup screens. If monitoring is ON, a warning message will be displayed requiring monitoring to be stopped before invoking. Note the Start Monitoring icon changes into Stop Monitoring when monitoring is on, and vice versa.</p> <p>Menu options to monitor the same circuit, begin monitoring immediately or at a specified time and date, load and view stored setups or data are also available. Setup is a configuration of parameter thresholds that control the data recorded by HDPQ Xplorer.</p>
<p>Real-time Data</p> 	<p>The Real-Time Data displays a menu of available real time meters such as Meters, Scope, Phasors and Harmonics. One instance of this can be invoked while the other screen is open; display will return to the prior screen once closed.</p> <ul style="list-style-type: none"> • Dial Meters - Six dial type meters can be displayed for any of the channel/parameters that are journalled. The default are Va, Vb, Vc, Ia, Ib, Ic. Axis (end points of meter) can be changed on per meter basis, as well as showing the journal limits as bands of colors on the dial face.



Continued on next page

Instrument control functions (continued)

<p>Real-time Data (cont.)</p>	<ul style="list-style-type: none"> • Text Display Meters - Meter mode also functions as a true rms voltmeter, a true rms ammeter, and a watt meter. Voltage, current, power measurements, along with hundreds of other calculated and advanced power and power quality parameters, are displayed on the meter screens in textual/tabular format. • Scope Mode - Scope mode functions as an oscilloscope, displaying real-time waveforms of voltage and current for up to eight channels simultaneously, updated at approximately once every three seconds. The colors of waveform display are user programmable. Scope mode also provides a textual display of rms values, division for axis values, and frequency. • Dashboard - Dashboard presents a visual way of seeing present values as well as if any events occurred, such as out-of-limit conditions, for each of the displayed parameter. The dashboard displays status summary for Power Quality, Energy/Demand, and Motor Quality parameters. It displays meter data (or event count) in a 3x4 matrix. It is also color coded to indicate whether or not the parameter is within limits. • Phasor Diagram - The phasor screen displays a graph that indicates phase and magnitude relations between voltage and current based upon the angles at the fundamental frequency, as determined by Fourier analysis. Phasor diagram displays voltage and current phasors for all channels. Functioning as a phase angle meter, the unit can display system imbalance conditions and provides such information in textual form also. The phase angle display can also verify if monitoring connections have been made correctly. Animated phasor demo rotations demonstrating resistive, inductive and capacitive loads can be displayed. • Harmonics - Harmonics and interharmonics display the amplitude and phase of each harmonic to the 127th harmonic in both graphical and textual format.
-------------------------------	-------------------------------------------------------------------------------------------------------------------------------------------------------------------------------------------------------------------------------------------------------------------------------------------------------------------------------------------------------------------------------------------------------------------------------------------------------------------------------------------------------------------------------------------------------------------------------------------------------------------------------------------------------------------------------------------------------------------------------------------------------------------------------------------------------------------------------------------------------------------------------------------------------------------------------------------------------------------------------------------------------------------------------------------------------------------------------------------------------------------------------------------------------------------------------------------------------------------------------------------------------------------------------------------------------------------------------------------------------------------------------------------------------------------------------------------------------------------------------------------------------------------------------------------------------------------------------------------------------------------------------------------------------------------------------------------------------------------------------------------------------------------------------------------------------------------------------------------------------------------------------------------------------------------------------------------------------------------------------------------------------------------------------------------------------



Continued on next page

**Instrument
control functions
(continued)**

<p>Recorded Data</p> 	<p>Recorded Data displays captured information in either graphic or textual form, including events and trends, along with voltage compliance and mini-reports. These include both trended data and events generated from user programmed triggers or thresholds. One instance of this can be invoked while another screen is open and will return to prior screen upon exit.</p> <ul style="list-style-type: none"> • Trend - You can generate plots for all journalled data combined with min/max recordings of that parameter. Most journal parameters have multiple channels to plot. • Event - An event occurs when a programmed threshold limit is crossed. An event consists of the pre-trigger cycle(s), trigger cycle(s), and post-trigger cycle(s). • Reports - You can view and set up compliance data in various report format, depending on your application: <p>Voltage Quality of Supply (QOS) compliance displays statistical reports based on an analysis of the voltage as per requirements of the EN50160 standard. Compliance data is presented in bar charts, statistical tables, and graphs. Statistical data is calculated on the required parameters specified in EN50160 over one week interval to produce a PASS/FAIL decision of QOS compliance.</p> <p>Energy & Demand Report allows you to monitor demand and energy parameters for energy audits, efficiency studies and cost reduction programs.</p> <p>Harmonics Statistics Report allows you to set up harmonics statistical reports, based on the 3-second data calculating the 95% and 99% values per IEC 61000-4-7 and IEEE 519.</p> <p>Mini-Report Viewer allows you to view, delete or save monitoring setups and/or status into a report file. You can also save the active image on screen and append it to the report as visual aid.</p>
<p>Setup Instrument</p> 	<p>This function covers instrument configuration settings such as time and date display preferences, language selection, communications options, manage memory, firmware upgrade, etc.</p>



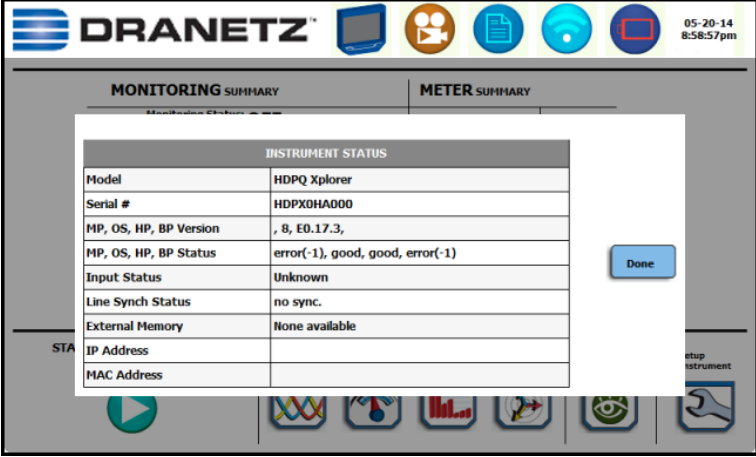

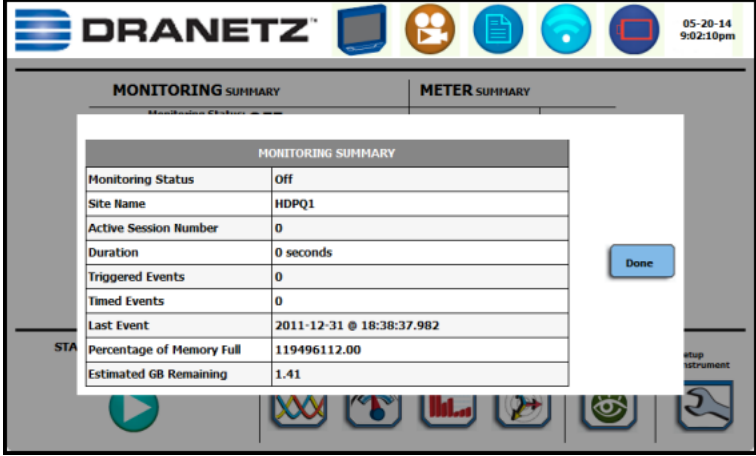
Monitoring status functions

Monitoring status presents the current status of the instrument such as monitoring on/off, errors/warnings, etc. These functions invoke pop-up windows and return to the prior screen upon exit.

<p>Instrument Status</p> 	<p>This window displays status information about the instrument, including versions of firmware, serial number, MAC address, line synch status, input status, the last three error messages. It indicates the health of the instrument and whether or not there is any error or warning conditions that require attention. Example Instrument Status screen shown below.</p>  <p style="text-align: right;">HDPQ-102</p>
<p>Monitoring Summary</p> 	<p>Displays a page showing a summary of the current monitoring session. This window also includes event and timed reading counts, last event, monitoring status and start, percent of memory used and the remaining estimate. Example Monitoring Summary screen shown below.</p>  <p style="text-align: right;">HDPQ-103</p>

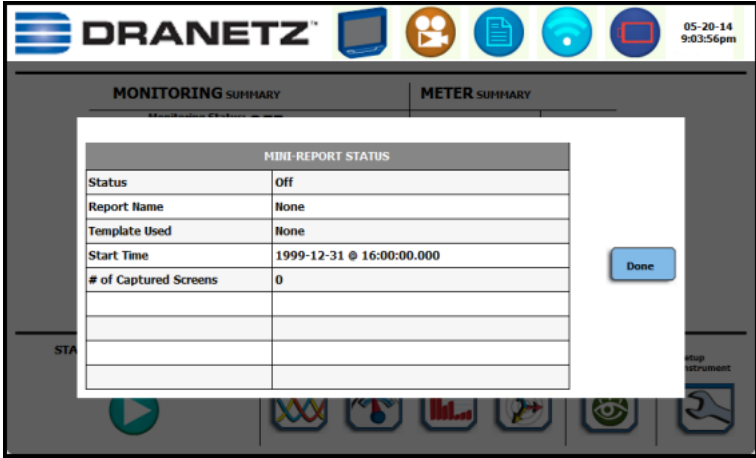



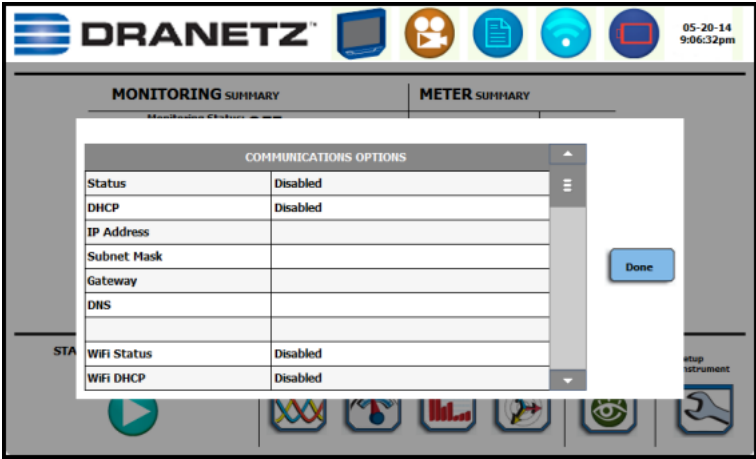



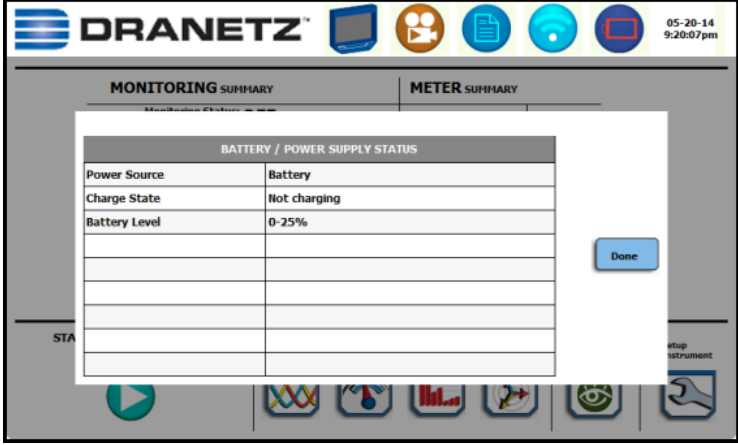

Housekeeping functions

Housekeeping includes generic functions such as mini-report status, Bluetooth or network wireless connection, and power supply/battery gage. These functions invoke pop-up windows and return to the prior screen upon exit.

<p>Mini-Report Status</p> 	<p>Mini-Report Status allows you to view report setups and status.</p>  <p style="text-align: right;">HDPQ-104</p>
<p>Communications Options</p>  <p>Signal strong</p>  <p>Signal weak</p>  <p>Signal unavailable</p>	<p>Press Setup Instrument to configure the instrument's Wireless (WiFi) and Bluetooth communications options. The Xplorer requires the addition of a Dranetz supplied Bluetooth external adapter in order to connect to a wireless-enabled device using the Bluetooth networking mode. The Bluetooth interface uses a PAN network that is only available on PC based devices.</p>  <p style="text-align: right;">HDPQ-105</p>



Continued on next page

Housekeeping functions (continued)

<p>Battery / Power Supply Status</p>	<p>Displays battery charge status when powered externally. Displays battery percent charge remaining when operating from internal battery as well as charging level if power supply is plugged in to a valid AC source.</p>  <p style="text-align: right;">HDPQ-106</p> <p><u>When battery is not charging:</u> Taskbar displays battery icon indicating the percentage of battery life that HDPQ Xplorer has remaining.</p> <div style="display: flex; justify-content: center; align-items: center; gap: 20px;">      </div> <p>Battery life: 100% 75% 50% 25% 0%</p> <p><u>When battery is charging:</u> Taskbar displays battery icon indicating the percentage of battery charge.</p> <div style="display: flex; justify-content: center; align-items: center; gap: 20px;">      </div> <p>Battery charge: 100% 75% 50% 25% 0%</p>
<p>Time/Date</p>	<p>Displays the current time and date. See Chapter 5 Instrument Settings - Time and Date Settings.</p>

General navigation functions

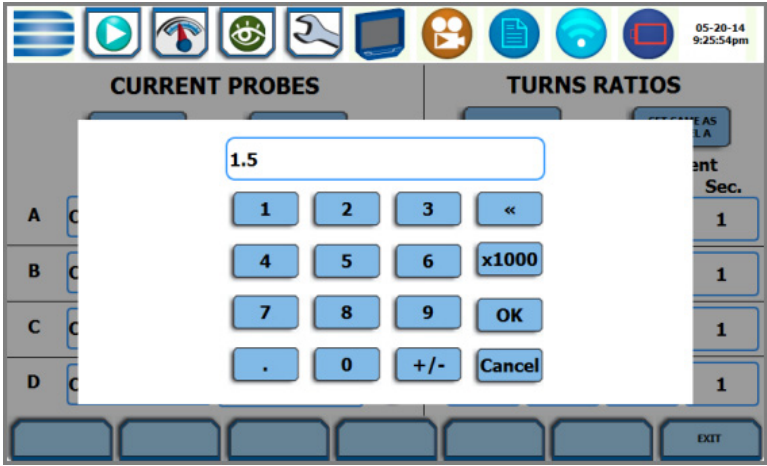
General navigation screens include the numeric and alphanumeric keypads.

<p>Numeric Keypad</p>	<p>Features numeric keypad window for multiple uses. Press a numeric entry field to display the numeric keypad. This keypad also appears automatically when you press a screen that requires numeric entry.</p>  <p style="text-align: right;">HDPQ-107</p>
<p>Alphanumeric Keypad</p>	<p>Features generic alphanumeric keyboard in QWERTY format. Press a text entry field to display the alphanumeric keypad. This keypad also appears automatically when you press a screen that requires text entry.</p>  <p style="text-align: right;">HDPQ-108</p>

HDPQ Xplorer Touch Icon Buttons

Touch icon functions

There are three touch icons located below the LCD screen - Snapshot, Mini-Report Capture and Help. The icon buttons allow you to perform functions specific to the screen on display, as described below:

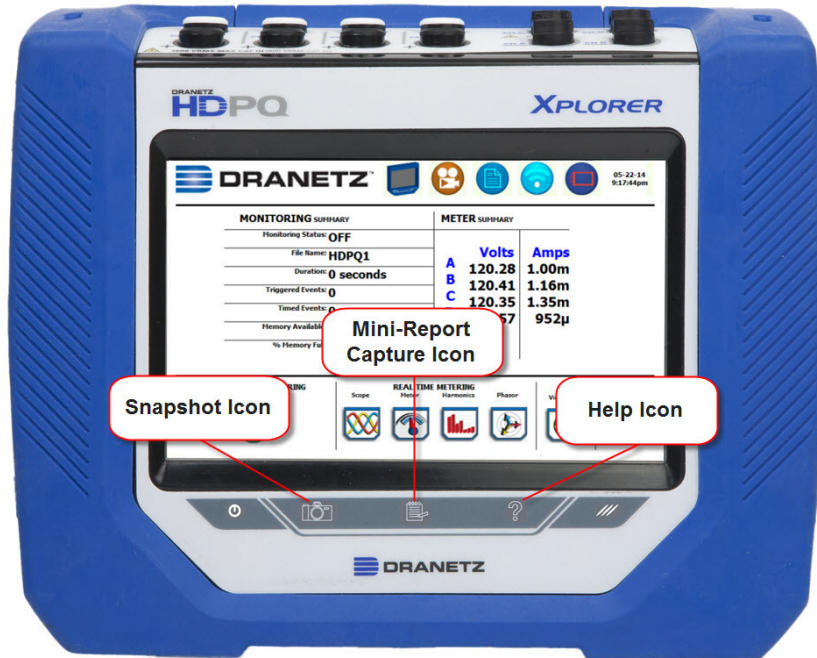

Snapshot Icon

This icon captures the image on the screen as a .bmp file. The captured image includes the top and bottom row of buttons. The instrument appends the captured image to a mini-report if one is open. If no report is open, it saves the image to internal memory as a .bmp file. On Remote VNC connection, press the keyboard F1 shortcut key to activate this function.

Mini-Report Capture Icon

This icon saves the active screen image to a report file. Pressing the left touch icon is similar to doing a Cntrl-PrintScrn on Windows®. It appends the image of the active screen to an open report file. Prior to pressing, use the middle key to open a Mini-Report (see Chapter 6 - Section C Reports - Mini-Report Viewer). Pressing the Mini-Report Capture icon without an open file will bring up the Mini-Report Start menu, which lets you create a new report file. The instrument allows only one (1) file to be opened at a time. Graphics are saved as images in .bmp format while alphanumeric content is saved as xml file. After a report is opened, pressing this icon a second time allows you to close the report list. On Remote VNC connection, press the keyboard F2 shortcut key to activate this function.

Help Icon

This icon allows you to access instant on screen Help. It is context sensitive, in that it displays the pertinent Help information based on the active screen. On Remote VNC connection, press the keyboard F3 shortcut key to activate this function.

Basic Operation

Introduction The normal power source for the HDPQ Xplorer is its internal battery pack. The AC Adapter/Battery Charger is used to charge the battery. Always charge the battery fully before use. HDPQ Xplorer will always operate on the charger and is designed to do so, regardless of the state of charge of the battery.

Battery pack Type: Sealed, rechargeable NiMH (Nickel Metal Hydride) cells.

Length of operation: HDPQ can operate on a fully charged battery pack for approximately three (3) hours of continuous use.

Charging: The battery pack can be charged by connecting the AC Adapter/Battery Charger to the HDPQ Xplorer. A screen warning will appear during operation when battery charge is low. A depleted battery pack can be recharged in three (3) hours whether the unit is on or off. While charging, the taskbar displays a battery icon indicating the percent of battery charge.

AC power source HDPQ Xplorer can be operated from a 50/60 Hz 120/240V AC power source with or without the battery pack installed.

Connect the AC Adapter output cable to the input connector on the left side of the unit. Connect the AC Adapter to an appropriate outlet using the appropriate adapter plug.

Refer to Appendix C for the specifications and replacement of the batteries contained in HDPQ Xplorer.

Power-on sequence

Follow these steps to turn on the HDPQ Xplorer and display the Home page.

Step	Action
1	Connect the AC adapter/battery charger plug into the left side of the instrument.
2	Plug the AC adapter into an AC power source.
3	<p>Press the On/Off power switch located at the left side to turn the instrument on.</p> <p><u>Result:</u> The Dranetz logo will be displayed while the instrument is booting.</p> <div data-bbox="630 642 1308 1052" data-label="Image"> <p>The image shows the Dranetz logo, which consists of a stylized blue 'D' icon followed by the word 'DRANETZ' in a bold, black, sans-serif font.</p> </div> <p style="text-align: right; font-size: small;">HDPQ-109</p>
4	<p>After the instrument completes the power on sequence and loads the program and setups in, the Home screen displays the large shortcut buttons of the major functions of the instrument. This allows you to easily select the first function after power up.</p> <p><u>Result:</u> The Home page will be displayed. The icons represent four main instrument functions: Start Monitoring, Real Time Data, Recorded Data (events, data, reports) and Setup Instrument.</p> <div data-bbox="630 1396 1308 1806" data-label="Image"> <p>The image shows the Dranetz Home screen. At the top, there is a status bar with the Dranetz logo, a tablet icon, a camera icon, a document icon, a Wi-Fi icon, a battery icon, and the date and time '05-22-14 9:47:20pm'. Below the status bar, there are four large, square icons arranged horizontally, each with a label above it: 'Start Monitoring' (a play button icon), 'Real Time Data' (a gauge icon), 'Recorded Data' (an eye icon), and 'Setup Instrument' (a wrench icon).</p> </div> <p style="text-align: right; font-size: small;">HDPQ-110a</p> <p>NOTE: If the instrument was shut down while monitoring, the instrument will resume monitoring upon power up.</p>

Home start-up page

Upon start-up, the Home page serves as the access point for major instrument control functionalities, as described below:

Start Monitoring - You have the option to use Automatic Setup and proceed directly with data monitoring or configure the instrument step-by-step using the Wizard Setup. You can also load previously saved setups or previously saved data from memory. Setup is a configuration of parameter thresholds that control the data recorded by HDPQ Xplorer. See Chapter 4 Setup Monitoring.

Real-Time Data - Displays voltage and current measurements, along with other calculated parameters in different modes. See Chapter 3 Real Time Data.

Recorded Data - Displays recorded data in either graphic or textual form, including events and trends, along with mini-reports and voltage compliance (EN50160) reports. See Chapter 6 View Event Data & Reports.

Setup Instrument - You may perform instrument configuration settings such as time and date display preferences, language selection, communications options, firmware update, etc. See Chapter 5 Instrument Settings.

Home monitoring page

After the instrument has been powered up and monitoring is turned ON (and subsequently if monitoring is DONE), the Home Monitoring page becomes the start-up page. Note the Start Monitoring icon changes into Stop Monitoring when monitoring status is on, and vice versa.

Home Monitoring page allows you to view monitoring status and setups as configured. The taskbar located on top of the screen features shortcuts to common instrument functions. Icons to access real time meters and to view recorded data/reports are found at the bottom of screen. This is the home page from which all other functions launch and eventually return back to using the Exit function key.

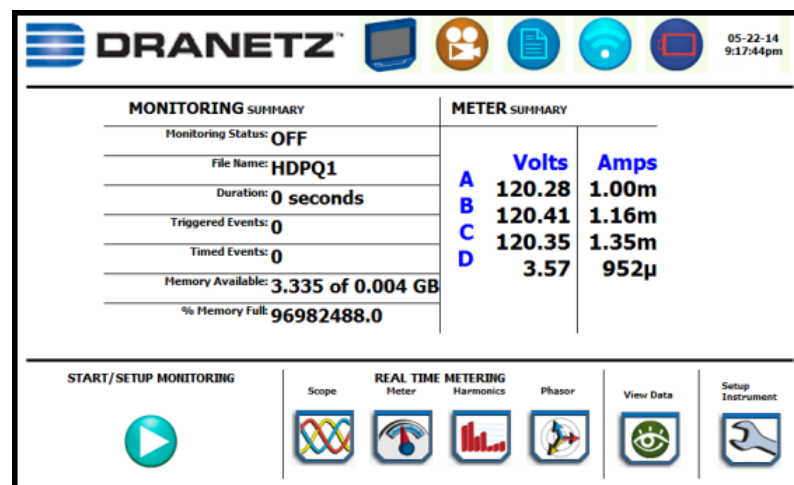

HDPQ-111b

This page intentionally left blank.

CHAPTER 2



Voltage Measurement Cable and Current Probe Connections

Overview

Introduction This section describes how to connect the HDPQ Xplorer to make basic single phase voltage measurements. For multi-phase connection diagrams, refer to Appendix E.

In this chapter The following topics are covered in this chapter.

Topic	See Page
Connecting Voltage Measurement Cables	2-4
Connecting Current Probes	2-10

WARNING Death, serious injury, or fire hazard could result from improper connection of this instrument. Read and understand this manual before connecting this instrument. Follow all installation and operating instructions while using this instrument.

Connection of this instrument must be performed in compliance with the National Electrical Code (ANSI/NFPA 70-2014) and any additional safety requirements applicable to your installation.

Installation, operation, and maintenance of this instrument must be performed by qualified personnel only. The National Electrical Code defines a qualified person as one who has the skills and knowledge related to the construction and operation of the electrical equipment and installations, and who has received safety training on the hazards involved.

Qualified personnel who work on or near exposed energized electrical conductors must follow applicable safety related work practices and procedures including appropriate personal protective equipment in compliance with the Standard for Electrical Safety Requirements for Employee Workplaces (ANSI/NFPA 70E-2012) of USA and any additional workplace safety requirements applicable to your installation.

Continued on next page

ADVERTENCIA Una conexión incorrecta de este instrumento puede producir la muerte, lesiones graves y riesgo de incendio. Lea y entienda este manual antes de conectar. Observe todas las instrucciones de instalación y operación durante el uso de este instrumento.

La conexión de este instrumento debe ser hecha de acuerdo con las normas del Código Eléctrico Nacional (ANSI/NFPA 70-2014) de EE. UU., además de cualquier otra norma de seguridad correspondiente a su establecimiento.

La instalación, operación y mantenimiento de este instrumento debe ser realizada por personal calificado solamente. El Código Eléctrico Nacional define a una persona calificada como "una que esté familiarizada con la construcción y operación del equipo y con los riesgos involucrados."

El personal cualificado que trabaja encendido o acerca a los conductores eléctricos energizados expuestos debe seguir prácticas y procedimientos relacionados seguridad aplicable del trabajo incluyendo el equipo protector personal apropiado en conformidad con el estándar para los requisitos de seguridad eléctricos para los lugares de trabajo del empleado (ANSI/NFPA 70E-2012) de los E.E.U.U. y cualquier requisito de seguridad adicional del lugar de trabajo aplicable a su instalación.

AVERTISSEMENT Si l'instrument est mal connecté, la mort, des blessures graves, ou un danger d'incendie peuvent s'en suivre. Lisez attentivement ce manuel avant de connecter l'instrument. Lorsque vous utilisez l'instrument, suivez toutes les instructions d'installation et de service.

Cet instrument doit être connecté conformément au National Electrical Code (ANSI/NFPA 70-2014) des Etats-Unis et à toutes les exigences de sécurité applicables à votre installation.

Cet instrument doit être installé, utilisé et entretenu uniquement par un personnel qualifié. Selon le National Electrical Code, une personne est qualifiée si "elle connaît bien la construction et l'utilisation de l'équipement, ainsi que les dangers que cela implique".

Le personnel qualifié qui travaillent dessus ou s'approchent des conducteurs électriques activés exposés doit suivre des pratiques en matière et des procédures reliées par sûreté applicable de travail comprenant le matériel de protection personnel approprié conformément à la norme pour des conditions de sûreté électriques pour les lieux de travail des employés (ANSI/NFPA 70E-2012) des Etats-Unis et toutes les conditions de sûreté additionnelles de lieu de travail applicables à votre installation.

WARNUNG

Der falsche Anschluß dieses Gerätes kann Tod, schwere Verletzungen oder Feuer verursachen. Bevor Sie dieses Instrument anschließen, müssen Sie die Anleitung lesen und verstanden haben. Bei der Verwendung dieses Instruments müssen alle Installation- und Betriebsanweisungen beachtet werden.

Der Anschluß dieses Instruments muß in Übereinstimmung mit den nationalen Bestimmungen für Elektrizität (ANSI/NFPA 70-2014) der Vereinigten Staaten, sowie allen weiteren, in Ihrem Fall anwendbaren Sicherheitsbestimmungen, vorgenommen werden.

Installation, Betrieb und Wartung dieses Instruments dürfen nur von Fachpersonal durchgeführt werden. In dem nationalen Bestimmungen für Elektrizität wird ein Fachmann als eine Person bezeichnet, welche "mit der Bauweise und dem Betrieb des Gerätes sowie den dazugehörigen Gefahren vertraut ist."

Qualifiziertes Personal, das an bearbeiten oder herausgestellte angezogene elektrische Leiter sich nähern, muß anwendbare Sicherheit bezogener Arbeit Praxis und Verfahren einschließlich passende persönliche schützende Ausrüstung gemäß dem Standard für elektrische Sicherheitsauflagen für Angestellt-Arbeitsplätze (ANSI/NFPA 70E-2012) der Vereinigten Staaten und alle zusätzlichen Arbeitsplatzsicherheitsauflagen folgen, die auf Ihre Installation anwendbar sind.

Safety precautions

The following safety precautions must be followed whenever any type of voltage or current connection is being made to the HDPQ Xplorer.

- Review NFPA70-E Standard for Electrical Safety Requirements for Employee Workplaces for applicable safety requirements for potential electrical hazards that may be encountered.
- Wear proper Personal Protective Equipment, including safety glasses and insulated gloves when making connections to power circuits.
- Hands, shoes and floor must be dry when making any connection to a power line.
- Before each use, inspect all cables for breaks or cracks in the insulation. Replace immediately if defective.
- Press the HDPQ Xplorer On/Off power switch to Off.
- Before connecting to electric circuits to be monitored, open their related circuit breakers or disconnects. DO NOT install any connection of the HDPQ Xplorer to live power lines.
- Connections must be made to the HDPQ Xplorer first, then connect to the circuit to be monitored.
- If the equipment is used in a manner not specified in this User Guide, the protection provided by the equipment may be impaired.

Continued on next page

Connecting Voltage Measurement Cables

Measurement cable set

Description: Voltage measurement cables are provided as standard accessories and are stored in a cable pouch as part of the measurement cable set, P/N VSC-HDPQ. Each cable set consists of a cable and alligator clip.

Voltage Rating: Direct connection of all voltage measurement cables are rated at 1000 VCAT III Vrms max. For measuring voltages greater than 1000 Vrms, potential transformers (PTs) must be used.

Contents: Example photo of HDPQ Xplorer with voltage measurement cable and optional fused voltage adapter is shown on page 2-6. A cable set consists of eight, 6-foot channel measurement cable assemblies (probes), each with a detachable, alligator jaw, safety clip assembly (maximum jaw opening, 3/4 in (20 mm)). There are four (4) black and four (4) white safety clips. While there are eight (8) black cables with different color wire markers to identify which phase or circuit wire each is connected to.

A pouch for storage of the cables and the AC adapter/battery charger is included in the contents of the measurement cable set, but is not shown in the figure.

Optional fused voltage adapter

There are two optional fuse voltage adapter accessory kits available for use with the measurement cables for the HDPQ Xplorer. A single kit (P/N FVA-1K1) contains one (1) fuse voltage adapter and one (1) black measurement connecting cable 50 cm in length. The other kit (P/N FVA-1K4) contains four (4) fuse voltage adapters and four (4) black measurement connecting cables 50 cm in length. These fuse voltage adapters are rated up to 1000V AC/DC applications.

A wire marker kit consisting of snap-on wire markers in various colors are also supplied with each fuse voltage adapter to be used for identifying connections applicable to your installation.

The single fuse voltage adapter kit is used for one single voltage measurement input. While the four fuse voltage adapter kit is used for a three phase and neutral voltage measurement inputs.

Wire markers

Each kit consisting of snap-on wire markers in various colors is supplied as described in the following table. These wire markers are to be used to identify each wire connection applicable to your installation.

Continued on next page

**Wire markers
(continued)**

- WMV-KIT (118376-G1) wire marker kit is included with the standard measurement cable set and is used for identifying voltage cables.
- WMI-KIT (118377-G1) wire marker kit is included with the standard measurement cable set and is used for identifying current probes.
- WMFV-KIT (118376-G2) wire marker kit is supplied with each Fuse Voltage Adapter and is used for identifying voltage cables.

Wire Marker Color	WMV-KIT Quantity (0.138 inch diameter)	WMI-KIT Quantity (0.218 inch diameter)	WMFV-KIT Quantity (0.138 inch diameter)
Blue	16	4	4
Black	4	4	4
Brown	4	4	4
Orange	4	4	4
Yellow	4	4	4
Red	4	4	4
Green	4	4	4
White	16	4	4

Measurement cable with optional fuse voltage adapter



WARNING To avoid the risk of electric shock or burns, always connect the safety (or earth) ground before making any other connections.

WARNING To reduce the risk of fire, electrical shock, or physical injury it is strongly recommended to fuse the voltage measurement inputs. Fuses must be located as close to circuit connection as possible to maximize protection.

WARNING For continued protection against risk of fire or shock hazard replace only with same type and rating of fuse.

WARNING Do not replace fuse again if failure is repeated. Repeated failure indicates a defective condition that will not clear with replacement of the fuse. Refer condition to a qualified technician.

Contact Dranetz Customer Service for more information on the fused voltage adapter. Refer to Dranetz Information Sheet titled Fuse Voltage Adapter 1000V AC/DC FVA-1K1 & FVA-1K4, P/N 899220.

Connection guidelines

Follow these guidelines when making voltage connections.

- Refer to the measurement cable set figure for probes that connect to input channel connectors A, B, C, and D.
- Each channel input has plus (+) and minus (-) differential inputs of 1 to 1000 Vrms max.

Example: Single phase connection

The following figure shows a voltage connection to a single phase circuit for channel A.

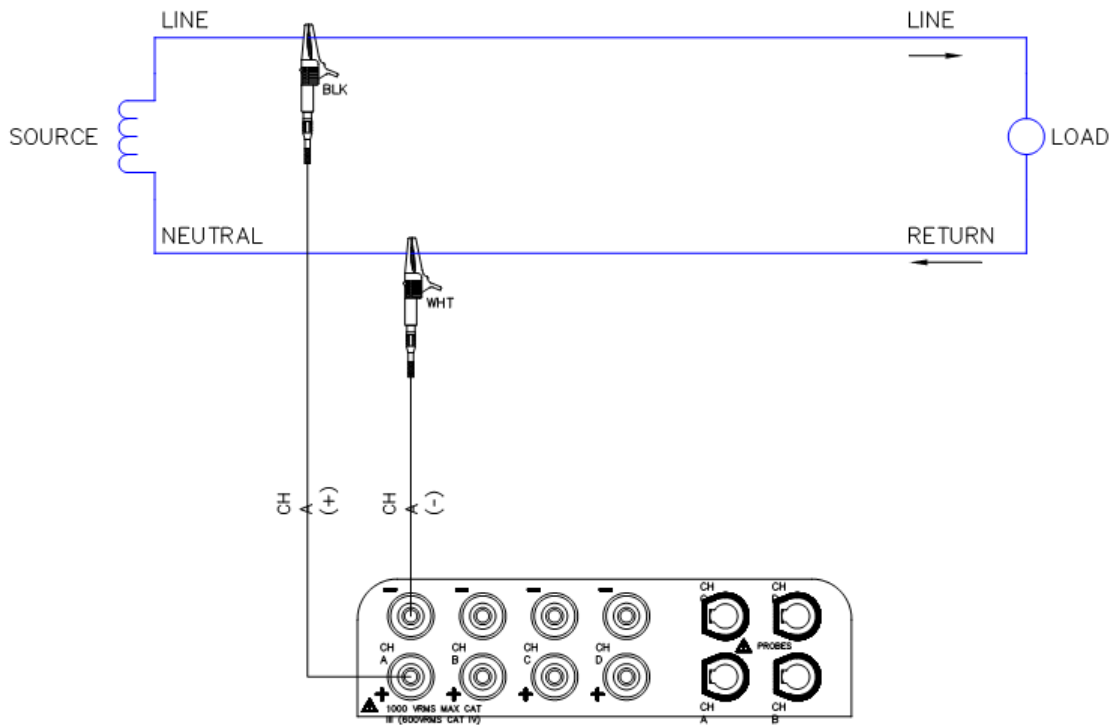

HDPQ-901a

Continued on next page

**Example:
Neutral to
ground
connection**

The following figure shows a voltage connection using channel D as a differential input for measuring neutral to ground voltage or other applications. Connections are identical for split phase and wye configurations. One probe connects the source neutral line to the D+ input. Another probe connects the ground to the D- input.

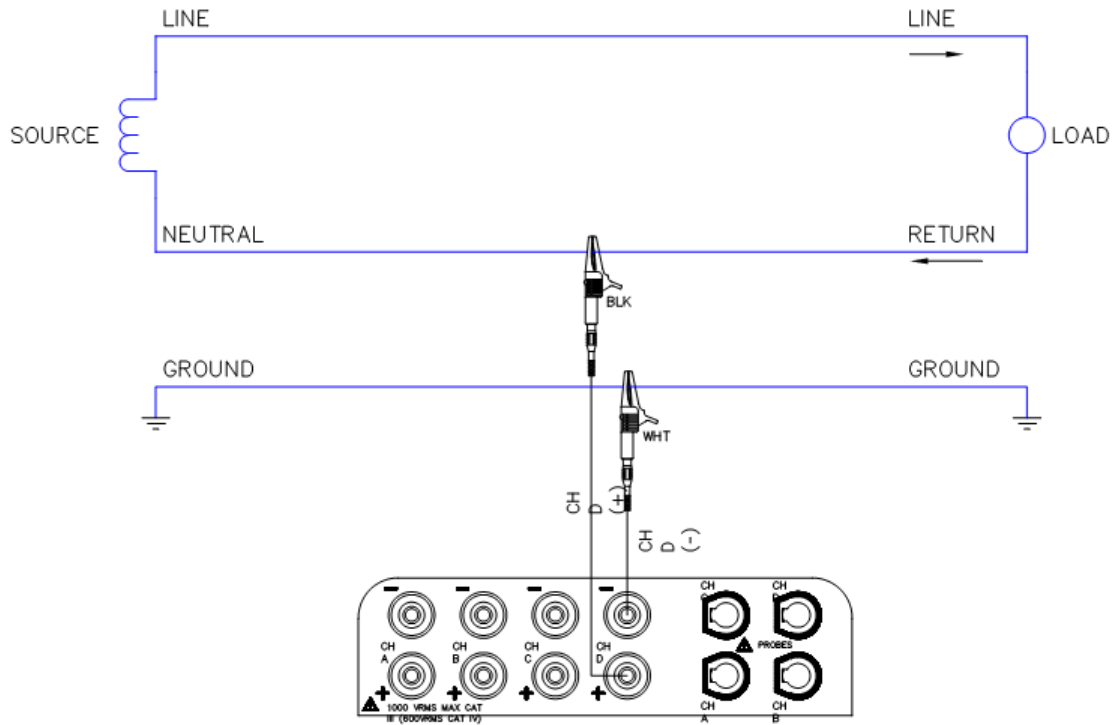

HDPQ-901c

Safety precautions

The following safety precautions apply to current probe connections in addition to those safety precautions stated on page 2-3.

- DO NOT attempt to measure current in any circuit in which the circuit to ground voltage exceeds the insulation rating of the current probe (see Appendix B Technical Specifications - Current Probes for ratings of current probes).
 - Make sure the jaws of the current probe are tightly closed. Keep mating surfaces clean and free from foreign matter.
-

WARNING

DO NOT USE non-insulated current probe cores around a non-insulated wire. Probes of this type are designed for use around insulated wires only. Use only completely insulated probe cores with no exposed conductive areas of the core around non-insulated wires.

ADVERTENCIA

NO UTILIZAR transformadores de corriente sin material aislante al rededor de conductores sin material aislante. Los Transformadores de corriente de este tipo estñn diseados para ser utilizados solamente con conductores con aislamiento elctrico. Utilizar transformadores de corriente completamente aislados alrededor de conductores sin aislamiento.

AVERTISSEMENT

N'EMPLOYEZ PAS les noyaux courants non-isolŽs de sonde autour d'un fil non-isolŽ. Des sondes de ce type sont concues pour l'usage autour des fils isolŽs seulement. L'utilisation seulement a complŽtement isolŽ des noyaux de sonde sans des secteurs conducteurs exposŽs du noyau autour des fils non-isolŽs.

WARNUNG

VERWENDEN Sie keine Stromzangen mit nicht isolierten Ferritkernen bei Messungen an nicht isolierten Leitungen. Stromzangen dieses Typs sind nur fŸr Messungen an isolierten Leitern geeignet. Bitte verwenden Sie zur Messung an nicht isolierten Leitungen Stromzangen mit vollstŠndig isoliertem Kernmaterial.

Connecting Current Probes

Current probes Several Dranetz current probes can be used with the HDPQ Xplorer. Actual photos of typical probes compatible with the HDPQ Xplorer - TR (B Series) probes, PR (B Series) probes, DRANFLEX (XLB and MHB Series) - are illustrated in the next pages, with corresponding part numbers and descriptions. Refer to Appendix B Technical Specifications for detailed specifications of these current probes.





NOTE: Some older probes may be incompatible with the HDPQ Xplorer. Refer to Appendix A Optional Accessories for the list of compatible probes before connecting any.

Probe positioning: An arrow marking on the handle is a guide to ensure that you position the probe with the arrow pointing towards the load when monitoring the line conductor. Correct position of the probe is necessary for correct power measurements, where in-phase voltage and current measurements are necessary. A positive watts reading indicates that the probe is pointed towards the load, and a negative reading indicates that the probe is pointed towards the source.

Continued on next page

**TR (B Series)
current probes**

Actual photos of TR (B Series) probes and descriptions are shown below as aid in probe identification. Note all the typical probes described below and in the next pages have Hypertronics connectors that plug directly into the current inputs of the HDPQ Xplorer without any cable adapter. Contact Dranetz Customer Service Department for information on pricing and availability.

TR (B Series) Probe Description	
	Model No. : TR-2500B Current Range : 10A to 500A RMS Dranetz Part No. : 118284-G1 Installation Category : 600V, CAT III
	Model No. : TR-2501B Current Range : 100mA to 1.2A RMS Dranetz Part No. : 118283-G1 Installation Category : 600V, CAT III
	Model No. : TR-2510B Current Range : 1A to 10A RMS Dranetz Part No. : 118285-G1 Installation Category : 600V, CAT III
	Model No. : TR-2550B Current Range : 1A to 100A RMS Dranetz Part No. : 118289-G1 Installation Category : 600V, CAT III
	Model No. : TR-2530B Current Range : 20A to 300A RMS Dranetz Part No. : 118287-G1 Installation Category : 600V, CAT III
	Model No. : TR-2540B Current Range : 10A to 1000A RMS Dranetz Part No. : 118288-G1 Installation Category : 600V, CAT III
	Model No. : TR-2520B Current Range : 100A to 3000A RMS Dranetz Part No. : 118286-G1 Installation Category : 600V, CAT III

PR (B Series) current probes

Actual photo of PR (B Series) probe is shown below as aid in probe identification. PR150/SP1B and PR1500/SP7B require an external power supply while PR150/SP2B and PR1500/SP8B are battery powered. Contact Dranetz Customer Service Department for information on pricing and availability.

PR (B Series) Probe Description	
	Model No. : PR150/SP1B (requires 9V adapter) Current Range : 15A to 150A AC/DC Dranetz Part No. : 118290-G1 Installation Category : 600V, CAT III
	Model No. : PR150/SP2B (9V battery powered) Current Range : 15A to 150A AC/DC Dranetz Part No. : 118291-G1 Installation Category : 600V, CAT III
	Model No. : PR1500/SP7B (requires 9V adapter) Current Range : 150A to 1500A AC/DC Dranetz Part No. : 118292-G1 Installation Category : 600V, CAT III
	Model No. : PR1500/SP8B (9V battery powered) Current Range : 150A to 1500A AC/DC Dranetz Part No. : 118293-G1 Installation Category : 600V, CAT III

External power supply for PR150/SP1B & PR1500/SP7B

The PR150/SP1B and PR1500/SP7B current probes require an external 9V power supply, actual photo shown below. Each probe can be powered by a separate adapter or by one adapter and an optional RR/PS/4A adapter cable which allows the connection of 4 PR series probes to a single 9VDC source.

9VDC Adapter Description	
	Model No. : PR9VUA Dranetz Part No. : 118073-G1 Input Voltage : 100-240 VAC, 50/60 Hz Input Plug Type : US, Euro, UK, Australia Output : +9VDC, 1.11A

Battery supply for PR150/SP2B & PR1500/SP8B

The PR150/SP2B and PR1500/SP8B current probes are supplied with a 9V battery and will operate on battery power typically for approximately 75 hours of continuous operation.

Reference material

Refer to Dranetz User Instructions titled PR150/SP1, PR150/SP2, PR1500/SP7, PR1500/SP8 AC/DC Current Probes, P/N 899216.

**DRANFLEX
XLB & MHB
current probes**

Actual photos of DRANFLEX XLB and MHB Series probes are shown below as aid in probe identification. These probes are available in different sizes, allowing current measurements in Single Phase or 3 Phase circuits. Contact Dranetz Customer Service Department for information on pricing and availability.

DRANFLEX Probe Description	
<p>Single Phase Probe</p> 	<p>Model No. : DRANFLEX3000XLB Current Range : 30/300/3000A Dranetz Part No. : 118433-G1 (24 inches) : 118434-G1 (36 inches) : 118435-G1 (48 inches) Installation Category : 1000V, CAT III : (600V, CAT IV)</p>
	<p>Model No. : DRANFLEX6000XLB Current Range : 60/600/6000A Dranetz Part No. : 118439-G1 (24 inches) : 118440-G1 (36 inches) : 118441-G1 (48 inches) Installation Category : 1000V, CAT III : (600V, CAT IV)</p>
<p>3 Phase Probe</p> 	<p>Model No. : DRANFLEX3003XLB Current Range : 30/300/3000A Dranetz Part No. : 118436-G1 (24 inches) : 118437-G1 (36 inches) : 118438-G1 (48 inches) Installation Category : 1000V, CAT III : (600V, CAT IV)</p>
	<p>Model No. : DRANFLEX6003XLB Current Range : 60/600/6000A Dranetz Part No. : 118442-G1 (24 inches) : 118443-G1 (36 inches) : 118444-G1 (48 inches) Installation Category : 1000V, CAT III : (600V, CAT IV)</p>
<p>Single Phase Probe</p> 	<p>Model No. : DRANFLEX300MHB Current Range : 3/30/300A Dranetz Part No. : 118430-G1 (6 inches) : 118431-G1 (8 inches) : 118432-G1 (12 inches) Installation Category : 1000V, CAT III : (600V, CAT IV)</p>

Optional power supply for DRANFLEX probes

If you are using DRANFLEX Series XL or MH (non-B) probes, an external power supply is recommended for continuous operation. These probes can be operated on battery power with two standard type "AA" batteries which provide 2000 life hours for the XL and 80 life hours for the MH type probes.

NOTE: DRANFLEX Series XLB and MHB type probes are powered by the HDPQ Xplorer instrument and do not require an external power supply.

The two models of optional power supply available for DRANFLEX current probes are the ISOFLEX-MHXL and ISOFLEX-MHXLU.

ISOFLEX-MHXL

	Description
	<p>ISOFLEX-MHXL has a 12VDC input that is powered from the AC adapter supplied as a standard accessory for HDPQ Xplorer, HDPQ Guide or HDPQ Visa. This power supply provides a pass through 12VDC output for connection to power the instrument and a 3VDC isolated output to power flex type current probes only.</p>

ISOFLEX-MHXLU

	Description
	<p>ISOFLEX-MHXLU is supplied with an attached wall plug power supply and is supplied with interchangeable input plugs for North America, Europe, UK and Australia. The output of this accessory provides a 3VDC output to power flex type current probes only.</p>

**Single phase
current probe
connection
example**

The following figure shows how to connect a current probe to channel A for current monitoring of a single phase line.

The current probe may be connected to the return line if desired to measure the return current when checking for load current leakage, loop current relationships, etc. If measuring power, position the probe with the arrow pointing towards the load.

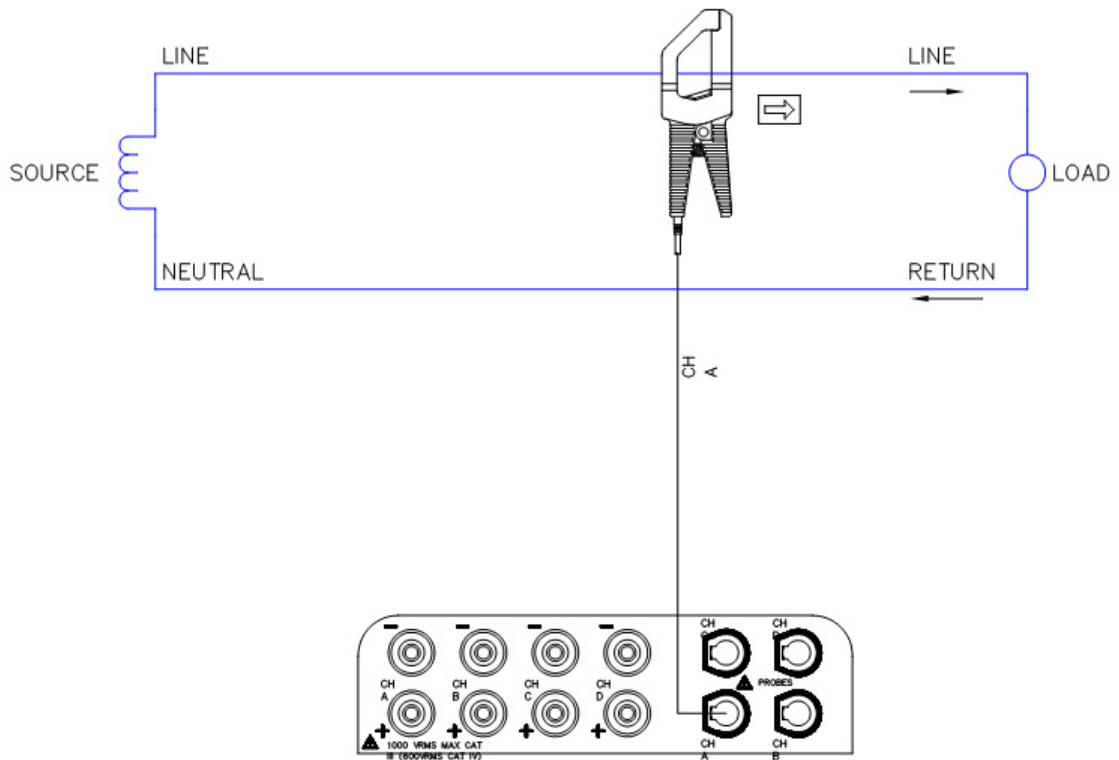

HDPQ-901b

NOTE: The connection shown above is not recommended without a voltage connection to ensure frequency synchronization. If this configuration is used, then an internal frequency reference must be entered. Refer to Chapter 4 Setup Monitoring - Nominal Values.

This page intentionally left blank.

CHAPTER 3



Real Time Data

Overview

Introduction

HDPQ Xplorer allows you to view power quality phenomena as it happens, when it happens. The instrument is able to capture and process data in real time, and allows you to view it in Dial Meters (graphical), Tabular Meters (textual), Scope Mode, Dashboard, Harmonics and Phasor display.

Access to real time data

Follow these steps to display the Real-Time Data menu.

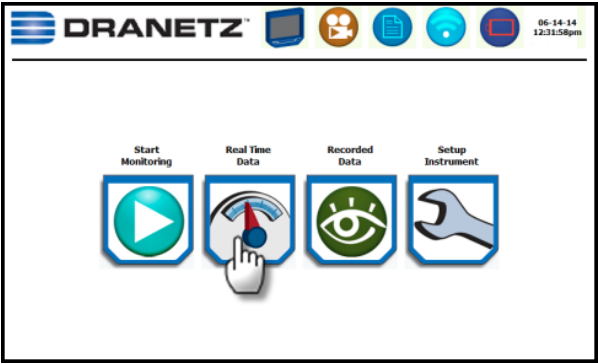
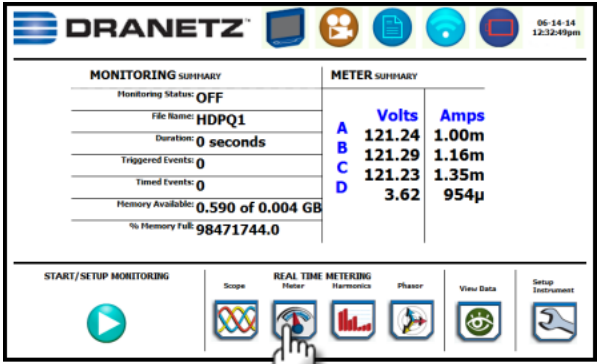
Action...	Result...
<p>STEP 1: There are three (3) ways to access the Real-Time Data icon:</p> <p>1st: Upon instrument power-up and prior to monitoring, the Home page displays shortcut buttons, one of which is Real-Time Data. Proceed to Step 2.</p>	 <p style="text-align: right;">HDPQ-110a</p>
<p>2nd: If monitoring is on, the Home Monitoring page becomes the start-up page.</p> <p>Real Time Metering icons on the work area provide direct access to the real-time meters i.e. Scope, Meter, Harmonics and Phasor. Each of these functions is discussed in its own section.</p>	 <p style="text-align: right;">HDPQ-111b</p>

Continued on next page

Access to real time data (continued)

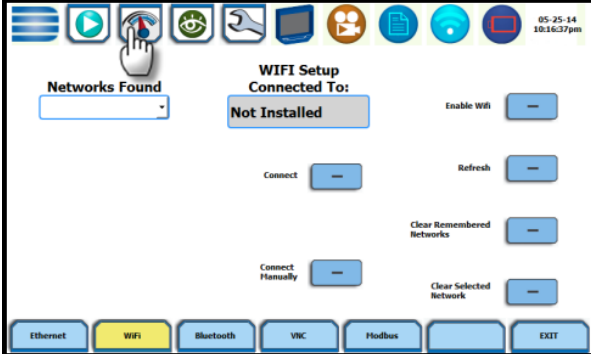
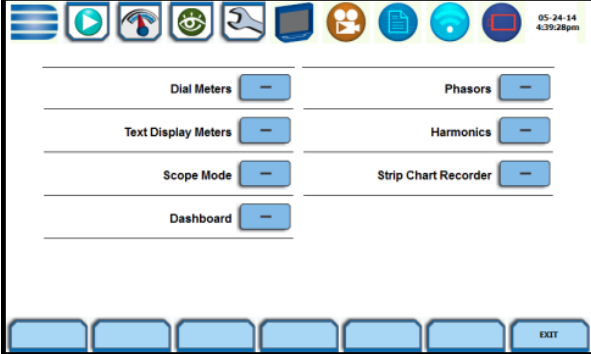
Action...	Result...
<p>3rd: Real-Time Data icon is also accessible on the taskbar of most typical screens, where shortcuts to common instrument functions are found.</p> <p>Example: You can access Real-Time Data from the taskbar of the Communications setup screen.</p>	 <p style="text-align: right;">HDPQ-302</p>
<p>STEP 2: The Real-Time Data menu contains selections for Dial Meters, Text Display Meters, Scope Mode, Dashboard, Phasors, Harmonics and Strip Chart Recorder. Refer to the particular section for information on each function.</p>	 <p style="text-align: right;">HDPQ-303</p>

In this chapter This chapter is divided into the following sections.

Section	Title	See Page
A	Dial Meters	3-3
B	Text Display Meters	3-5
C	Scope Mode	3-15
D	Dashboard	3-19
E	Voltage and Current Phasor	3-30
F	Harmonics	3-35
G	Strip Chart Recorder	3-43

Section A

Dial Meters

Overview

Introduction Dial Meters allow you to define the parameters and create dial-type readings of each channel or parameter. The readings are updated at approximately once every three seconds.

Dial meters The Dial Meters screen can be displayed by pressing **Dial Meters** from the Real-Time Data menu. Six dial type meters can be displayed for any of the channel/parameters that are journalled. By default, the instrument shows dial-type readings for the voltage (V) and current (I) parameters - Va, Vb, Vc, Ia, Ib, Ic. Axis (end points of meter) can be changed on per meter basis and journal limits can be shown as bands of colors on the dial face.

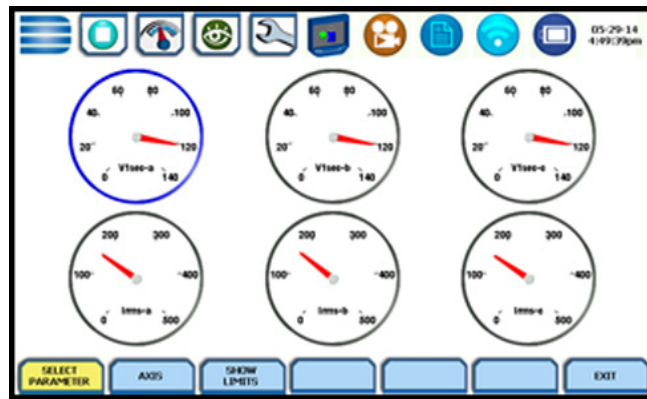

HDPQ-304

Function keys Use the function keys at the bottom of the screen to set up the dial meters.

Select Parameter - allows you to change and select parameters/channels to trend and display journalled data in dial meters. If you press this, the Change Parameter/Channel

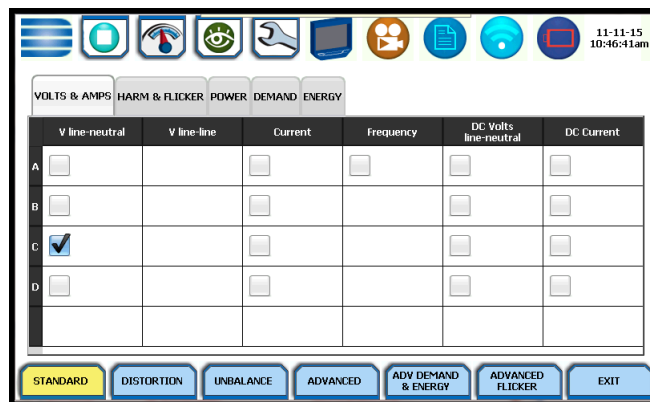

HDPQ-305

Continued on next page

**Function keys
(continued)**

window for metered parameters pops up showing groupings and arrangements of parameter/channel combinations. Check your desired parameter/channel, then click on Exit to view the selections made. Refer to Section B Text Display Meters for the list of parameters available for display.

Axis - allows you to change the minimum and maximum values or range of values for each dial meter on display. If you press this, the numeric keypad pops up where you can enter new minimum and maximum values for end points of the meter axis.

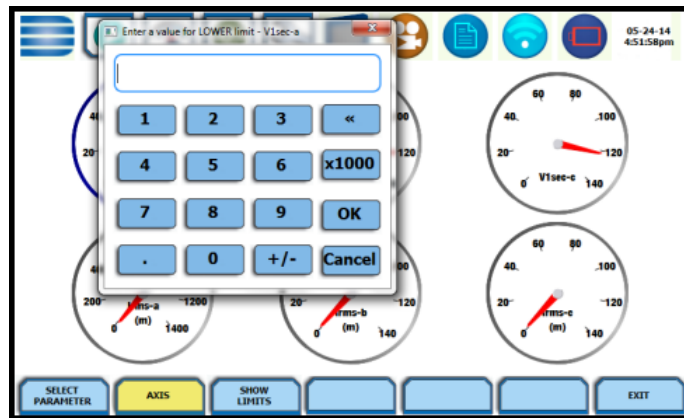

HDPQ-306

Use the numeric keypad to:

- enter new minimum values for end points of the meter axis
- enter new maximum values for end points of the meter axis
- set the dial meter scale to the fundamental at 100% (full scale) or the largest component
- Press **OK** to save any changes made and return to the dial meter screen with new min-max values as displayed.
- Press **Cancel** to return to the dial meters screen without changing any of the displayed min-max values.

Show Limits - allows you to change the display of the dial meter to show the journal limits. If threshold limits are programmed (Very Low limit, Low limit, High limit, Very High limit) to trigger events, they can be displayed as colored regions on the dial meter circular axis. Each color - red, yellow or green - corresponds to threshold limits set in ranges with high limit (threshold above the normal range) and low limit (threshold below the normal range). The table below shows the dial meter axis color codes.

Color region display	Threshold limit range
Red	Min or 0 to Very Low, Very High to Max
Yellow	Very Low to Low, High to Very High
Green	Low to High

The **Exit** key returns to the Real Time Data menu.

Section B

Text Display Meters

Overview

Introduction Meter mode is enabled by pressing **Text Display Meters** from the Real-Time Data menu or by pressing the real-time Meter icon on the work area of the Home Monitoring page. Text display meter screens are displayed in tabular form.

NOTE: Meter mode operation does not interfere with any of HDPQ Xplorer’s other monitoring or recording functions. The individual voltage and current channel meter readings are not affected by the monitoring setup. Turning monitoring of individual channels off does not affect meter readings.

Metered parameters display The metered parameters available are logically separated into the following tabs: Standard, Distortion, Unbalance, Advanced Power, Advanced Demand & Energy and Advanced Flicker. The function keys at the bottom of the meter screens change depending on the parameter tab selected. Text display meter changes to reflect the specified set of parameter/channel combination selected. The format of text meter screens is similar for all, although the amount of data varies. The Exit key returns to the Real Time Data menu.

HDPQ Xplorer is designed to provide setup as well as data display. Metered parameters are available for display regardless if they are being journalled under Start Menu > Wizard Setup > Trigger Limits > Journal Limits.

In this section The following topics are covered in this section.

Topic	See Page
Standard Meter Tab	3-6
Distortion Meter Tab	3-8
Unbalance Meter Tab	3-9
Advanced Meter Tab	3-10
Advanced Demand & Energy Meter Tab	3-11
Advanced Flicker Meter Tab	3-14

Standard Meter Tab

Standard meter list At start-up, text display meter defaults in the Standard tab featuring the basic power quality parameters available as shown below.

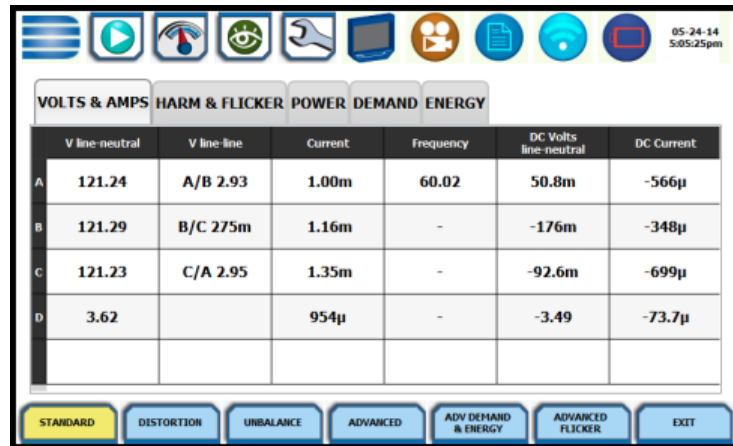

HDPQ-307

Standard Tab	Parameter Name	Label
Fx: Volts & Amps	Voltage (L-N)	$V_{\text{line-neutral}}$
	Voltage (L-L)	$V_{\text{line-line}}$
	Current	Current
	Frequency	Frequency
	DC Volts (L-N)	DC Volts $_{\text{line-neutral}}$
	DC Current	DC Current
Fx: Harm & Flicker	Voltage THD	Voltage THD
	Current THD	Current THD
	Short Term Flicker	Pst
	Long Term Flicker	Plt
	Long Term Flicker (Sliding)	Plt sliding

Continued on next page

Standard meter list (continued)

Standard Tab	Parameter Name	Label
Fx: Power	Active Power	Active Power
	Apparent Power	Apparent Power
	Fundamental Reactive Power	Fundamental Reactive Power
	True Power Factor	True Power Factor
	Displacement Power Factor	Displacement Power Factor
Fx: Demand	Current Demand	Demand Current
	Active Power Demand	Demand Watts
	Apparent Power Demand	Demand VA
	Volts Ampere Reactive Demand	Demand var
Fx: Energy	Watt Hours	Watt-h
	Volts Ampere Hours	VA-h
	Volts Ampere Reactive Hours	VAR-h

NOTE: See Appendix B Technical Specifications - Computed Parameters for definition of parameters.

Distortion Meter Tab

Distortion meter list HDPQ Xplorer is able to meter distortions or uncharacteristic changes in the waveform of original signals. Distortion calculations measure the deviation of complex waveshapes from pure sine waves. Harmonics are measured in accordance with IEC 61000-4-7 Class I.

	V Crest Factor	I Crest Factor	Transformer Derating	Transformer K Factor	Current TDD
A	1.40	5.54	49.0m	842.71	9.58μ
B	1.42	6.32	49.0m	842.40	12.8μ
C	1.43	5.76	49.1m	839.45	13.3μ
D	1.46	6.76	49.2m	835.80	11.2μ

HDPQ-308

Distortion Tab	Parameter Name	Label
Fx: Distortion	Voltage Crest Factor	V Crest Factor
	Current Crest Factor	I Crest Factor
	ANSI Transformer Derating Factor	Transformer Derating
	Transformer K Factor	Transformer K factor
	Total Demand Distortion	Current TDD

Unbalance Meter Tab

Unbalance meter list

The Unbalance metering tab shows positive, negative and zero sequence components for voltage and current, as well as the NEMA definition of maximum deviation from the average of the three phases.

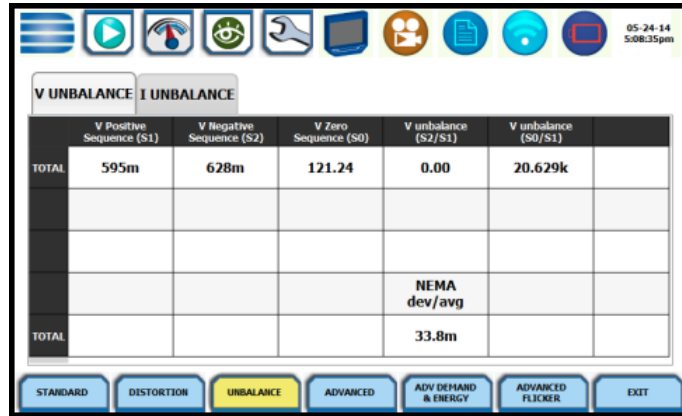

HDPQ-309

Unbalance Tab	Parameter Name	Label
Fx: V Unbalance	Positive Sequence Voltage	V Positive Sequence (S1)
	Negative Sequence Voltage	V Negative Sequence (S2)
	Zero Sequence Voltage	V Zero Sequence (S0)
	V Unbalance (S2/S1)	V unbalance (S2/S1)
	V Unbalance (S0/S1)	V unbalance (S0/S1)
Fx: I Unbalance	Positive Sequence Current	I Positive Sequence (S1)
	Negative Sequence Current	I Negative Sequence (S2)
	Zero Sequence Current	I Zero Sequence (S0)
	I Unbalance (S2/S1)	I unbalance (S2/S1)
	I Unbalance (S0/S1)	I unbalance (S0/S1)

Advanced Meter Tab

Advanced meter list The Advanced metering tab shows positive, negative and zero sequence components for voltage and current.

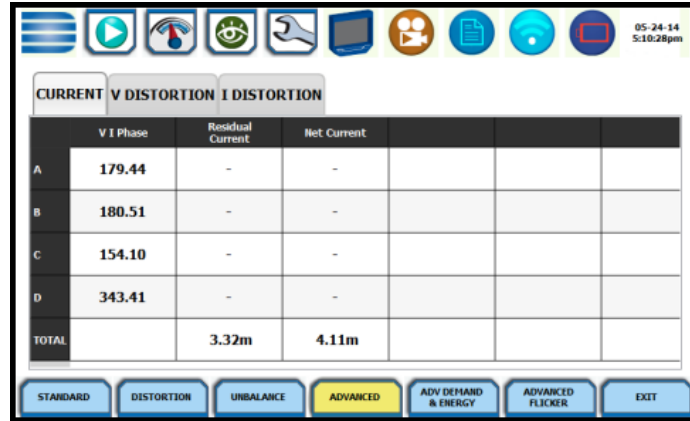

HDPQ-310

Advanced Meter Tab	Parameter Name	Label
Fx: Current	V/I Phase	V/I Phase
	Residual Current	Residual Current
	Net Current	Net Current
Fx: V Distortion	Voltage Total Harmonic Distortion	Vthd RSS
	Voltage Telephone Influence Factor	VTIF
	Voltage Total Interharmonic Distortion	VTID
	Unsigned Harmonic Power	Unsigned Harmonic W
Fx: I Distortion	Current Total Harmonic Distortion	Ithd RSS
	Current Total Interharmonic Distortion	ITID
	RMS Current Individual Odd Harmonics	I Odd Harmonic
	RMS Current Individual Even Harmonics	I Even Harmonic
	IT Product	IT Product

Advanced Demand & Energy Meter Tab

Advanced energy meter list

Advanced energy metering tab meters multiple total apparent power and power factor parameters, calculated using arithmetic and vector sums of the individual phases. These methods may produce different values with distorted and/or unbalance phases. Demand/Advanced Energy include various energy parameters on per phase and total basis as well as in forward and reverse mode. Some parameters such as displacement power factor are only valid for the fundamental frequency. The Advanced energy tab also allows trending of rapid voltage changes that result in light flicker. Flicker parameters under the Advanced energy tab are used primarily for specialized testing. Flicker measurements are calculated as per IEC 61000-4-15.

The screenshot shows a software interface with a top navigation bar containing icons for menu, play, gauge, eye, hand, monitor, camera, document, signal, and a red box. The date and time '05-24-14 5:13:54pm' are displayed in the top right. Below the icons are four tabs: 'FORWARD & REVERSE', 'PREDICTED/PEAK', 'PEAK @', and 'ARITH. & VECTOR'. The 'FORWARD & REVERSE' tab is active, displaying a table with the following data:

	Forward W-h	Reverse W-h	Forward Fundamental var-h	Reverse Fundamental var-h	VA-h
A	150μ	122μ	351μ	35.7μ	79.3m
B	603μ	22.8μ	675μ	17.3μ	91.2m
C	774μ	11.8μ	1.11m	2.35μ	106m
D	304μ	0.00	6.12n	1.23μ	2.18m
TOTAL	1.53m	156μ	2.14m	55.3μ	

At the bottom of the interface are seven buttons: 'STANDARD', 'DISTORTION', 'UNBALANCE', 'ADVANCED', 'ADV DEMAND & ENERGY' (highlighted in yellow), 'ADVANCED FLICKER', and 'EXIT'.

HDPQ-311

Advanced Energy Tab	Parameter Name	Label
Fx: Forward & Reverse	Forward Frequency W-Hrs	Forward W-h
	Reverse Frequency W-Hrs	Reverse W-h
	Fwd Fundamental Frequency var Hrs	Forward Fundamental var-h
	Reverse Fundamental Frequency var Hrs	Reverse Fundamental var-h
	Frequency VA Hrs	VA-h
Fx: Predicted/Peak	Predicted P Demand	Predicted P Demand
	Predicted Q Demand	Predicted Q Demand
	Predicted S Demand	Predicted S Demand

Continued on next page

Advanced energy meter list (continued)

Advanced Energy Tab	Parameter Name	Label
Fx: Predicted/Peak	Peak Active Power Demand	Peak W Demand
	Peak Apparent Power Demand	Peak VA Demand
	Peak Reactive Power Demand	Peak VAR Demand
	Peak Current Demand	Peak I Demand
Fx: Peak @	Avg PF @ Peak P Demand	Avg PF @ Peak P Demand
	S Demand @ Peak P Demand	S Demand @ Peak P Demand
	Q Demand @ Peak P Demand	Q Demand @ Peak P Demand
	Avg PF @ Peak Q Demand	Avg PF @ Peak Q Demand
	P Demand @ Peak Q Demand	P Demand @ Peak Q Demand
	S Demand @ Peak Q Demand	S Demand @ Peak Q Demand
	Avg PF @ Peak S Demand	Avg PF @ Peak S Demand
	P Demand @ Peak S Demand	P Demand @ Peak S Demand
	Q Demand @ Peak S Demand	Q Demand @ Peak S Demand

Continued on next page

**Advanced
energy meter list
(continued)**

Advanced Energy Tab	Parameter Name	Label
Ex: Arith & Vector	Arithmetic Sum Power Factor	Arithmetic Sum PF
	Arithmetic Sum Displacement Power Factor	Arithmetic Sum DPF
	Arithmetic Sum Volts Ampere	Arithmetic Sum VA
	Fundamental Arithmetic Sum Volts Ampere	Fundamental Arithmetic Sum VA
	Fundamental Vector Sum Volts Ampere	Fnd Vector Sum VA

Advanced Flicker Meter Tab

Advanced flicker list

The Advanced flicker parameters are used primarily for specialized testing. Flicker measurements are calculated as per IEC 61000-4-15 and IEEE 1453.

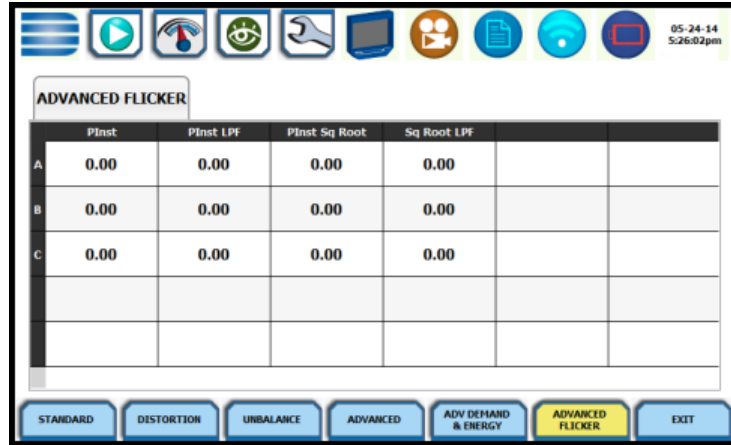

HDPQ-312

Advanced Flicker Tab	Parameter Name	Label
Ex: Advanced Flicker	Instantaneous Flicker	PInst
	PInst LPF	PInst LPF
	PInst Square Root	PInst Sq Root
	Square Root Low-Pass Filter	Sq Root LPF

Section C

Scope Mode

Overview

Introduction Scope mode allows you to view real-time voltage (V) and current (I) waveforms for up to eight channels simultaneously (four V and four I). Waveforms may be displayed on a single or dual axis (overlaid or stacked). A range check function shows the detected input range for all channels.

Scope mode screen The Scope mode screen can be displayed by pressing **Scope Mode** from the Real-Time Data menu or by pressing the Scope real-time metering icon on the work area of the Home Monitoring page.

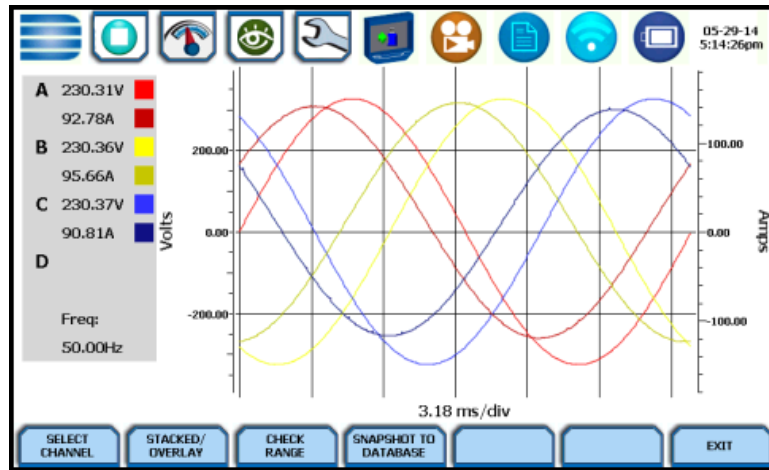

HDPQ-313

In this section The following topics are covered in this section.

Topic	See Page
Turning Channels On/Off	3-16
Viewing Plots - Stacked/Overlay	3-17
Checking Input Range	3-18

Turning Channels On/Off

Select channels to display

From Scope mode, press **Select Channel** to turn Volts/Amps channel selection on/off. The pop-up window lets you select which channels will appear in the Scope mode display.

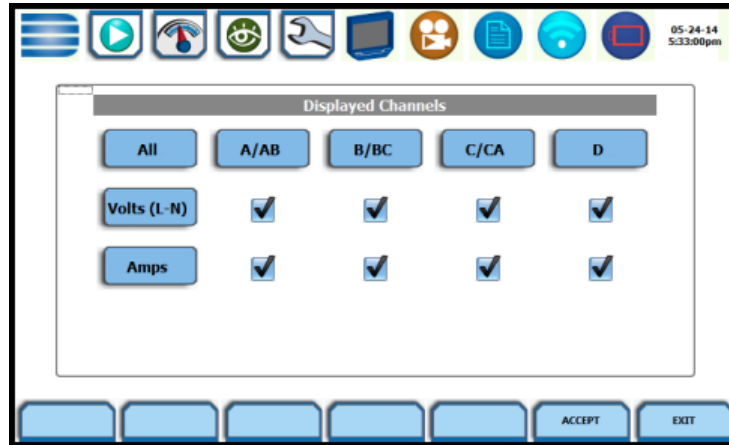

HDPQ-314

Doing any of the following actions will turn channels on/off:

- Press the desired **Volts/Amps** to turn it on/off.
- Press **Volts** or **Amps** to turn on/off all channels of that parameter.
- Press **All** to turn on/off both the Volts and Amps for all channels.
- Press **A/AB, B/BC, C/CA, D** to turn on/off both the Volts and Amps for that channel.

Press **Accept** to save any changes made and return to Scope mode. The channels will be as displayed in the check boxes.

Press **Exit** to return to Scope mode without changing any of the displayed channels.

Viewing Plots - Stacked/Overlay

Plot display

The **Stacked/Overlay** button from Scope mode toggles between single, multiple or dual axis plots and views, samples shown below. This function allows you to view all voltage and current channels either in:

Overlay Plot - single axis plot

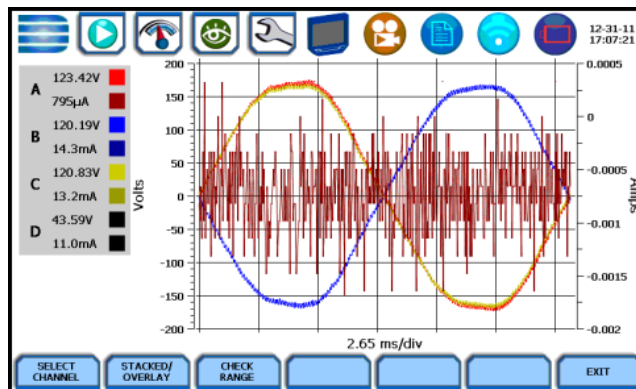

HDPQ-315a

Multiple Stacked Plot - separate, multiple plots with voltage and current pairs from same channel appearing on the same graph

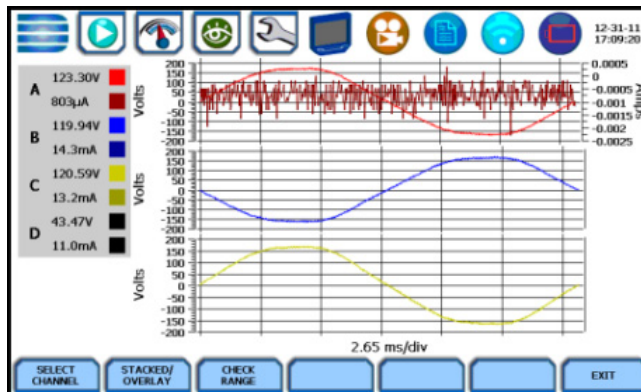

HDPQ-315b

Dual Stacked Plot - separate, two axis plots with one plot showing all voltage channels and one plot showing all current channels

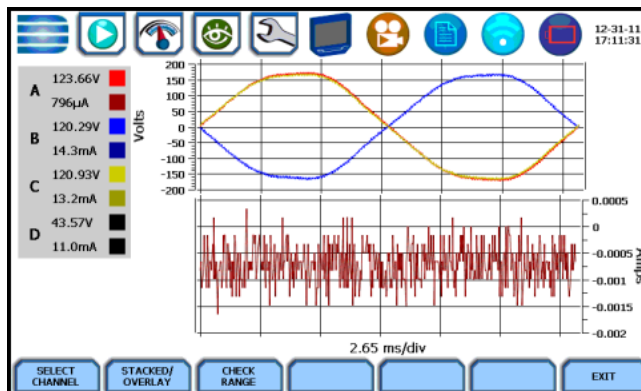

HDPQ-315c

Checking Input Range

Input range

From Scope mode, press **Check Range**. The input range window pops up showing the status of the voltage and current input channels, whether under range, normal, or over range. For Current, under range is reported below 0.4% of full scale and over range is reported above 200% of full scale. For Voltage, under range is reported below 1% of full scale and over range is reported above 99% of full scale.

Input Range shows the detected range for all channels. The number after the status shows the percentage of the input of the instrument's full range.

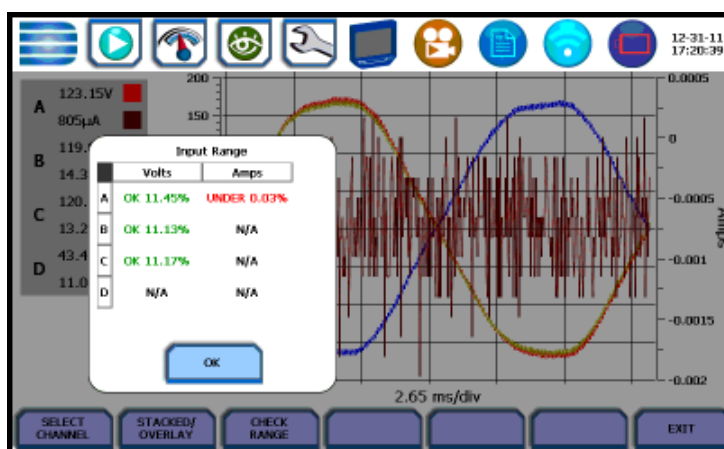

HDPQ-316

The input range can only be viewed, not changed. Press OK when done viewing the input range.

Input range description

The following table describes the messages that may register on the Input Range screen. The instrument is able to detect the input range for voltage and current channels A, B, C, and D.

Input Range	Description
OK	Within Range
OVER	Over Range
UNDER	Under Range
N/A	Channel Disabled
CLIP	Clipping

If input range is OVER, UNDER, or CLIP, then the rms readings will not be accurate. Using CTs below 10% of Full Scale may also cause inaccuracies in amplitude, phase and harmonic distortion readings.

Section D

Dashboard

Overview

Dashboard display

The Dashboard is a visual way of seeing present values as well as if any events occurred, such as out-of-limit conditions, for each of the displayed parameter. The dashboard displays meter data (or event count) in a 3x4 matrix. It is color coded to indicate whether or not the parameter is within limits.

Status summary for three report types - Power Quality (PQ), Energy/Demand and Motor Health - can be displayed via the dashboard display. Real time data, event count, or user specified calculated data is available in 3x4 matrix display.

When monitoring is on, the dashboard displays parameter status, whether parameter is within limits, using a color scheme. Journal data and events can be directly viewed from the dashboard.

From the Real-Time Data menu, press **Dashboard**. The dashboard will display standard Power Quality preset parameters by default, as shown on sample screens below. Each function category - Power Quality, Energy/Demand and Motor Health - is set with pre-defined channel/parameter values. Each category contains fixed template cell settings that cannot be modified; however the user is able to turn on/off alarm monitoring for each cell.

In the example below, selecting a cell under Power Quality brings up the screen containing pre-set template values for the PQ cell parameter.

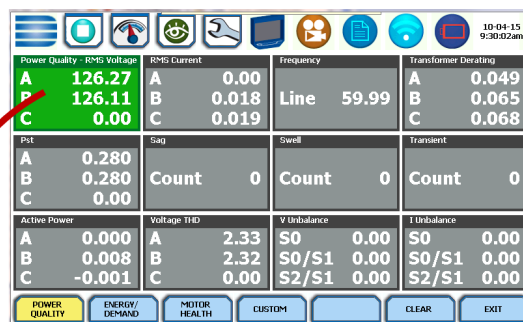

Pressing and selecting a cell will bring up three function keys - Setup Cell Alarm, Trend Plot and Event List - used to turn on/off alarm monitoring on cell parameters. Deselecting the cell will hide those keys from view. Selection will timeout and return to previous dashboard screen in about 10 seconds.

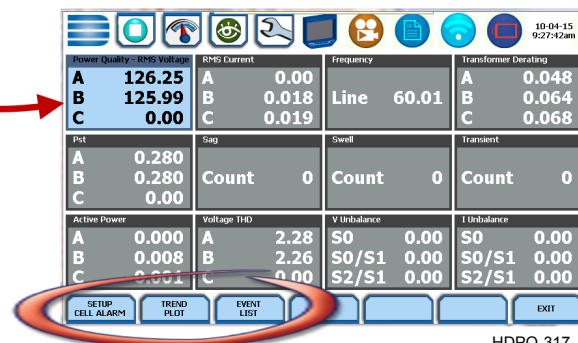

HDPQ-317

Dashboard display (continued)

NOTE: Where applicable, the values reported within a parameter in the dashboard refer to measurements on channels A, B, C, and D respectively. The measurement values for each channel are updated approximately once per second while monitoring is on.

Compliance: The dashboard is color coded such that green indicates the parameter is within limits and/or no events have occurred since the last time the panel was cleared. Red indicates the parameter is extremely out of limits and/or events of that type have occurred since the panel was last cleared.

Dashboard function keys

Function keys are available to view preset parameters or change parameters and channels displayed in the dashboard.

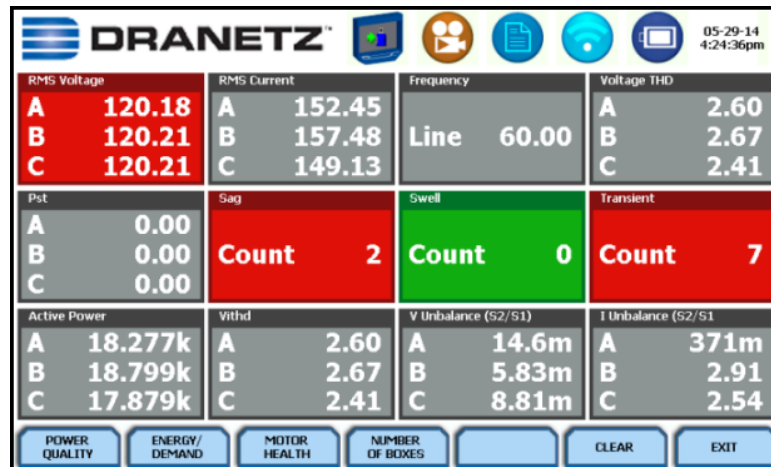

HDPQ-318

Presets provide a set of default parameters that will be displayed in the dashboard. Use the corresponding functions keys for the three different presets available:

Power Quality - uses the standard power quality parameters based on IEEE 1159 PQ standard. The dashboard displays standard Power Quality preset parameters by default. The default parameters for PQ as displayed in the 3x4 panel are (from first row left to right): Vrms, Irms, Freq, Vitd, Pst, Sag, Swell, Transient, Active Power, Vitd, V neg/ pos unbalance, I neg/pos unbalance. See next section Default Template Presets.

Energy/Demand - default parameters for Energy/Demand as displayed in the 3x4 panel are (from first row left to right): Energy, Demand, Predicted Demand, Vrms, Irms, W, VA, VAR, PF, Daily Peak Dmd, Weekly Peak Dmd, Monthly Peak Dmd. See next section Default Template Presets.

Continued on next page

**Dashboard
function keys
(continued)**

Motor Health - displays parameters that affect the operation of motors. The default parameters for Motor Health as displayed in the 3x4 (medium) panel are (from first row left to right): Vrms, Irms, Freq, Vthd, Horsepower, Derating, Active Power, Reactive Power, Power Factor, V neg/pos unbalance, I neg/pos unbalance. See next section Default Template Presets.

Custom - allows you to modify presets and save a custom set of cell channel/parameter settings according to user preference. See next section Custom Preset Setup.

Clear - resets the parameter display since the dashboard was enabled (when monitoring is on). Once cleared, the dashboard automatically proceeds to report meter data (or event count) anew.

Press Exit to return to the Real-time Data menu.

Parameter Details in Dashboard Display

Dashboard color scheme

The dashboard displays metered data for the selected parameter. The metered data is updated once per second. This is the same data that appears in the meter screen, and used in calculating journals. If the selected parameter is not journalled, the rms event or transient event count can be selected to appear in the dashboard instead of journalled data.

Disabled parameters appear in gray. A dashboard display is considered disabled if none of the limits were set. Also cells appear in gray when not monitoring.

Enabled parameters, on the other hand, are color-coded. A dashboard is active while the instrument is monitoring or by loading a previously saved file from memory. An active dashboard can have two or three states (Normal, Moderate, or Severe). When monitoring, parameters that are within limits are shown in green (indicates Normal state). Those that are moderately out of limits, exceeding Low or High threshold limits, are shown in yellow (indicates Moderate state). Parameters that are out of limits, exceeding Low or High threshold limits by 10% of in-limit span. Parameter indicator flashes in blinking red (indicates Severe state) if this function is turned on.

Default Template Presets

As mentioned, template presets for Power Quality, Energy/Demand, Motor Health, with factory-defined cell setups, are available for dashboard display. Template presets do not allow you to modify cell names and cell channel/parameter settings, however you can enable/disable alarm monitoring on each cell setup.

Action...	Result...
<p>STEP 1: From the Real-Time Data menu, press Dashboard.</p> <p>Press the preset category you want displayed - Power Quality, Energy/Demand, or Motor Health - and proceed to select a cell under the selected category.</p>	

Continued on next page

**Default
Template
Presets
(continued)**

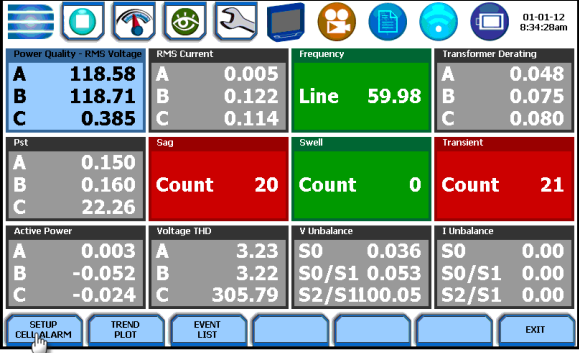
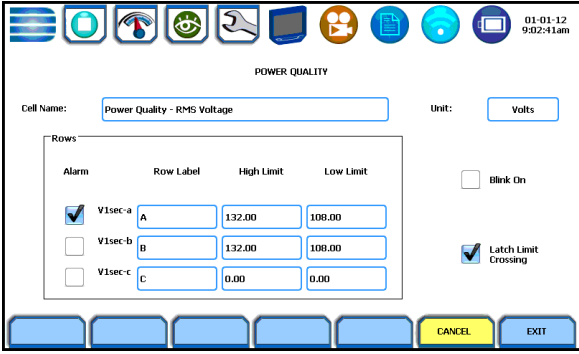
Action...	Result...
<p>STEP 2: The cell parameters for the selected category appear on the dashboard screen, and the function keys listed below are displayed.</p> <p>NOTE: Deselecting the cell will hide the keys from view. Selection will timeout and return to the previous dashboard screen in about ten (10) seconds.</p> <ul style="list-style-type: none"> To view (but not modify) cell property name, view parameter threshold limits and turn on/off alarm monitoring for the selected cell, press Setup Cell Alarm. Go to Step 3. To view plots of journalled data over time, press Trend Plot. Go to Chapter 6. To view the list of captured events, press Event List. Go to Chapter 6. <p>Press Exit to accept setup changes and return to previous screen.</p>	 <p style="text-align: right;">HDPQ-320</p>
<p>STEP 3: Once Setup Cell Alarm is selected, threshold values crossed that cause the parameter event, in this example V RMS, are displayed on screen.</p> <ul style="list-style-type: none"> Cell Name - specifies the cell parameter name. For template presets, Cell Name is not editable. Unit - pertains to the unit of measure of the cell parameter. The Unit name field is automatically filled out depending on the parameter selected and is not editable. 	 <p style="text-align: right;">HDPQ-321</p> <p>NOTE: Parameter thresholds are set by the Journal limit menu inside the wizard and cannot be changed in this menu.</p>

Continued on next page

**Default
Template
Presets
(continued)**

Action...	Result...
<p>STEP 3 (cont.):</p> <p>The Rows section displays the limits or range of values required for the parameter to pass QOS compliance.</p> <ul style="list-style-type: none"> • Alarm - use to to enable/disable the programmed limits. Check/Uncheck the Alarm box corresponding to the threshold values for which you want to enable/disable alarm monitoring. When monitoring is on, the dashboard displays the status of a parameter using a color scheme. Parameters that are out of limits, exceeding Low or High threshold limits, are shown in blinking red (indicates Severe state). • Limit fields (High Limit, Low Limit) - show the limit values used to program threshold values. • Blink On - use to enable/disable limit display function. Parameters that are out of limits, exceeding Low or High threshold limits, can be shown in blinking red (indicates Severe state) if this function is turned on. • Latch Limit Crossing - when enabled, the cell will stay red until you press Clear. When disabled, the cell will change colors depending on the current limit status. <p>Press Cancel to disregard setup changes and return to previous screen or press Exit to accept setup changes and return to previous screen.</p>	

Custom Preset Setup

The Custom button allows you to customize and save cell channel/parameter settings according to user preference. The steps below show how to modify channel/parameter settings in the dashboard display. Note that the same procedure applies even when you select different journal categories to plot.

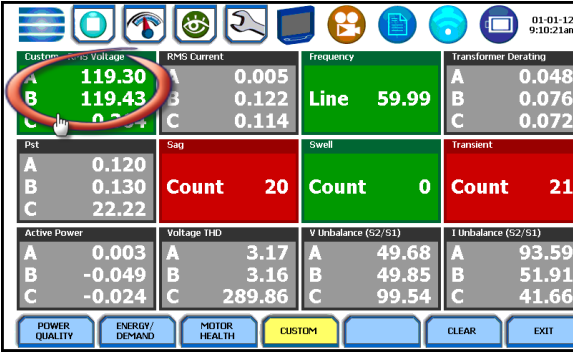
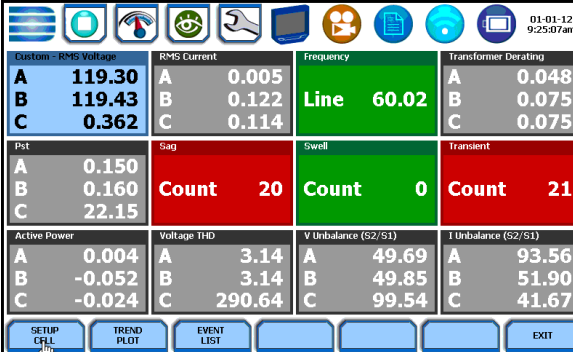
Action...	Result...
<p>STEP 1: From the Real-Time Data menu, press Dashboard.</p> <p>Press Custom on the Dashboard screen, and then proceed to select a cell that you want to set up and customize.</p>	 <p>HDPQ-322</p>
<p>STEP 2: The customizable cell parameters appear on the dashboard screen, and the function keys listed below are displayed.</p> <p>NOTE: Deselecting the cell will hide the keys from view. Selection will timeout and return to the previous dashboard screen in about ten (10) seconds.</p> <ul style="list-style-type: none"> • To view, modify and save cell parameter setups, press Setup Cell. Go to Step 3. • To view plots of journalled data over time, press Trend Plot. Go to Chapter 6. • To view the list of captured events, press Event List. Go to Chapter 6. <p>Press Exit to accept setup changes and return to previous screen.</p>	 <p>HDPQ-322</p> <p>NOTE: Parameter thresholds are set by the Journal limit menu inside the wizard and can not be changed in this menu.</p>

Continued on next page

Custom Preset Setup (continued)

Action...	Result...
<p>STEP 3: Once Setup Cell is selected, threshold values crossed that cause the parameter event, in this example V RMS, are displayed on screen.</p> <ul style="list-style-type: none"> • Cell Name - specifies the cell parameter name. For Custom presets, Cell Name is editable. Press the cell name field and use the alphanumeric key provided. • Unit - pertains to the unit of measure of the cell parameter. The Unit name field is automatically filled out depending on the parameter selected and is not editable. <p>The Rows section displays the limits or range of values required for the parameter to pass QOS compliance.</p> <ul style="list-style-type: none"> • Alarm - use to to enable/disable the programmed limits. Check/Uncheck the Alarm box corresponding to the threshold values for which you want to enable/disable alarm monitoring. When monitoring is on, the dashboard displays the status of a parameter using a color scheme. Parameters that are out of limits, exceeding Low or High threshold limits, are shown in blinking red (indicates Severe state). • Limit fields (High Limit, Low Limit) - shows the limit values used to program threshold values. 	<p>The top screenshot (HDPQ-324) displays the 'CUSTOM' configuration screen. The 'Cell Name' is 'Custom - RMS Voltage' and the 'Unit' is 'Volts'. A table titled 'Rows' contains three rows (A, B, C) with 'Alarm' checkboxes and 'High Limit' and 'Low Limit' values. Row A has High Limit 132.00 and Low Limit 108.00. Row B has High Limit 132.00 and Low Limit 108.00. Row C has High Limit 0.00 and Low Limit 0.00. There are also checkboxes for 'Blink On' and 'Latch Limit Crossing'. Buttons at the bottom include PARAMETER, SAG, SWELL, TRANSIENT, BLANK, CANCEL, and EXIT.</p> <p>The bottom screenshot (HDPQ-325) shows the same screen with a keyboard overlay for editing the 'Cell Name' field. The keyboard includes a numeric row, a QWERTY row, an ASDFGHJKL row, a ZXCVBNM-Shift row, and buttons for Clear All, Space, OK, and Cancel.</p>

Continued on next page

**Custom Preset Setup
(continued)**

Action...	Result...
<p>STEP 3 (cont.):</p> <ul style="list-style-type: none"> • Blink On - use to enable/disable limit display function. Parameters that are out of limits, exceeding Low or High threshold limits, can be shown in blinking red (indicates Severe state) if this function is turned on. • Latch Limit Crossing - when enabled, the cell will stay red until you press Clear. When disabled, the cell will change colors depending on the current limit status. <p>The following function keys appear at the bottom of the screen:</p> <ul style="list-style-type: none"> • Parameter - press to view/modify the cell's channel/parameter settings. Proceed to Step 4. • Sag/Swell/Transient - press one of these buttons to program the cell to show Sag, Swell or Transient event counts. Proceed to Step 5. • Blank - press if you want to delete or remove the cell parameter from the dashboard. To add a new cell parameter, return to Setup Cell and select the parameter you want to add (Parameter, Sag, Swell or Transient). <p>Press Cancel to disregard setup changes and return to previous screen or press Exit to accept setup changes and return to previous screen.</p>	

Continued on next page

Custom Preset Setup (continued)

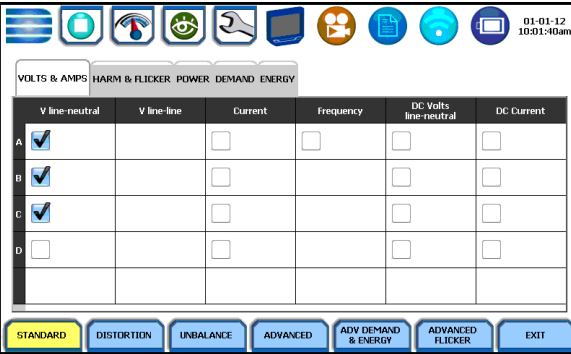
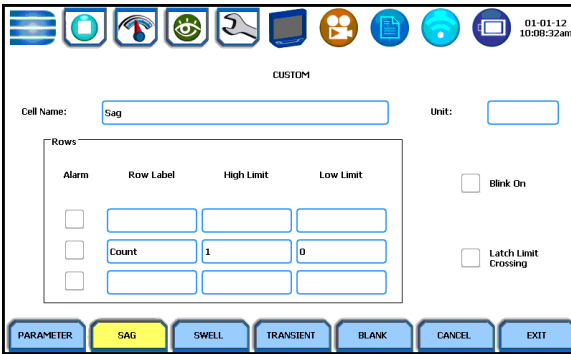
Action...	Result...
<p>STEP 4: Once Parameter is pressed, the Change Parameter/ Channel window showing groupings and arrangements of parameter/channel combinations, is displayed.</p> <p>Check your desired parameter/ channel and then click on Exit to view the selections made. Refer to Chapter 3 Real Time Data for the list of parameters available for display.</p>	 <p>HDPQ-326</p>
<p>STEP 5: Once Sag/Swell/ Transient is pressed, the pre-defined trigger event count for the selected cell, in this example the Sag cell, is displayed on screen.</p> <ul style="list-style-type: none"> • Cell Name - specifies the cell parameter name. For Custom presets, Cell Name is editable. Press the cell name field and use the alphanumeric key provided. • Unit - pertains to the unit of measure of the cell parameter. The Unit name field is automatically filled out depending on the parameter selected and is not editable. <p>The Rows section displays the threshold event count required for the parameter to pass QOS compliance</p>	 <p>HDPQ-327</p>

Continued on next page

Custom Preset Setup (continued)

Action...	Result...
<p>STEP 5 (cont.):</p> <ul style="list-style-type: none"> • Alarm - use to enable/disable the programmed event count. Check/Uncheck the Alarm box corresponding to the threshold event count for which you want to enable/disable alarm monitoring. When monitoring is on, the dashboard displays the status of a parameter using a color scheme. Parameters that exceed the threshold event count, are shown in blinking red (indicates Severe state). • Limit fields (High Limit, Low Limit) - shows the limit values used to program threshold values. • Blink On - use to enable/disable limit display function. Parameters that are out of limits, exceeding Low or High threshold limits, can be shown in blinking red (indicates Severe state) if this function is turned on. • Latch Limit Crossing - when enabled, the cell will stay red until you press Clear. When disabled, the cell will change colors depending on the current limit status. <p>Press Cancel to disregard setup changes and return to previous screen or press Exit to accept setup changes and return to previous screen.</p>	

Section E

Voltage and Current Phasor

Overview

Phasor display The phasor screen displays a graph that indicates the phase angle and magnitude relations between the voltage and current based upon the angles of the fundamentals, as determined by Fourier analysis.

Phasor screen shows eight phasors autoscaled with zero degrees to the right (normally channel A voltage) for counterclockwise rotation and with synchronized channels. You may display up to four channels at any one time for either volts or amps, or a single channel for both volts and amps, depending on the phases being monitored.

A touch screen Demo button presents an animated phasor demo rotation for resistive, capacitive and inductive loads.

In this section The following topics are covered in this section.

Topic	See Page
Phasor Screen	3-31
Phasor Rotation	3-32
Phasor Channel/Parameter Selection	3-34

Phasor Screen

Phasor screen display

The Phasor window is displayed by pressing **Phasor** from the Real-Time Data menu or by pressing the Phasor real-time metering icon on the work area of the Home Monitoring page.

The Phasor window shows eight phasors autoscaled with zero degree to the right for clockwise rotation and with synchronized channels. The left sidebar shows rms values for Volts/Amps for channels A, B, C and D. The right sidebar shows zero, positive and negative values for Volts/Amps; zero, positive and negative sequence component values for Volts/Amps; as well as negative zero imbalance and maximum deviation imbalance.

Depending on the phases being monitored, up to four channels may be displayed at any one time for either Volts or Amps, or a single channel for both Volts and Amps. An arrow head and channel label are displayed on the vector.

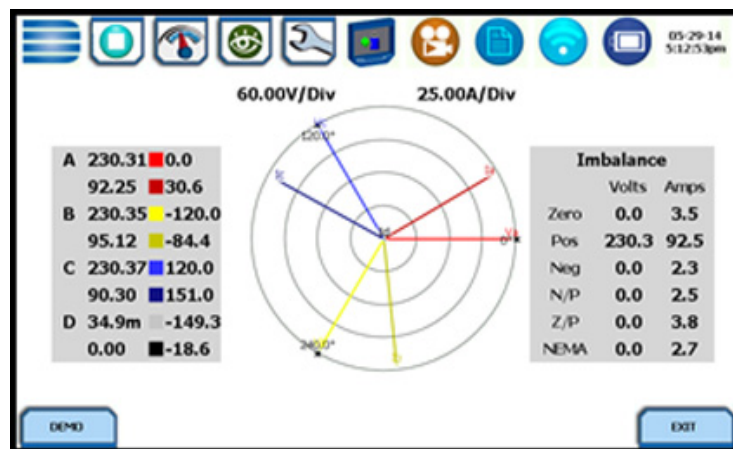

HDPQ-328

Phasor Rotation

Animated phasor rotation

Graphic illustration in the form of rotating phasors relative to the sine wave graph of a four wire wye circuit is available by pressing the **Demo** button on the Phasor window. The Demo key will be replaced by Start/Stop once phasor rotation has been viewed. Press Start to replay animated phasor rotation. You can choose to Stop the phasor demo rotation at any time.

Phasor vectors are displayed using a counterclockwise rotation from the zero degrees reference. Animated phasor demo for Resistive, Inductive and Capacitive loads is available for viewing.

Sample 3-Phase, three wire delta rotation

The following diagrams describe the positive phase rotation of voltage and current phasors (for Resistive, Inductive and Capacitive loads) for a three phase, three wire delta connection. An arrow head on the line indicates direction pointing toward the load.

Three phase vectors are displayed as three lines, 120 degrees apart in a Resistive load

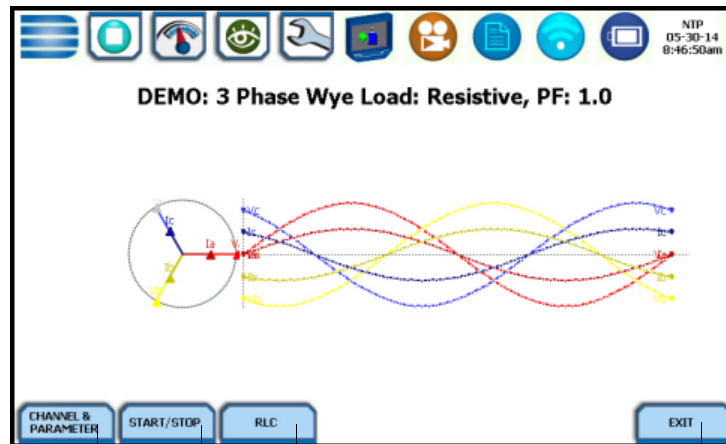

- Display channel/parameter selection
- Start/Stop demo plot waveforms as rotate phasors; press any time
- Switch phasor demo rotation between Resistive, Inductive and Capacitive load effects; press any time
- Return to Phasor screen

Continued on next page

**Sample 3-Phase,
three wire delta
rotation
(continued)**

The following diagrams describe the positive phase rotation of voltage and current phasors (for Resistive, Inductive and Capacitive loads) for a three phase, three wire delta connection. An arrow head on the line indicates direction pointing toward the load.

Three phase vectors are displayed as three lines, 120 degrees apart in an Inductive load

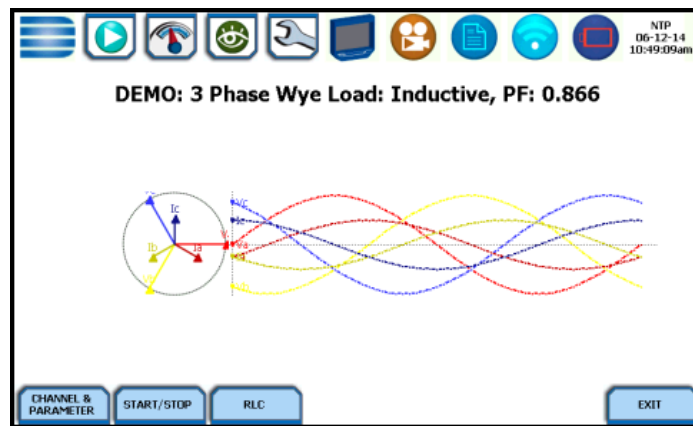

HDPQ-330

Three phase vectors are displayed as three lines, 120 degrees apart in a Capacitive load

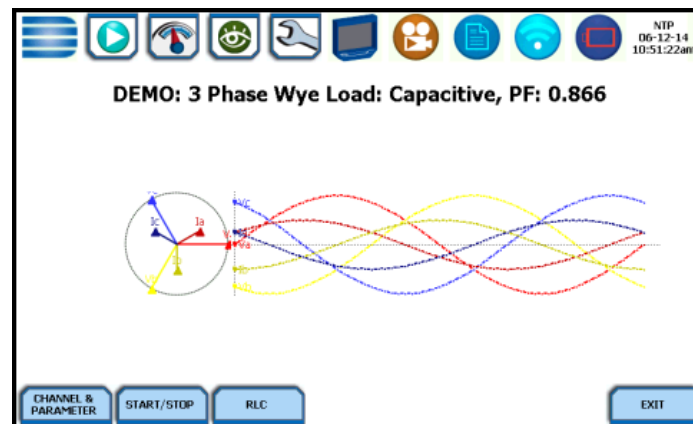

HDPQ-331

**Phasor
diagrams**

Refer to Appendix E for the diagrams that describe the voltage and current phasors for the standard type of power connections.

Phasor Channel/Parameter Selection

Channel/ Parameter display

The Channel/Parameter selection screen is displayed by pressing **Channel & Parameter** on the phasor Demo window. Depending on the phases being monitored, up to three channels may be displayed at any one time for both Volts or Amps.

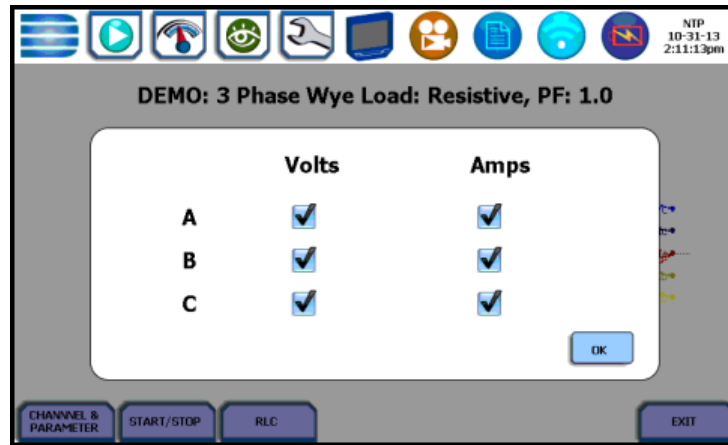

HDPQ-332

Press to enable/disable the channel/parameter for display in the animated phasor rotation.

- Press the desired **Volts/Amps channel** to turn it on/off.

NOTE: Only one parameter/channel selection is possible at a time.

Press **OK** to save any changes made and return to the Phasor Demo window. The phasor demo rotations will display the parameters/channels enabled.

Section F

Harmonics

Overview

Harmonics display

HDPQ Xplorer allows you to view voltage and current harmonics/interharmonics in graphical or in tabular form. Harmonics are waveform distortion, steady-state deviations from an ideal power frequency sinusoid and are characterized by the spectral content of the waveform. Interharmonics are frequency components between the harmonic frequencies. The IEC 61000-4-7 and IEEE 519 Standards dictate that harmonic analysis is done using a synchronous window of 10 cycles for 50 Hz, or 12 cycles for 60 Hz. This results in bins which are nominally 5 Hz wide. The actual width of the bins is equal to the actual frequency divided by 10 if the nominal frequency is 50 Hz, and 12 if 60 Hz. For example, if actually operating at 49.9 Hz, the bin is 4.99 Hz, but is labelled “5 Hz” as specified by the standard.

You can determine the number or range of harmonic frequencies to trend and view in detail. There is also the option to select how to plot harmonic/interharmonic data and specify the units of measure by which harmonic data is calculated.

Harmonic Graph: Harmonics are measured in accordance with IEC 61000-4-7 Class 1 and IEEE 519. You can choose the unit of measure by which harmonic data is calculated and graphed, based on a Percentage of the fundamental value or in Engineering units (volts and amps). Frequency components of harmonic graphs can be displayed either in Hertz or in Harmonic Number. The graphs can be zoomed and rescaled.

Harmonic Table: Harmonic list gives a tabular display of the following for each of the measured values: frequency and harmonic number; magnitude in Engineering units and percent of fundamental; phase in degrees (for harmonics only). Harmonic table values are displayed in order of ascending frequency, and can also be sorted in order of descending magnitude.

Harmonic screen and function keys

Harmonic graph can be displayed by pressing **Harmonics** from the Real-Time Data menu or by pressing the Harmonics real-time metering icon on the work area of the Home Monitoring page. Note that the window defaults to a graphical spectrum display, similar to sample screen shown below. Use the function keys at the bottom of the screen to set up the harmonics graph/table.

Continued on next page

Harmonic screen and function keys (continued)

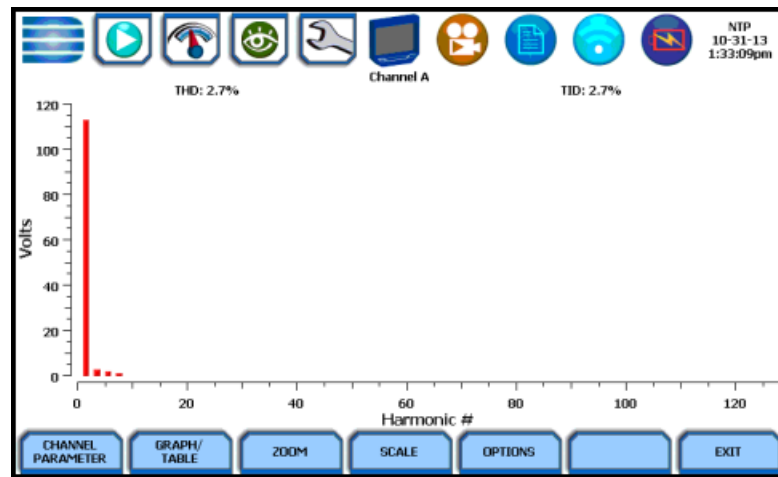

HDPQ-333

Channel Parameter - allows you to change and select your desired channel/parameter with which to create the harmonic graph/table. If you press this, the Change Parameter/Channel window pops up showing groupings and arrangements of parameter/channel combinations. One channel/parameter combination can be displayed at a time for the spectrum graph, magnitude list, or phase angle list for the harmonics. See Harmonic Channel/Parameter Selection.

Graph/Table - toggles between harmonic graph and tabular display. The screen defaults to a graphical spectrum display, although you have the option to choose between the graph or table form. The screen will show a spectral graph featuring the amplitude of the harmonics relative to the fundamental frequency, as shown above. For harmonic table display, see Harmonic Graph/Table.

Zoom - allows you to magnify and view harmonic graphs in detail. See Harmonic Detail.

Scale - allows you to step through the vertical scale maximum value by 100%, 50%, 25% to 10%.

Options - allows you to select the vertical and horizontal measurement scale. The percent magnitude of the first 127 harmonics are graphed relative to the fundamental. See Harmonic Options.

The **Exit** key returns to the Real Time Data menu.

In this section

The following topics are covered in this section.

Topic	See Page
Harmonic Channel/Parameter Selection	3-37
Harmonic Graph/Table	3-38
Harmonic Detail	3-40
Harmonic Options	3-41

Harmonic Channel/Parameter Selection

Channel/ Parameter display

From the Harmonic Graph window, press **Channel Parameter** to turn Volts/Amps/Watts channel selection on/off. One channel/parameter combination can be displayed at a time for the spectrum graph, magnitude list, or phase angle list for the harmonics. Selections can be made from Channels A, B, C and D, and Parameters V, I, W.

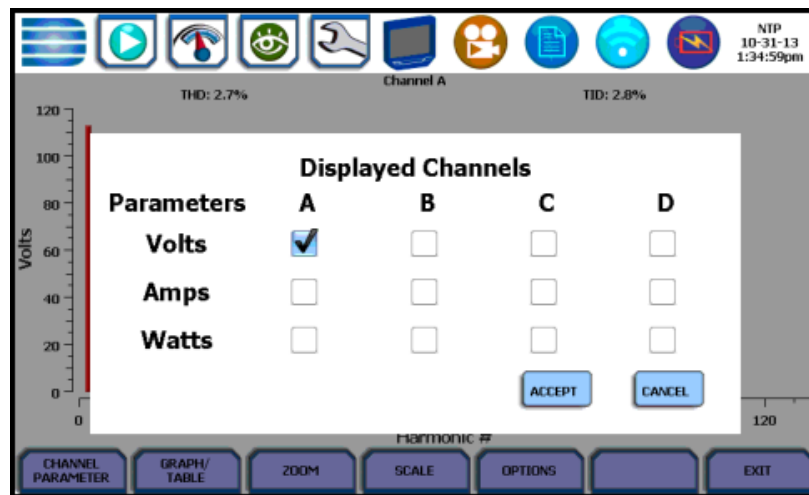

HDPQ-334

Doing any of the following actions will turn channels/parameters on/off:

- Press the desired **Volts/Amps/Watts channel** to turn it on/off.

NOTE: Only one parameter/channel selection is possible at a time.

Press **Accept** to save any changes made and return to harmonic display with channels as displayed in the check boxes.

Press **Cancel** to return to harmonic display without changing any of the displayed channels.

Harmonic Graph/Table

Harmonic graph/table display

The Graph/Table function key toggles between spectrum graph to table of magnitude and phase in text form. Use this key if you want to switch views between harmonic graph to harmonic magnitude table, as shown below.

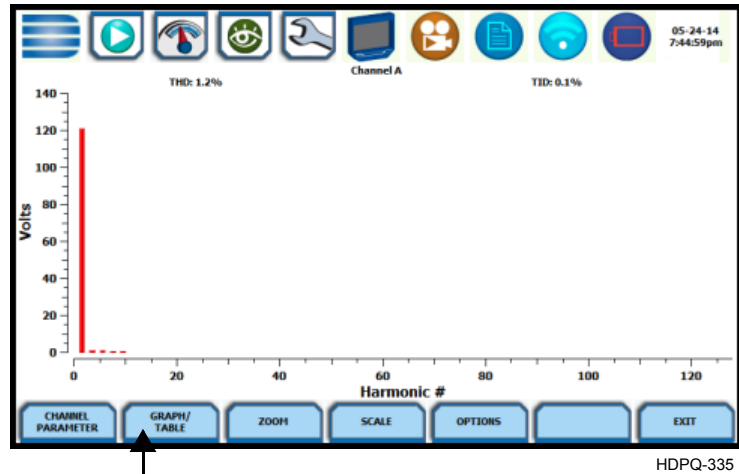

Hz	Harmonic	Volts	Channel A Harmonic Details	Phase Degrees
DC		49.5m	0.0%	0.0'
60	1	121.04	100.0%	0.0'
120	2	87.6m	0.1%	0.0'
180	3	974m	0.8%	0.0'
240	4	110m	0.1%	0.0'
300	5	1.25	1.0%	0.0'
360	6	35.8m	0.0%	0.0'
420	7	568m	0.5%	0.0'

HDPQ-336

The harmonic parameters displayed on list include: (from leftmost column) the harmonic/interharmonic frequency in Hz, frequency in number, voltage rms or maximum load of current (depending on parameter selected), percent amplitude of harmonics, and harmonic phase angle value.

By default, harmonic and interharmonic frequency values are arranged in order of increasing frequency. Use the Sort button to organize harmonic text display in order of decreasing magnitude. The harmonic values are shown in boldface.

Harmonic graph/table display (continued)

Harmonic phase degree values from 1 to 127 are displayed for voltage and current; phase degree values from 1 to 127 are displayed for harmonic watts. Harmonic phase angle values can be normalized to the phase of the fundamental of the displayed channel. Use the Norm button to show the normalized phase angle values.

Hz	Harmonic	Volts	Channel A Harmonic Details	Phase Degrees
DC		48.8m	0.0%	0.0'
60	1	121.25	100.0%	0.0'
120	2	50.4m	0.0%	0.0'
180	3	825m	0.7%	0.0'
240	4	53.4m	0.0%	0.0'
300	5	1.11	0.9%	0.0'
360	6	39.9m	0.0%	0.0'
420	7	635m	0.5%	0.0'

HDPQ-337

Toggle between Normalized and UnNormalized phase values

Organize harmonic text display in order of decreasing magnitude

Hz	Harmonic	Volts	Channel A Harmonic Details	Phase Degrees
60	1	120.63	100.0%	0.0'
300	5	1.12	0.9%	0.0'
180	3	867m	0.7%	0.0'
420	7	630m	0.5%	0.0'
540	9	266m	0.2%	0.0'
660	11	162m	0.1%	0.0'
1020	17	89.3m	0.1%	0.0'
780	13	83.1m	0.1%	0.0'

HDPQ-338

Harmonic Detail

Harmonic graph details HDPQ Xplorer allows you to determine the number or the range of harmonic frequencies to trend.

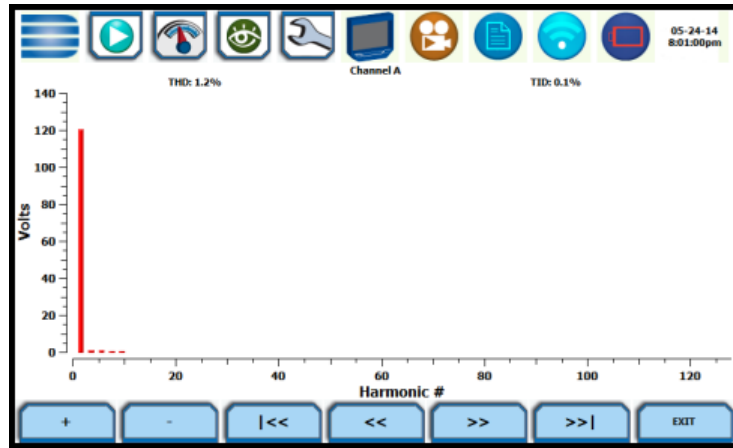

HDPQ-339

The Zoom function allows you to zoom in/out of the plot display using the controls described below.

- Zoom In (+) - press to zoom in the amount defined by the zoom box; press Zoom+ to display the zoomed area and view event cycles in greater detail. You may repeatedly zoom in on a plot for up to seven (7) bins.
- Zoom Out (-) - press Zoom-(n) to unzoom the last step.
- Go to start (|<<) - single action; displays plot to the beginning of the harmonic range.
- Pan Left (<<) - press to step to 10% lower in harmonic range.
- Pan Right (>>) - press to go up 10% in harmonic range.
- Go to end (>>|) - single action; displays plot to the end of the harmonic range, and shows one screen's worth of data.
- Exit - single action; return to the previous screen.

Harmonic Options

Harmonic/ Interharmonic data plots

The voltage and current harmonics and/or interharmonics for each phase channel can be trended using the Options button. The properties specified under Harmonic Options apply when harmonic/interharmonic data is viewed in either graph or tabular form.

Properties under **Calculate Harmonics as** pertain to both the graph and the table, and determine how the harmonics and interharmonics are used.

If calculate **Harmonics only** is enabled, then only the actual harmonics are shown.

If calculate **Harmonics and interharmonics** is enabled, the spectrum will include all the (nominal) 5 Hz bins, which includes the actual interharmonics as well. On the graph, the harmonics are shown in the channel color, while interharmonics are shown in gray color. On the table, the harmonics are shown in boldface.

If calculate **including adjacent harmonics** is enabled, the interharmonics are not explicitly shown but the harmonic values include the adjacent interharmonic values in their calculation, as specified by IEC 61000-4-7 or IEEE 519.

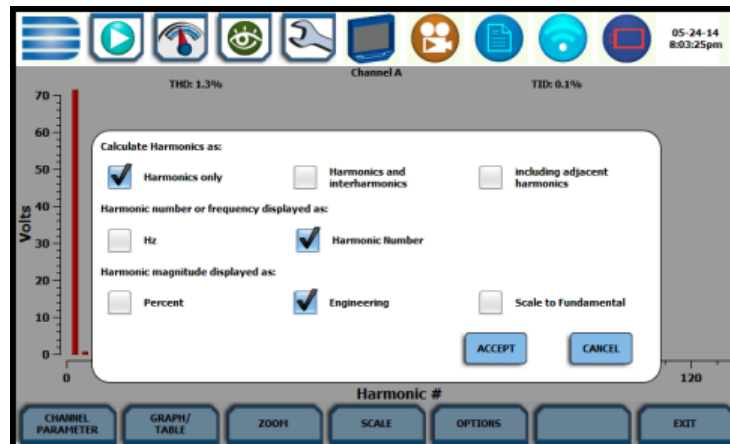

HDPQ-340

The rest of the properties under harmonic options described below pertain to the way the graph (not the table) is labelled.

The horizontal axis can be in **Hz** or **Harmonic Number**.

The vertical scale can be in **Percent** or **Engineering** units, and **Scale to Fundamental** (full scale) can be chosen to be the fundamental at 100% or the largest component. The engineering unit for voltage is volts and for current is amperes.

Press **Accept** to save any changes made and return to harmonic display with channels as displayed in check boxes.

Press **Cancel** to return to harmonic display without changing any of the displayed channels.

Harmonic computation

The IEC 61000-4-7 and IEEE 519 Standards specify that the interharmonic bins adjacent to the harmonic be included in the computation of that harmonic called grouping, for example, if there was a 3rd harmonic (150 Hz) of 10%, and the value of the 145 Hz bin was 1%, and the value of the 155 Hz bin was 2%, then the value reported in the bin labelled “150 Hz” would also include contributions from the 145 Hz and 155 Hz bins. This would give approximately 10.2%, not 10%.

The following graphs illustrate harmonic computation as per IEC 61000-4-7 Standard.

Harmonic Computation for 50 Hz

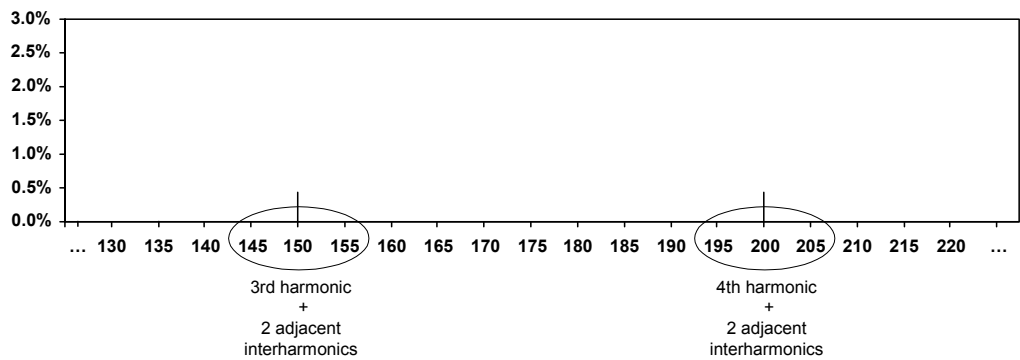

Harmonic Computation for 60 Hz

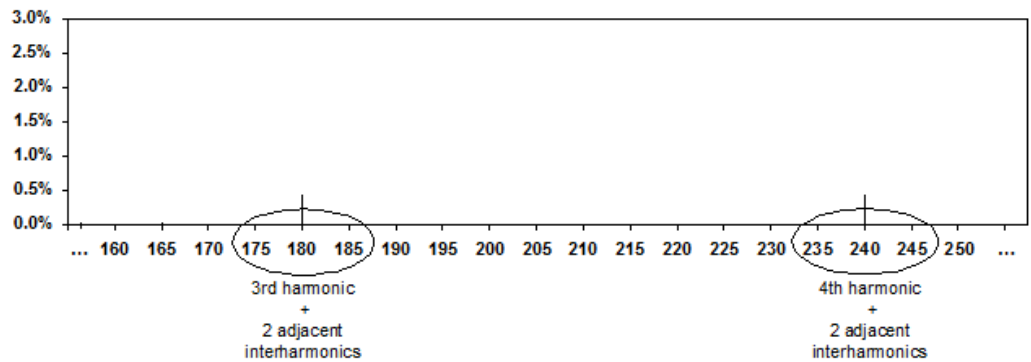

Section G

Strip Chart Recorder

Overview

Introduction

Strip Chart Recorder displays a real-time auto-scaled graph of selected parameters, updated once every 3 seconds. The initial strip chart screen records up to 10-minutes worth of horizontal scale data, with the vertical axis also initially on auto-scale. Once the 10-minutes worth of data is complete, the horizontal scale continues to shift forward in time with each update. This process continues until the Clear function key is pressed.

Strip chart display

The Strip chart screen can be displayed by pressing **Strip Chart Recorder** from the Real-Time Data menu.

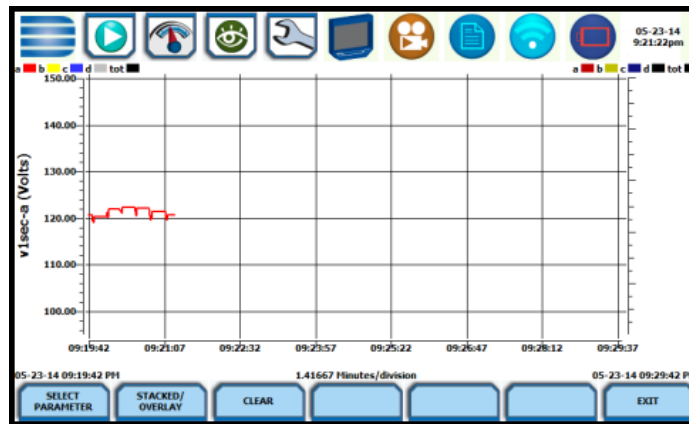

HDPQ-341

Function keys

Use the function keys at the bottom of the screen to set up the strip chart recorder.

Select Parameter - allows you to change and select parameters to plot. If you press this, the Change Parameter/Channel window pops up showing groupings and arrangements of parameter/channel combinations. You have the option to enable/disable channels for any of the single or dual axis plot display. The plot display area will resize according to the number of parameters/channels enabled/disabled for display.

Stacked/Overlay - toggles between single or multiple axis plot views. This function allows you to view all voltage and current channels in the same, single axis plot or in separate, multiple or dual axis plots. Multiple stacked plot displays plots with voltage and current pairs from same channel appearing on the same graph. Dual stacked plot has one plot showing all voltage channels and one plot showing all current channels.

Clear - clears the parameter display on plot since the strip chart was enabled. Once cleared, the strip chart automatically proceeds to record data anew.

The **Exit** key returns to the Real-Time Data menu.

This page intentionally left blank.

CHAPTER 4



Setup Monitoring

Overview

Start menu options

The Start Menu allows you to perform the following: set up HDPQ Xplorer for monitoring of an electrical system, load previously saved setups, and load data files from memory.

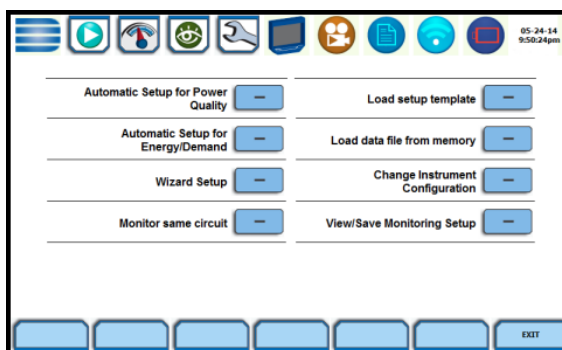

HDPQ-401

There are two ways to set up the instrument for monitoring - via Automatic Setup or Wizard Setup. Experienced users have the ability to turn on any available parameter and set threshold limits to any value within the acceptable range. The length of time to monitor a circuit can vary from a few hours to a few months or more depending on the user application.

Automatic Setup automatically configures the instrument's circuit type, voltage and current channels, and parameter thresholds. The auto-configured setup enables you to proceed directly with data monitoring. HDPQ Xplorer allows you to perform automatic setup for power quality or for energy/demand, depending on your application.

Wizard Setup takes you through a series of screens prompting for information about the circuit to be monitored and monitoring settings. The instrument turns on the appropriate voltage and current channels when you select a circuit type. Parameter thresholds are initially set based on the line voltage and current values that you enter. Threshold limits for capturing events are also set according to the monitoring mode selected. Selection of a setup mode typically depends on the user's application and extent of familiarity with the operation of the instrument.

Monitor same circuit makes use of the previous setup for monitoring.

Load setup template allows you to load previously saved setup templates from internal memory or from an external USB device.

Load data file from memory brings up a list of recorded session data files containing recordings that are saved to memory while monitoring is on.

Change Instrument Configuration brings up the instrument settings menu to help you manage the instrument according to your setup preferences and application.

View/Save Monitoring Setup displays the list of parameter settings for application setup.

Displaying Start Menu Follow these steps to display the Start Menu.

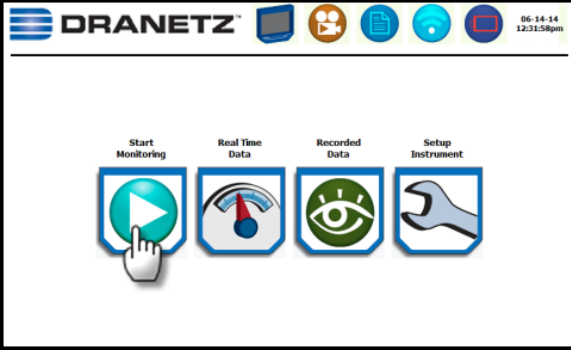
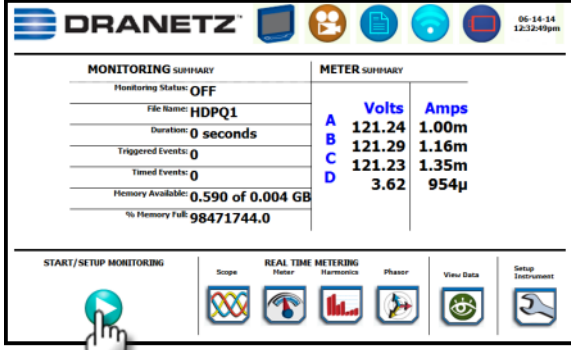
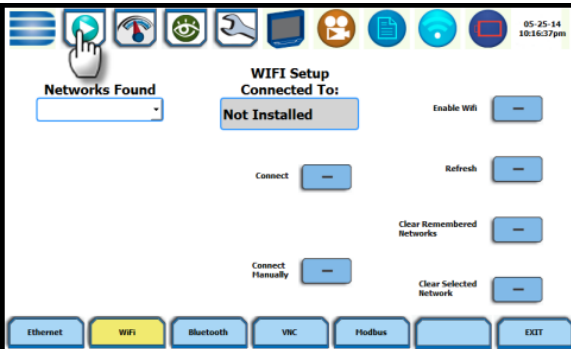
Action...	Result...
<p>STEP 1: There are three (3) ways to access the Start Monitoring icon:</p> <p>1st: Upon instrument power-up and prior to monitoring, the Home page displays shortcut buttons, one of which is Start Monitoring. Proceed to Step 2.</p> <p>NOTE: Repeated pressing of the Dranetz logo, located at the top left of the taskbar, alternates between the Home page and the Home Monitoring page (screen below), back and forth.</p>	 <p>HDPQ-110a</p>
<p>2nd: The Home Monitoring page also displays the icon to Start Monitoring.</p> <p>NOTE: The Start Monitoring icon changes into Stop Monitoring when monitoring is on.</p> <p>The instrument should be able to detect data for monitoring.</p>	 <p>HDPQ-111c</p>
<p>3rd: Start/Stop Monitoring icon is also accessible on the taskbar of most typical screens, where shortcuts to common instrument functions are found.</p> <p>Example: You can access Start/Stop Monitoring from the taskbar of the Communications setup screen.</p>	 <p>HDPQ-302</p>

Continued on next page

**Displaying Start Menu
(continued)**

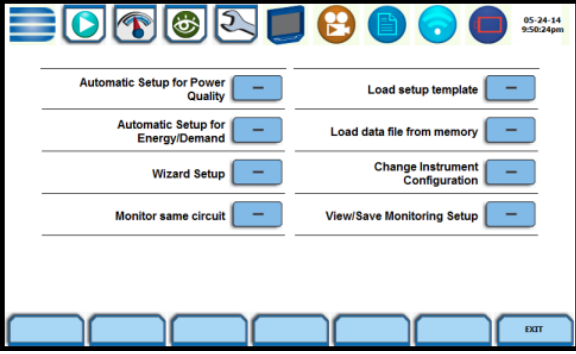
Action...	Result...
<p>STEP 2: Start Menu contains menu selections for Automatic Setup for Power Quality, Automatic Setup for Energy/Demand, Wizard Setup, Monitor same circuit, Load setup template, Load data file from memory, Change Instrument Configuration and View/Save Monitoring Setup. Refer to the particular section for information on each function.</p>	 <p>The screenshot shows a software interface with a top bar containing several icons (power, play, signal, eye, wrench, monitor, camera, document, globe, and a red square) and a timestamp '05-24-14 9:50:24pm'. Below the icons are eight menu items, each with a blue button and a minus sign: 'Automatic Setup for Power Quality', 'Automatic Setup for Energy/Demand', 'Wizard Setup', 'Monitor same circuit', 'Load setup template', 'Load data file from memory', 'Change Instrument Configuration', and 'View/Save Monitoring Setup'. At the bottom of the interface are several blue buttons, including one labeled 'EXIT'. The text 'HDPQ-401' is visible in the bottom right corner of the screenshot.</p>

In this chapter

This chapter is divided into eight sections:

Section	Title	See Page
A	Automatic Setup for Power Quality	4-4
B	Automatic Setup for Energy/Demand	4-7
C	Wizard Setup	4-10
D	Monitor Same Circuit	4-49
E	Load Setup Template	4-55
F	Load Data File from Memory	4-56
G	Change Instrument Configuration	4-58
H	View/Save Monitoring Setup	4-59

Section A

Automatic Setup for Power Quality

Overview

Automatic Setup procedure

Automatically configures the setup for monitoring quality of supply based on IEEE and IEC typical trigger settings. Automatic Setup is a one-stop process using pre-defined values to set up the unit automatically. You have the option to view the summary list of parameter settings, change probe types if current will be monitored, and/or proceed directly with data monitoring. Follow these steps to perform Automatic Setup for PQ.

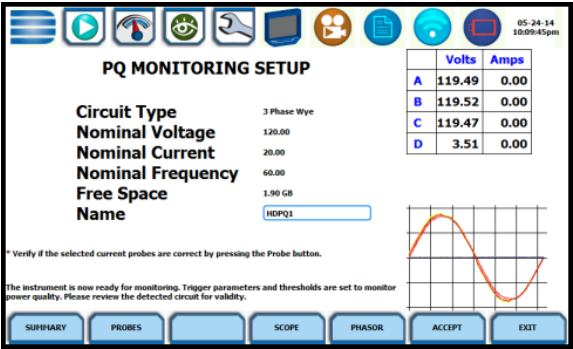
Action...	Result...
<p>STEP 1: From the Start Menu, press Automatic Setup for Power Quality. The auto-configured circuit type, nominal voltage, current and frequency values appear on screen. The remaining free space in GB is shown, and you have the ability to specify the name in which the PQ setup file can be saved.</p> <ul style="list-style-type: none"> To view the list of parameter settings for Automatic Setup, press Summary. Proceed to Step 2 on page 4-5. To display/change probe types for current monitoring, press Probes. Proceed to Step 3 on page 4-5. To display real-time waveforms of voltage and current for enabled channels, press Scope. By default, the Scope diagram is already displayed at the bottom right corner of the screen. To display voltage and current phasors for all enabled channels, press Phasor. The Phasor diagram replaces Scope at the bottom right of screen. Press Accept to save any changes made and return to the Home Monitoring page with monitoring ON. Press Exit to return to the Start Menu without changing the monitoring status. 	 <p>NOTE 1: If the message “No valid wiring configuration found” comes up, you must connect the inputs to a live circuit or override circuit type in the Wizard Setup. You need to configure the circuit type appropriate to your application.</p> <p>NOTE 2: List of default settings for Automatic Setup for Power Quality can be found in Appendix B Technical Specifications.</p>

Automatic Setup procedure (continued)

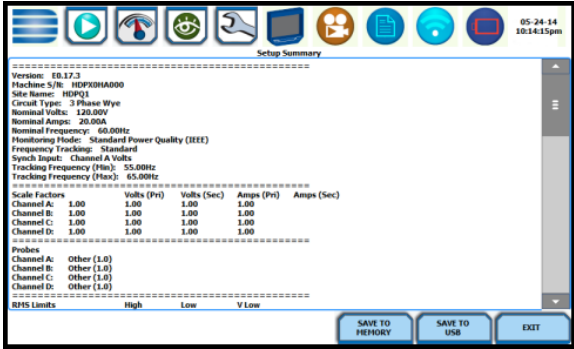
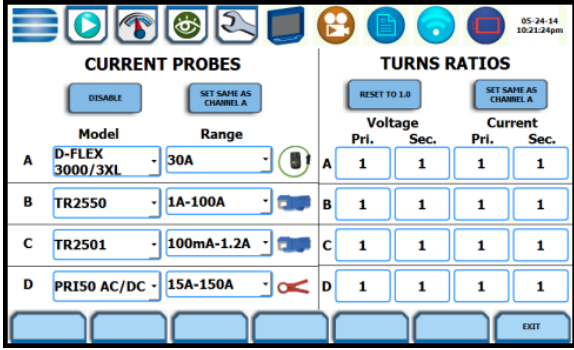
Action...	Result...
<p>STEP 2: Summary displays the list of parameter settings for Automatic Setup for Power Quality. The setup summary is available for review before, during and after monitoring.</p> <ul style="list-style-type: none"> • Press and drag the scroll bar to move the page up or down. • When done reviewing the Setup Summary, press Exit. The screen will return to Automatic Setup for Power Quality. 	 <p>HDPQ-403</p>
<p>STEP 3: Various probe types are available for each channel for current monitoring.</p> <p>Probe Selection</p> <ul style="list-style-type: none"> • If current will be monitored, press the corresponding Probe Channel/Parameter window to display the probe types available for each channel. • If you want to make all channels have the same setup as Channel A current, press Set Same as Channel A. The display will change to show only one probe selection for all channels. Press the window drop down arrow to display the probe types available. • Select your desired probe type. • Range corresponds to the usable input range for each probe type. • If the current probe that you are using is not on the list, select Other. Then set the Scale to define the CT scale factor on the current probe. 	 <p>HDPQ-404</p>

Continued on next page

**Automatic Setup
procedure
(continued)**

Action...	Result...
<p>CT Scale Factor Set the CT scale factor when using a current probe that is not on the list or if there are additional scale factors from other CTs in the system that need to be taken into account. See sample scale factor calculation on page 4-15.</p> <ul style="list-style-type: none"> • To reset all of the V and I Scale factors to the default value 1.0, press to enable Reset to 1.0. • To make all of the channels have the same scale factors as Channel A current and voltage, press Set Same as Channel A. The display will change to show only one scale factor value for all V and I channels. Press the scale factor window to enter the CT scale factor on the current probe. • Press the corresponding Scale Channel/Parameter to show the numeric window to enter the CT scale factor on the current probe. • Pressing Exit will return the Auto Setup page. 	

Section B

Automatic Setup for Energy/Demand

Overview

Automatic Setup procedure

Automatically configures the setup for monitoring energy/demand. Automatic Setup is a one-stop process using pre-defined values to set the unit automatically. You have the option to view the summary list of parameter settings, change probe types if current will be monitored, and/or proceed directly with data monitoring. Follow these steps to perform Automatic Setup for Energy/Demand.

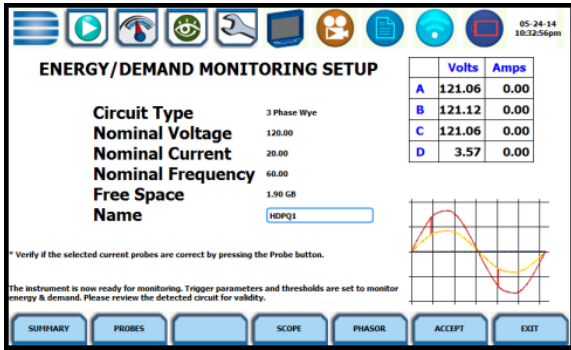
Action...	Result...
<p>STEP 1: From the Start Menu, press Automatic Setup for Energy/Demand. The auto-configured circuit type, nominal voltage, current and frequency values appear on screen. The remaining free space in GB is shown, and you have the ability to specify the name in which Energy/Demand setup file can be saved.</p> <ul style="list-style-type: none"> To view the list of parameter settings for Automatic Setup, press Summary. Proceed to Step 2 on page 4-8. To display/change probe types for current monitoring, press Probes. Proceed to Step 3 on page 4-8. To display real-time waveforms of voltage and current for enabled channels, press Scope. By default, the Scope diagram is already displayed at the bottom right corner of the screen. To display voltage and current phasors for all enabled channels, press Phasor. The Phasor diagram replaces Scope at the bottom right of screen. Press Accept to save any changes made and return to the Home Monitoring page with monitoring ON. Press Exit to return to the Start Menu without changing the monitoring status. 	 <p>NOTE 1: If the message “No valid wiring configuration found” comes up, you must connect the inputs to a live circuit or override circuit type in the Wizard Setup. You need to configure the circuit type appropriate to your application.</p> <p>NOTE 2: List of default settings for Automatic Setup for Energy/Demand can be found in Appendix B Technical Specifications.</p>

Automatic Setup procedure (continued)

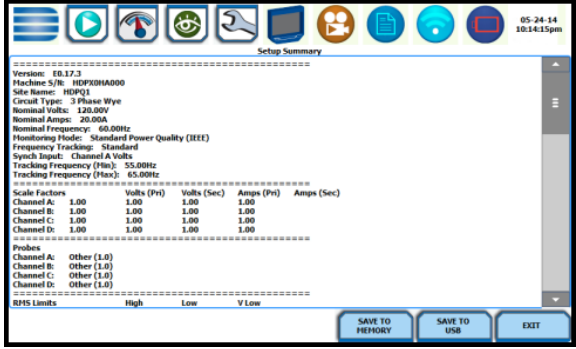
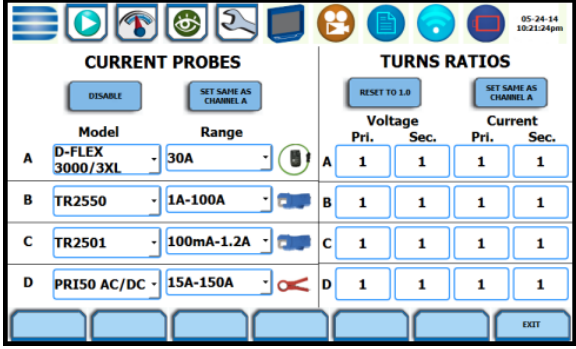
Action...	Result...
<p>STEP 2: Summary displays the list of parameter settings for Automatic Setup. The setup summary is available for review before, during and after monitoring.</p> <ul style="list-style-type: none"> Press and drag the scroll bar to move the page up or down. When done reviewing the Setup Summary, press Exit. The screen will return to Automatic Setup for Energy/Demand. 	 <p style="text-align: right;">HDPQ-403</p>
<p>STEP 3: Various probe types are available for each channel for current monitoring.</p> <p>Probe Selection</p> <ul style="list-style-type: none"> If current will be monitored, press the corresponding Probe Channel/Parameter window to display the probe types available for each channel. If you want to make all channels have the same setup as Channel A current, press Set Same as Channel A. The display will change to show only one probe selection for all channels. Press the window drop down arrow to display the probe types available. Select your desired probe type. Range corresponds to the usable input range for each probe type. If the current probe that you are using is not on the list, select Other. Then set the Scale to define the CT scale factor on the current probe. 	 <p style="text-align: right;">HDPQ-404</p>

Continued on next page

**Automatic Setup
procedure
(continued)**

Action...	Result...
<p>CT Scale Factor Set the CT scale factor when using a current probe that is not on the list or if there are additional scale factors from other CTs in the system that need to be taken into account. See sample scale factor calculation on page 4-15.</p> <ul style="list-style-type: none">• To reset the Scale factor to the default value 1.0, press to enable Reset to 1.0.• To make all of the channels have the same scale factors as Channel A current and voltage, press Set Same as Channel A. The display will change to show only one scale factor value for all channels. Press the scale factor window to enter the CT scale factor on the current probe.• Press the corresponding Scale Channel/Parameter to show the numeric window to enter the CT scale factor on the current probe.• Pressing Exit will return the Auto Setup page.	

Section C

Wizard Setup

Overview

Introduction

Wizard Setup guides you through the circuit setup step-by-step, via a series of screens prompting for information about the circuit to be monitored. The instrument automatically turns on the correct channels, sets the parameter thresholds and waveform capture settings depending on the detected circuit type, nominal voltage and current values, and monitoring mode specified. The user can then modify these settings if necessary.

Monitoring modes

HDPQ Xplorer allows you to monitor events in the following setup categories: Standard Power Quality, Current Inrush, Fault Recorder, Energy & Demand Audits, Long-term Timed Recording, Continuous Data Logging, EN50160 Power Quality, and Motor Quality mode. Selecting any setup category automatically sets trigger and capture conditions. Advanced users are free to mix and match settings.

Standard Power Quality, Demand, Energy: HDPQ Xplorer algorithms automatically evaluate existing rms and waveform conditions to optimize setups to reliably capture data. This feature ensures that the first-time user gets the expected results, while providing the experienced user with the ability to tweak settings for specific applications. Either way, the necessary data used to identify critical events and optimize mitigation solutions is recorded into the memory as it occurs.

Current Inrush: Determining system characteristics during current inrush conditions such as impedance changes during motor energization or the I^2t curve of a breaker trip is key to preventative maintenance and enhanced power system performance. Inrush-type events such as motor start-up typically requires extended duration cycle-by-cycle recording. With HDPQ Xplorer, you can capture and store detailed data to evaluate system performance against specifications and previous benchmark data. Under the current inrush mode, triggers are current-based. By operating in the inrush mode, the instrument will capture and store highly detailed data to memory in real time, then re-arm and be ready to capture data during the next test run.

Fault Recorder: A fault in a wire circuit is usually due to unintentional grounding, a break in the line, a crossing or shorting of the wires, etc. A digital fault recorder logs extended duration cycle-by-cycle recording. Under the fault recorder mode, triggers are voltage-based. HDPQ Xplorer can help locate failures detected in various components of assorted equipment by recording an extended period of cycle-by-cycle data to capture the entire duration of the fault and the associated system response.

Continued on next page

Monitoring modes (continued)

Energy & Demand Audits: This setup can be used to conduct complete demand and energy audit of a facility, a distribution circuit or a single piece of equipment. It can monitor demand and energy parameters for energy audits, efficiency studies and cost reduction programs. It can also be used to carry out long-term statistical studies to establish baselines and perform field-based equipment testing and evaluation for commissioning and maintenance.

Long-term Timed Recording, Demand, Energy: Performing a statistically valid power quality energy survey requires the capture of a set of basic data over an extended period of time. HDPQ Xplorer is designed to facilitate long-term monitoring by collecting min/max/avg data at each predetermined interval in order to perform post-process harmonic and other events analysis. HDPQ Xplorer is also designed to be left unattended in the field, recording statistically representative data for long-term analysis. Using the Dranetz lockable portable case option or other available enclosures, power quality studies can be carried out in harsh weather environments.

Continuous Data Logging, Demand, Energy: This logs the rms and power values once per second for totally gapless logging. Cyclic triggers are disabled. No waveforms are recorded under this monitoring mode.

Voltage Compliance (EN50160 Power Quality): Voltage Compliance monitors and reports Quality of Supply (QOS) compliance as specified by the EN standard. The seven parameters required by EN50160 to determine QOS compliance are: Power Frequency, Supply Voltage Variations, Rapid Voltage Changes, Supply Voltage Unbalance, Harmonic Voltage, Interharmonic Voltage, and Mains Signalling. Other standards can be utilized by changing appropriate setup or parameters.

Motor Quality: Automatically sets up the parameters that affect the operation of motors. Motor parameters include True Power Factor, Horsepower, and Derating Factor, among others.

Wizard setup Follow these steps to set up the circuits via Wizard Setup.

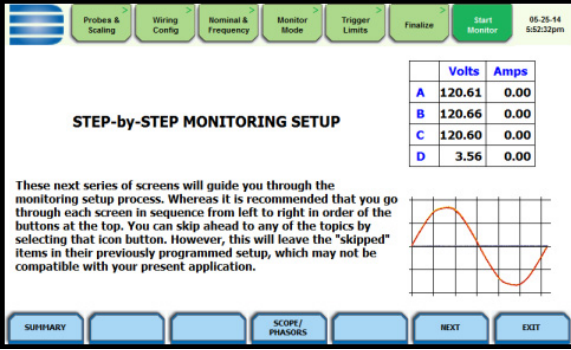
Action...	Result...
<p>STEP 1: From the Start Menu, press Wizard Setup.</p> <p>Menu Tab You can go through the monitoring setup step-by-step by clicking on the Next function key or you can skip ahead and select the menu tab on top of the screen that you want to change/view. Note that any setup menu you skip remains configured using the auto-programmed or previous settings which may not be compatible with your present application. Or if you return to a menu with an existing setup and then skip ahead, all menu settings, which may have been modified from the initial setup, will remain.</p> <p>Function Keys Use the function keys located at the bottom of screen:</p> <ul style="list-style-type: none"> • To view details of setup/parameter settings, press Summary. • To toggle between Scope and Phasor display at the bottom right corner of the screen, press Scope/Phasors. Scope shows real-time waveforms of voltage and current for the enabled channels. Phasor shows voltage and current phasor diagrams for all enabled channels. • To proceed through setup monitoring in sequence, press Next. This will open the same window as the Probes Scaling menu tab on top. See page 4-14. 	 <p style="text-align: right;">HDPQ-408</p>

Continued on next page

**Wizard setup
(continued)**

Action...	Result...
<ul style="list-style-type: none"> Pressing Exit will prompt the Exit Setup screen where you can either accept the setup changes (proceed with monitoring) or not. You can also use the instrument as a meter, retaining setup changes without turning monitoring on. 	

In this section

The following topics are covered in this section.

Topic	See Page
Current Probes - Turns Ratios Setup	4-14
Circuit Type Selection	4-17
Nominal Values	4-18
Monitoring Mode	4-21
Trigger Limits Setup Options	4-22
RMS Variation	4-23
Transients	4-27
Set Peak Transients	4-28
Set Waveshape Transients	4-30
Set RMS Distortion	4-31
Set High Frequency Transients	4-32
Waveform Capture	4-33
Timed Intervals	4-35
Journal Limits	4-38
Voltage Compliance EN50160 (for strict EN50160 Monitoring)	4-44
Finalize Monitoring	4-46
Exit Setup	4-48

Current Probes - Turns Ratios Setup

Select current probe

Follow these steps to monitor current and select probe type.

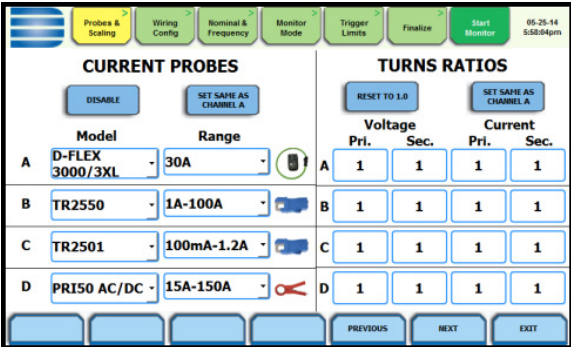
Action...	Result...
<p>STEP 1: Press the Probes Scaling tab, or from the Wizard Setup screen press Next. The Current Probes - Turns Ratios window is displayed.</p> <ul style="list-style-type: none"> • If current will not be monitored, press the Wiring Config menu tab or press Next. Go to page 4-17. • If current will be monitored, press the corresponding Probe Channel/Parameter window to display the probe types available for each channel. • If you want to enable or disable current channels, press Enable or Disable respectively. • If you want to make all channels have the same setup as Channel A current, press Set Same as Channel A. The display will change to show only one probe selection for all channels. Press the window drop down arrow to display the probe types available. • Range corresponds to the detected input range for each channel. The instrument registers the detected range for voltage and current channels A, B, C, and D. • If the current probe that you are using is not on the list, select Other. Proceed to define the CT scale factor on the current probe. Go to page 4-15. 	 <p style="text-align: right;">HDPQ-409</p>

Other relevant information on current probes

Refer to Chapter 2 Voltage Measurement Cable and Current Probe Connections for illustrations of typical current probes and for guidelines on how to connect current probes.

Refer to Appendix A for descriptions and part numbers of probes and adapter cables. Refer to Appendix B for Dranetz current probes technical specifications.

What is a scale factor?

A scale factor is the ratio of the input to output for a particular current transformer (CT) or potential transformer (PT). A scale factor is entered in HDPQ Xplorer and then multiplied automatically by the measured voltage or current so the unit displays the correct values, as referenced to the primary side, rather than the secondary side of the PT or CT (for CTs that are used in addition to those set up in the current probe menu).

NOTE: If voltage and current connections are made without using any of the above named devices, the scale factor should be set to 1.

When to use

Scale factors must be entered for the following conditions:

- A Dranetz current probe is connected to a permanently installed CT.
 - The voltage connections are made using a PT.
-

Non-Dranetz equipment

Refer to the CT name plate or to the manufacturer's literature to determine the scale factor.

Sample calculation

The scale factor for a single CT or PT is calculated from its step-up or step-down ratio.

Example of step-down ratio

If a current transformer has a step-down ratio of 1000A:5A, therefore:

$$\text{Scale Factor} = 1000/5 = 200$$

Example of step-up ratio

If a potential transformer has a step-up ratio of 1V:10V, therefore:

$$\text{Scale Factor} = 1/10 = 0.1$$

Scale factor setup

After setting up the current probe, define the Turns Ratios using the same screen.

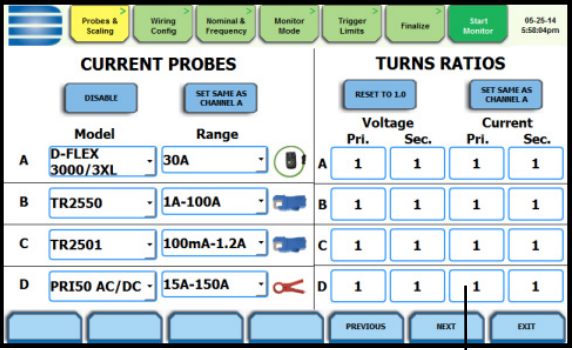
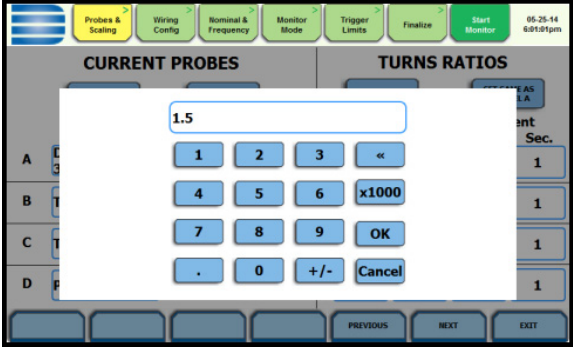
Action...	Result...
<p>STEP 1: The Current Scale Factor properties are shown on the right side of the Probe setup screen. You need to set the current turns ratios when using a current probe that is not on the list.</p> <ul style="list-style-type: none"> To reset the Turns Ratios to the default value 1.0, press to enable Reset to 1.0. To make all of the channels have the same turns ratios as Channel A current and voltage, press Set Same as Channel A. The display will change to show only one scale factor value for all channels. Press the scale factor window to enter the current scale factor on the current probe. Press the corresponding Scale Channel/Parameter to show the numeric window to enter the current scale factor on the current probe. To return to the Wizard Setup screen, press Previous. To proceed to the Wiring Config screen, press Next. Pressing Exit will prompt the Exit Setup screen where you can either accept the setup changes (proceed with monitoring) or not. You can also use the instrument as a meter, retaining setup changes without turning monitoring on. 	 <p>HDPQ-409</p>  <p>HDPQ-409b</p>

Circuit Type Selection

Circuit setup

HDPQ Xplorer is able to display wiring diagrams from which you can select the circuit type appropriate to your application. The instrument will automatically select and display the detected circuit type when entering the screen and compare the detected voltages, currents, and phase sequence (if applicable) to the selected circuit type. Refer to Appendix E for the descriptions of common circuit connections.

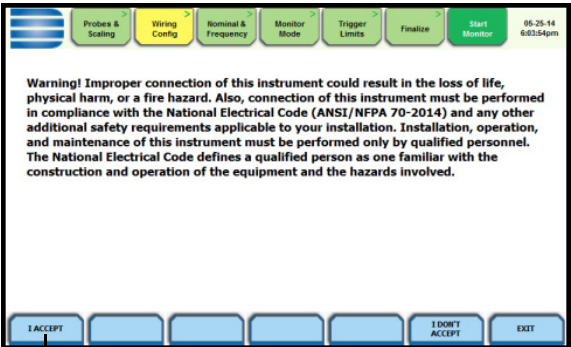
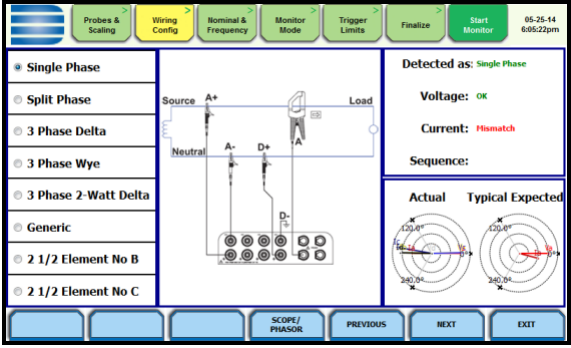
Action...	Result...
<p>STEP 1: Press the Wiring Config tab, or from the Current Probes - Turns Ratios screen press Next.</p> <p>Read the Warning advisory, then press I Accept to display the menu for circuit selection.</p> <p>An auto circuit detection window is displayed to select the detected circuit type, nominal voltage, current and frequency. Parameters that match expected measurements are displayed in green. Ones that do not match are displayed in red.</p> <ul style="list-style-type: none"> To select a circuit type, press the radio button of your desired circuit configuration. The typical phasor display based on the circuit type selected is shown at the bottom right corner of the screen. To toggle between the actual Scope and Phasor display, press Scope/Phasor. Scope shows real-time waveforms of voltage and current for the enabled channels. Phasor shows voltage and current phasor diagrams for all enabled channels. To return to the Probes Scaling screen, press Previous. To proceed to the Nominal Frequency screen, press Next. Pressing Exit will prompt the Exit Setup screen where you can either accept the setup changes (proceed with monitoring) or not. You can also use the instrument as a meter, retaining setup changes without turning monitoring on. 	 <p>HDPQ-410</p>  <p>HDPQ-411</p>

Nominal Values

Frequency, voltage and current settings

The Nominal Values screen allows you to select frequency synch options, including channel source (Va, Vd, Ia, Id), speed of response (Standard - Utility Power Line, Fast - Local Generator or Internal), and frequency sync min/max range.

Action...	Result...
<p>STEP 1: Press the Nominal & Frequency tab or from the Wiring Config screen, press Next. Nominal values appear as you prepare the instrument to record data.</p> <ul style="list-style-type: none"> • If the computed nominal values are acceptable without change, press the Monitor Mode tab or press Next. Go to page 4-21. • To set the parameters to track frequency of a monitored system, check the following: <p><u>Nominal Values</u></p> <ul style="list-style-type: none"> • To enter a new internal Frequency, Voltage, Current and/or Max Demand Current value, press the corresponding field and enter a new value using the numeric keypad. <p>NOTE 1: Always enter a nominal frequency that matches your line frequency. This ensures that if external sync is lost, there will be a corresponding internal sync.</p> <p>NOTE 2: Max Demand Current is used to calculate Total Demand Distortion (TDD). Unless this value is set by the user, it will default to the value of nominal Probe Range.</p> <p><u>Profile</u></p> <p>This is the tracking rate of the PLL circuitry to changes in frequency.</p> <ul style="list-style-type: none"> • Standard (Utility Power Line) is a slow 0.01 Hz per second rate of change response. 	<p>The screenshot shows the 'Verify Computed Values' screen. At the top, there are tabs for 'Probes & Scaling', 'Wiring Config', 'Nominal & Frequency', 'Monitor Mode', 'Trigger Limits', 'Finalize', and 'Start Monitor'. The 'Nominal & Frequency' tab is active. Below the tabs, the screen is divided into two main sections. The left section, titled 'Verify Computed Values', contains a text block explaining that the computed nominal values for frequency, voltage, and current are shown on the screen and will be used as the basis for setting default thresholds. Below this text are four input fields: 'Frequency' (60.00 Hz), 'Voltage' (120.00 Vrms), 'Current' (2.33 Irms), and 'Max.Dmd Current' (20.00 Irms). The right section, titled 'Advanced Frequency Tracking', contains a 'Profile' section with three radio button options: 'Standard (Utility Power Line)' (selected), 'Fast (Local Generator)', and 'Internal'. Below the profile section is a 'Sync Channel' section with three radio button options: 'Channel A Volts' (selected), 'Channel D Volts', and 'Channel A Amps'. To the right of the 'Sync Channel' section is a 'Tracking Range' section with two input fields: 'Min' (50.90) and 'Max' (69.10). At the bottom of the screen, there are four buttons: 'PREVIOUS', 'NEXT', and 'EXIT'.</p> <p>NOTE: Make sure that the nominal values computed by HDPQ Xplorer are correct. Nominal values are used as basis for setting default thresholds and other parameters for circuit monitoring.</p>

Continued on next page

**Frequency,
voltage and
current settings
(continued)**

Action...	Result...
<ul style="list-style-type: none"> • Fast (Local Generator) is a 0.1 Hz per second rate of change response. • Internal uses the nominal frequency when making measurements where no reference signal is available. <p><u>Sync Channel</u> Check to specify the external sync mode to show which channel the signal is connected to.</p> <ul style="list-style-type: none"> • Channel A Volts/Amps: When set to Ch A, HDPQ Xplorer attempts to sync to an incoming voltage/current signal. • Channel D Volts/Amps: When set to Ch D, HDPQ Xplorer only attempts to sync to voltage/current Ch D. This is useful when the other voltage/current channels are either very noisy or PWM (pulse width modulation) waveforms, such as with some types of adjustable speed drives. <p><u>Tracking Range</u> The Min and Max refer to the range of frequencies that the phase locked loop will “hunt” if sync is lost.</p> <ul style="list-style-type: none"> • To change the minimum frequency for PLL to synch to, press the Min window and enter a numerical entry in the pop-up window. • To change the maximum frequency for PLL to synch to, press the Max window and enter a numerical entry in the pop-up window. <p>See page 4-20 for more details on frequency tracking.</p>	

Frequency synchronization

Normal frequency synchronization (sync) of HDPQ Xplorer analog signal processing circuits is controlled by analyzing the external AC voltage signal input on CH A (or CH D according to setup). Loss of external sync causes the HDPQ Xplorer to hold the last valid frequency for the synch channel until adequate frequency returns. If none exists, then internal sync is automatically selected. The frequency used for internal is entered under Frequency on the Nominals screen.

NOTE: Failure to connect an external sync or to select an internal sync during current monitoring will result in erroneous data being collected and displayed.

Frequency tracking

Tracking determines how the phase locked loop circuitry responds to sudden changes in frequency.

Standard mode: On a normal power quality application [Standard], the system is designed to “ride through” voltage changes to keep steady the fundamental frequency in the absence of voltage, or to track slow changes of frequency as the generators are adjusted by system operators.

Fast mode: When operating on a local or backup generator [Fast], the frequency will vary more as loading changes occur. The Fast mode allows the instrument to follow these changes more closely.

Internal mode: In cases where no reference signal is available (such as DC monitoring), the Internal setting is used to set the sample rate.

Monitoring Mode

Choose a monitoring mode

HDPQ Xplorer provides nine monitoring modes of operation from which to monitor and capture data relevant to the user application.

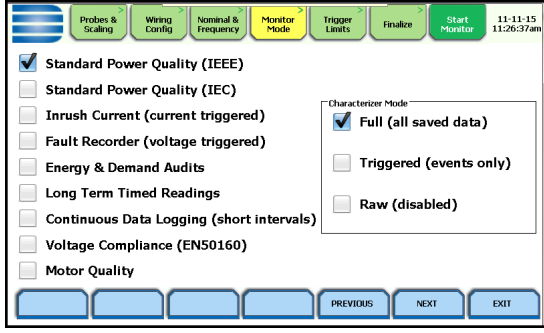
Action...	Result...
<p>STEP 1: Press the Monitor Mode tab or from the Nominal & Frequency screen, press Next.</p> <ul style="list-style-type: none"> The different monitoring mode setups are displayed. Check to select the desired monitoring mode, then press the Trigger Limits tab or press Next. To return to the Nominal Values screen, press Previous. Pressing Exit will prompt the Exit Setup screen where you can either accept the setup changes (proceed with monitoring) or not. You can also use the instrument as a meter, retaining setup changes without turning monitoring on. 	 <p>NOTE: The captured data will be characterized according to the measurement criteria selected under the Characterizer Mode.</p> <p>Full (all saved data) - check this to characterize all data saved, in compliance with the criteria set by IEEE 1159 or IEC 61000-4-30 Class A.</p> <p>Triggered (events only) - check this to characterize event data only, in compliance with the criteria set by IEEE 1159 or IEC 61000-4-30 Class A.</p> <p>Raw (disabled) - check this for no characterization associated with the captured data.</p>

Setup mode descriptions

Standard Power Quality (IEEE/IEC) optimizes the instrument to collect data for troubleshooting using standard power quality parameters, with numerous trigger conditions set. The threshold for an interruption in IEEE Std 1159 is 10% of nominal while in IEC 61000-4-30 it is 1% of nominal.

Inrush Current is ideal for recording motor start-up and inrush conditions. This setting is used when recording is triggered on change in current with longer cycle-by-cycle waveform capture than Standard Power Quality.

Fault Recorder is similar to Inrush but with a voltage trigger.

Energy & Demand Audits monitor demand and energy parameters for energy audits, efficiency studies and cost reduction programs.

Long-term Timed Readings (long time recordings) set the instrument to use periodic measurements only. This setting is used for long-term statistical studies and benchmarking field-based equipment testing and evaluation. No triggers are set so only trended values are available.

Continuous Data Logging (short intervals) sets the instrument to log rms and power values once per x seconds until memory is filled or for specified time period.

Voltage Compliance (EN50160) monitors and reports Quality of Supply (QOS) compliance as specified by the EN50160 standard.

Motor Quality sets up the parameters that affect the operation of motors.

NOTE

You can override the default settings in any of the above monitoring modes to customize the instrument to your application.

Trigger Limits Setup Options

Limits setup options

After selecting a monitoring mode, the system is now ready to begin monitoring and to record data in memory. Prior to actual monitoring, you have the option to accept the default threshold settings and proceed with monitoring, or to review and/or modify monitoring settings.

Limits list the threshold parameters available for review or modification. Experienced users are able to customize threshold settings according to their applications. They can turn on or off any available parameters and enter new threshold limits, as required.

After selecting a monitoring mode, press the Trigger Limits tab or press Next. The Limits screen will vary according to the selected monitoring mode.

Trigger Limits for all Monitoring Modes Except Voltage Compliance (EN50160):

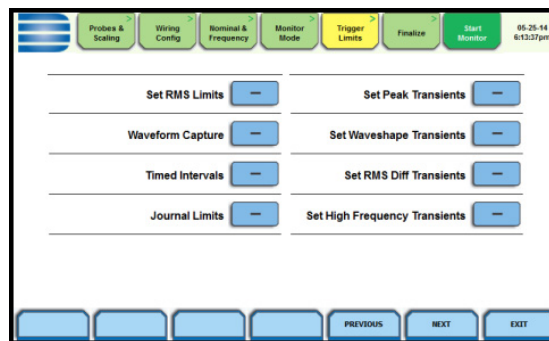

- To review/modify limits for rms variation, press Set RMS Limits. Go to page 4-23.
- To review/modify limits for transient events, press:
 - Set Peak Transients - to set instantaneous limits (p. 4-28)
 - Set Waveshape Transients - to set waveshape threshold duration (p. 4-30)
 - Set RMS Diff Transients - to set the rms distortion waveshape limit (p. 4-31)
 - Set High Frequency Transients - to set high frequency transient detectors (p. 4-32)
- To review/modify trigger channels, press Waveform Capture. Go to page 4-33.
- To review/modify journal interval setups, press Timed Intervals. Go to page 4-35.
- To review/modify journal limit settings, press Journal Limits. Go to page 4-38.

Monitoring Mode for Voltage Compliance (EN50160):

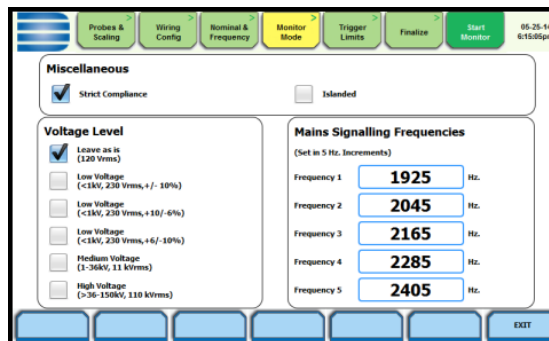

- To review/modify limits for EN50160 Monitoring. Go to page 4-44.

If the default settings for the specified monitoring mode are acceptable, proceed to the next tab Finalize (if there is nothing else to change). Go to page 4-46.

RMS Variation

RMS variation setup properties RMS stands for root mean square, a mathematical formula used to compute the equivalent value of the voltage and current. Voltage and current changes are measured and checked against the programmed limits. Thresholds are set as high limits (threshold above the programmed limit) and low limits (threshold below the programmed limit). RMS variations result whenever voltage or current rms value rise above or fall below the programmed threshold limits. The limits determine how sensitive the instrument should be. Note that statistical and trending information is always captured regardless of the limit settings, so you will never be without a data even if limits are not set to the ideal values.

HDPQ Xplorer allows you to set the limits for each of the triggers, as well as the amount of rms value (in cycles) to record before and after the trigger cycle.

RMS trigger parameters In order for the instrument to trigger on rms variation, any of the enabled and programmed voltage and/or current channel must go above the High Limit or below the Low Limit for a period of at least one rms value (which are computed twice per cycle with a one cycle sliding integration window).

The aggregated disturbance end point is defined as the cycle when all channels of the same type (voltage or current) for which triggers are enabled have come back within limits (plus hysteresis) for a minimum duration of cycle. Until this criteria is met, any subsequent excursions beyond the thresholds are considered part of the original disturbance. To minimize the number of triggers recorded for a sequence of closely spaced disturbances, hysteresis is employed in voltage thresholds.

NOTE: Hysteresis values assigned to limits are set by the system and not programmable.

Procedure to record rms variation

The following parameters are required to define how an rms variation is triggered:

- Low Limit
- High Limit
- Very Low Limit

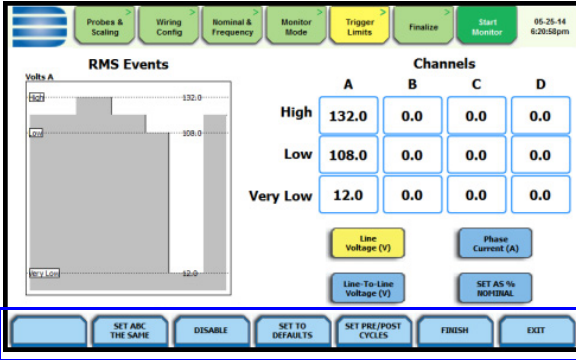
Action...	Result...
<p>STEP 1: From the Trigger Limits Setup Options screen, press Set RMS Limits. You can always return to the limits setup option screen by pressing the Trigger Limits tab.</p> <ul style="list-style-type: none"> • Use the threshold parameters High, Low, Very Low to change/enable or disable threshold values. • Use function key Set As % Nominal to display the base unit for entering thresholds. To enter limits in % of nominal, check the % of nominal checkbox. If unchecked, limits are entered in absolute values. <p><u>Function keys common to all rms and transient event setup screens:</u></p> <ul style="list-style-type: none"> • Use function key Set ABC the Same to set identical threshold values for Channels A, B and C. • Use function key Disable to deactivate a selected limit field. Make sure to Enable the field after. • Set to Defaults - restores the trigger channel settings to default values. • Set Pre/Post Cycles - defines the number of rms and waveform cycles to be saved. Proceed to Step 2. • Finish - accepts the changes made and brings you back to the limits setup options screen. • Exit - prompts the Exit Setup screen where you can either Accept or Abort the monitoring setups. Go to page 4-48. 	 <p style="text-align: right;">HDPQ-414</p> <p>Functions keys common to all rms and transient event setup screens - refer to definitions provided at left</p>

Procedure to record rms variation (continued)

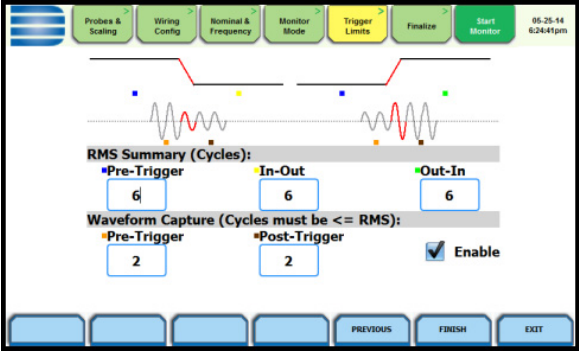
Action...	Result...
<p>STEP 2: You can define the number of rms summary and waveform cycles to be saved before the start (pre-), after the start (post-start), and after the end (post-end) of the event.</p> <p>The Pre- and Post- trigger settings under Waveform Capture (Cycles) specify the number of waveform cycles to record before, during, and after the event. Although waveform cycle recording is enabled by default, you have the option not to record waveform cycles. You can check/uncheck the Enable waveform capture box to turn waveform cycle recording on/off.</p> <p>Press any Pre- or Post- trigger cycle field. Use the numeric keypad to enter the cycle counts for corresponding rms sample/ waveform cycle capture.</p> <p><u>RMS Summary (Cycles):</u></p> <ul style="list-style-type: none"> • Press Pre-Trigger to set the number of cycles for Pre-event start rms samples. This setting is also used for Pre-event end cycles. Use the keypad to enter the number of cycles of rms samples to record before the event start trigger cycle. • Press In-Out to set the number of cycles for Post-event start cycles. Use the keypad to enter the number of cycles to record after the event start cycle. • Press Out-In to set the number of cycles for Post-event end cycles. Use the keypad to enter the number of cycles to record after the event end point. 	 <p>NOTE: The rms/waveform cycles are color-coded as plotted on screen.</p>

Continued on next page

Procedure to record rms variation (continued)

Action...	Result...
<p><u>Waveform Capture (Cycles):</u> These values can also be used for transient waveform capture.</p> <ul style="list-style-type: none"> • Press Pre-Trigger to set the number of cycles for Pre-event start waveform cycles. Use the keypad to enter the number of waveform cycles to be saved before the event start and event end cycles. • Press Post-Trigger to set the number of cycles for Post-event end waveform cycles. Use the keypad to enter the number of waveform cycles to be saved after the event start and event end cycles. • Previous - returns to the RMS Events setup screen. • Finish - accepts the changes made and brings you back to the limits setup options screen. • Exit - prompts the Exit Setup screen where you can either Accept or Abort the monitoring setups. Go to page 4-48. 	

NOTE

The number of pre-trigger cycles for waveform capture should be less than or equal to the number of pre-trigger cycles for rms summary. The same applies to the post-trigger cycles.

Transients

Transient detection

Dranetz instruments label rms voltage or current variations as either sags (voltage or current decreases below low limit) or swells (voltage or current increases above high limit) as per IEEE 1159. Voltage disturbances which are shorter in duration than typical sags and swells (which are usually 1/4 cycle or longer) are classified as transients. Two basic types of transients are:

1) impulsive transients characterized by very rapid changes in the magnitude of measured quantities and commonly caused by capacitors or inductors switching on line, loose wires, lightning, static, and power failures; and
2) oscillatory transients defined as a temporary, rapid changes of the waveform. HDPQ Xplorer has extensive recording capabilities for low and medium frequency transients using the following trigger mechanisms:

- RMS difference cycle-to-cycle
- Crest or Absolute peak (Instantaneous)
- Waveshape cycle-to-cycle magnitude/duration variation

RMS variations

RMS stands for root mean square, a mathematical formula used to measure the average voltage and current behaviors. RMS variations result whenever voltage or current behaviors rise above or fall below the programmed thresholds.

Absolute peak settings

The crest factor or instantaneous peak is the absolute peak sample value within one cycle. The instantaneous peak triggers on the absolute peak value of the entire waveform.

Waveform capture settings

Oscillatory transients are types of disturbances usually captured as waveshape faults. HDPQ Xplorer captures pre-trigger and post-trigger waveform cycles. The waveshape fault triggering algorithm essentially compares the samples for each cycle to the corresponding samples from the previous cycle. If the samples differ by more than the threshold tolerance for a length of time exceeding window percent of the power frequency cycle, a waveshape fault is registered. A trigger occurs when either waveshape or rms deviation rise outside the programmed thresholds. Waveshape trigger values include the magnitude and duration of the difference between the present and previous cycle.

Once a record trigger is detected, instantaneous waveform information is recorded for the prescribed voltage and current channel(s). Disturbance monitoring requires that voltage be continuously sampled, and recorded only if the signals exceed specified values. Waveshape changes are only triggerable for voltage transients as the current waveshapes are usually continually changing on a normally operating distribution system. However most types of disturbances require that current be recorded as well to help determine the source of the disturbance.

Set Peak Transients

Peak transient disturbance

HDPQ Xplorer uses four different algorithms to detect and record transients:

- Peak or Instantaneous trigger magnitude
- Waveshape threshold duration (window) and magnitude (tolerance) cycle to cycle
- Waveshape rms deviation cycle to cycle
- High frequency negative/positive peak detectors magnitude

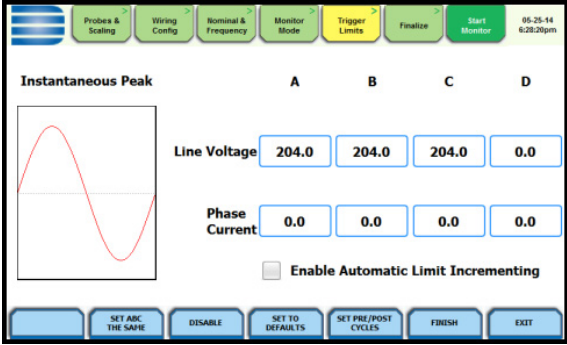
Action...	Result...
<p>STEP 1: From the Trigger Limits Setup Options screen, press Set Peak Transients.</p> <p><u>Instantaneous Peak</u></p> <ul style="list-style-type: none"> • Press the limit field to change limit. Use the keypad to enter the instantaneous limit. This value is compared against the absolute value of each scaled A/D sample of the V and I channel waveforms. • Check Enable Automatic Limit Incrementing to set limit trigger channel settings to auto-threshold mode. <p><u>Function keys common to all rms and transient event setup screens:</u></p> <ul style="list-style-type: none"> • Use function key Set ABC the Same to set identical threshold values for Channels A, B and C. • Use function key Disable to deactivate a selected limit field. Make sure to Enable the field after. • Set to Defaults - restores the trigger channel settings to default values. • Set Pre/Post Cycles - defines the number of rms and waveform cycles to be saved. Proceed to Step 2. • Finish - accepts the changes made and brings you back to the limits setup options screen. • Exit - prompts the Exit Setup screen where you can either Accept or Abort the monitoring setups. Go to page 4-48. 	 <p style="text-align: right;">HDPQ-416</p> <p>NOTE: Do not set the instantaneous peak limit value to less than or equal to the peak of the normal waveform. For a sinusoidal waveform, the peak is 1.414 x the rms value. Failure to do this will result in continuous triggering.</p>

Peak transient disturbance (continued)

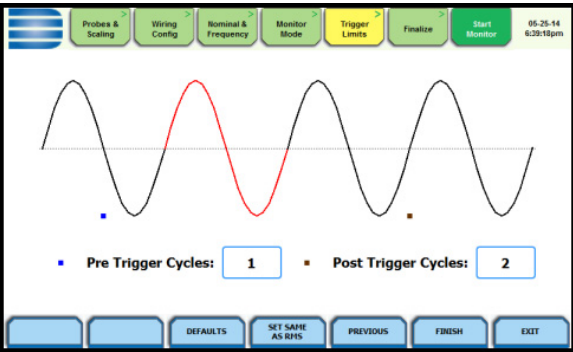
Action...	Result...
<p>STEP 2: Select how you want to specify the number of waveform cycles to record before (Pre-Trigger Cycles) and after (Post-Trigger Cycles) the trigger cycle.</p> <ul style="list-style-type: none"> Click on the Defaults key to set the waveform trigger cycle counts for transient events to the default settings: Pre-trigger cycles = 1 Post-trigger cycles = 2 Click on the Set Same as RMS key if you want to use the same waveform trigger cycle counts to capture transient events and rms events: Pre-trigger cycles = 2 Post-trigger cycles = 2 <p>NOTE: These settings apply to all three types of transient triggers (Instantaneous, Waveshape and RMS Deviation). They do not apply to High Frequency transients, where a maximum of 1 cycle of data is saved.</p> <ul style="list-style-type: none"> Previous - returns to the Instantaneous Peak screen. Finish - accepts the changes made and brings you back to the limits setup options screen. Exit - prompts the Exit Setup screen where you can either Accept or Abort the monitoring setups. Go to page 4-48. 	 <p>The screenshot shows the 'Trigger Limits' configuration screen. At the top, there is a navigation bar with buttons for 'Probes & Scaling', 'Wiring Config', 'Nominal & Frequency', 'Monitor Mode', 'Trigger Limits' (highlighted), 'Finalize', and 'Start Monitor'. The main area displays a waveform with a red peak. Below the waveform, the settings are: 'Pre Trigger Cycles: 1' and 'Post Trigger Cycles: 2'. At the bottom, there are buttons for 'DEFAULTS', 'SET SAME AS RMS', 'PREVIOUS', 'FINISH', and 'EXIT'. The screen ID 'HDPQ-417' is visible in the bottom right corner.</p>

Set Waveshape Transients

Waveshape fault detection

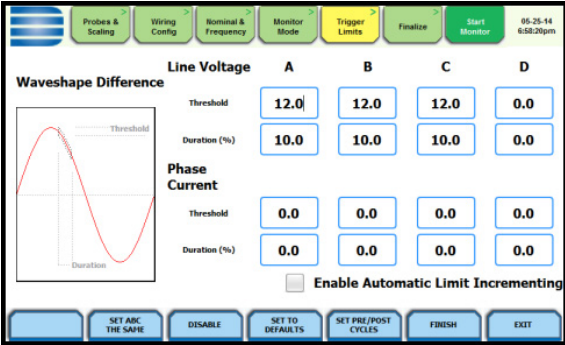
Action...	Result...
<p>STEP 1: From the Trigger Limits Setup Options screen, press Set Waveshape Transients.</p> <p>HDPQ Xplorer shows the “floating window” algorithm used for waveshape fault detection.</p> <ul style="list-style-type: none"> Press the limit field under Threshold to change limit. Use the keypad to enter the threshold limit or tolerance. If the wave samples differ by more than the threshold tolerance for a time exceeding the duration or window percent of power frequency cycle, a waveshape fault is registered. Press the limit field under Duration to change limit. Use the keypad to enter the threshold duration or window. Check Enable Automatic Limit Incrementing to set limit trigger channel settings to auto-threshold mode. <p>Common Function keys: The function keys common to the rms and transient event setup screens apply. See pages 4-28 to 4-29.</p>	 <p style="text-align: right;">HDPQ-418</p> <p>NOTE: The figure above helps illustrate the “floating window” algorithm used for waveshape fault detection. This window is visualized on screen as sliding along a waveform, precisely one cycle behind the previous sample point, v_i. The height of the window defines a maximum allowable voltage deviation in magnitude. The width of the duration corresponds to a number of sample points, N. For each sample v_i, when compared to v_{i-1} cycle where the deviation in magnitude is outside the maximum allowable deviation, a counter is incremented. For each sample v_i that is within the maximum allowable deviation, the counter, if greater than 0, is decremented. If the count reaches N, a trigger occurs.</p>

Set RMS Distortion

RMS distortion waveshape limit

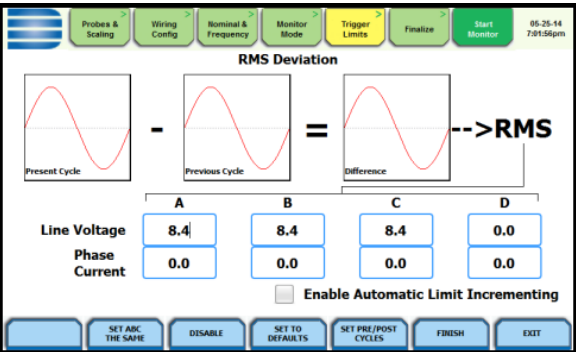
Action...	Result...
<p>STEP 1: From the Trigger Limits Setup Options screen, press Set RMS Diff Transients.</p> <p>HDPQ Xplorer allows you to set the rms distortion waveshape limit.</p> <ul style="list-style-type: none"> Press the limit field to change limit. Use the keypad to enter the treshold limit beyond which rms voltage variations occur. Check Enable Automatic Limit Incrementing to set limit trigger channel settings to auto-threshold mode. <p>Common Function keys: The function keys common to the rms and transient event setup screens apply. See pages 4-28 to 4-29.</p>	 <p>NOTE: The rms deviation algorithm subtracts the same point-on-wave sample values from previous to present cycle then calculates the rms value of the deviation over an entire cycle. If this value exceeds the threshold then a trigger occurs.</p>

Note on phase settings

Phase settings depend upon the wiring configuration or circuit type selected under Wiring Configuration. For example, for wye circuits, Line-Neutral (L-N), Neutral-Ground (N-G), and Line-Line (L-L) voltage limits can be set. For delta circuits, only L-L limits can be set.

Set High Frequency Transients

High frequency impulsive transient

High frequency detected transients uses special circuitry to detect and capture transients as small as 1 microsecond in duration. These transients can be positive and/or negative values above or below the low frequency wveshape.

Only HDPQ Xplorer and HDPQ Xplorer-400 are designed with high speed sampling analog board that can capture voltage and current transients. Because these types of disturbances usually exhibit very narrow widths and fast rise and fall times, they are quickly damped by the system. They tend to be unidirectional when close to their source.

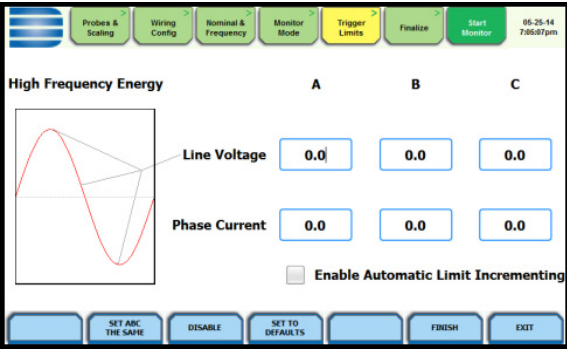
Action...	Result...
<p>STEP 1: From the Trigger Limits Setup Options screen, press Set High Frequency Transients.</p> <p>The high speed sampling analog board installed in HDPQ Xplorer enables it to detect high frequency transients.</p> <ul style="list-style-type: none"> • Press the limit field to change limit. Use the keypad to enter the high frequency limit. • Check Enable Automatic Limit Incrementing to set limit trigger channel settings to auto-threshold mode. <p>Common Function keys: The function keys common to the rms and transient event setup screens apply. See pages 4-28 to 4-29.</p> <p>NOTE: For high frequency transients, only a maximum of 1 cycle of data is saved.</p>	 <p>HDPQ-420</p> <p>NOTE: The high frequency transient detection algorithm calculates the rms energy of the waveform in an 80 usec window (not including the low frequency signal) and compares that value against the threshold to determine if a trigger occurred. If so, the prior 80 usec window, the triggered window, and three past 80 usec windows are saved. If triggers occur in every window, up to 1 cycle worth of data is saved.</p>

Waveform Capture

Trigger channel setup HDPQ Xplorer allows you to set the trigger channels/parameters for waveform capture to determine which channel's data will be saved when a trigger occurs.

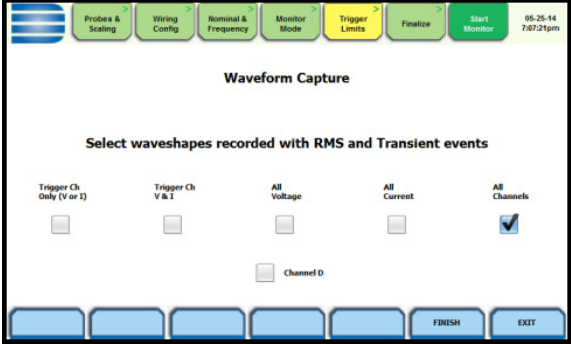
Action...	Result...
<p>STEP 1: From the Trigger Limits Setup Options screen, press Waveform Capture.</p> <p>The checked fields show the channels that will have waveforms recorded should a trigger occur. This cross-trigger function minimizes recording of meaningless data from unused (disabled) channels, as well as shows the effect that the triggered event has on other active channels that may have not triggered.</p> <ul style="list-style-type: none"> • Check/Uncheck a channel field to enable/disable selections for waveform capture. Refer to the table next page for descriptions of waveforms recorded for each trigger channel selection. • Finish - saves the changes made and brings you back to the trigger limits setup options screen. • Exit - prompts the Exit Setup screen where you can either Accept or Abort the monitoring setups. Go to page 4-48. 	 <p>HDPQ-421</p>

Trigger channel matrix The table below shows the channels that will have waveforms recorded should rms or transient triggers occur.

Trigger Type	Waveforms Recorded
If RMS or Transient event occurs	For Column 1: save waveform data for triggered channel only V or I, and Chan D if enabled
	For Column 2: save waveform data for triggered channel pair V and I, and Chan D if enabled
	For Column 3: save waveform data for all voltage channels regardless of trigger source
	For Column 4: save waveform data for all current channels regardless of trigger source
	For Column 5: save waveform data for all voltage and current channels

NOTE: For transient triggers, the same waveform recording options apply in separate settings.

Timed Intervals

Introduction

The Timed Intervals screen allows you to define how often HDPQ Xplorer saves data periodically, regardless of power quality disturbances and journal limits.

Definitions

Power Values

Power Values Interval - Power parameter values are based upon all cycles during a one second interval. Data is aggregated or summarized into min, max and avg values over the averaging period and stored at the end of the interval. Data measured include watts, power factors, as well as the one-second rms for voltage and current, which can be used instead of one cycle data. Cyclic min, max and avg are based upon full cycle waveforms with a resolution of one half (1/2) cycle for voltage and current. Note that if you did not set the thresholds for rms variations properly, the min, max and avg will still provide a record of what happened during the interval.

Waveform Snapshot- When checked, voltage and current waveforms are saved at the interval specified by the rate of V, I, W.

NOTE: When the rate is set below 30 seconds, the snapshot rate is limited to 30 seconds.

Demand and Energy

Demand Sub-Interval and *Demand Interval* - Refer to the time interval used in calculating power demand values. Demand calculations are made every sub-interval on the values that occurred during the most recent Demand Interval. Values set for Demand Sub-Interval must be an integer-divisor of the Demand Interval since the former applies when updating certain parameters of the latter.

Harmonics

Harmonics Journal Interval - Various harmonic parameters such as total harmonic distortion (THD), total interharmonic distortion (TID), and telephone influence factor (TIF) can be trended using periodic readings that are stored in the journal. Depending on the harmonic journal interval set, the instrument records a sampling of the waveform synchronized to the fundamental frequency, to ensure accurate calculation of harmonic phase angles.

Flicker

Pst (Short Term) Interval - Pst is short term perceptibility, used to set the Pst calculation interval. Typical calculation is over a 10-minute interval, though you can specify Pst Interval under Flicker.

Plt (Long Term) Interval - Plt is long term perceptibility, used to set the Plt calculation interval. Typical calculation is over a 2-hour interval, though you can specify Plt Interval under Flicker.

The Plt interval must be an integer multiple of the Pst interval. Sliding Plt recalculates the Plt value at each Pst interval, rather than only at the Plt interval.

Timed intervals menu The intervals for timed readings are user programmable.

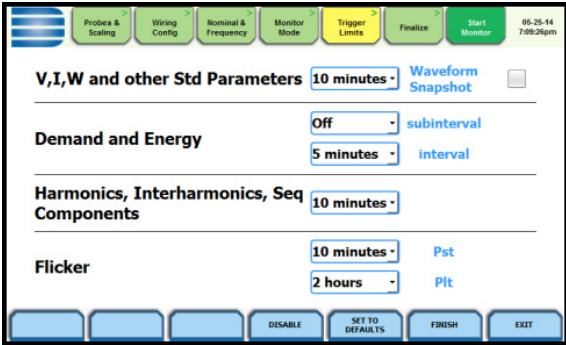
Action...	Result...
<p>STEP 1: From the Trigger Limits Setup Options screen, press Timed Intervals. The Timed Intervals menu will be displayed.</p> <p>Press the parameter that you want to change. Each time interval must be pressed repeatedly to display the available selection values.</p> <p>NOTE: Values in bold type below are the default settings.</p> <ul style="list-style-type: none"> • Selections for Power Values: <u>Power Values Interval:</u> 1 SEC, 30 SEC, 1 MIN, 5 MINS, 10 MINS, 15 MINS, 30 MINS, 1 HR, OFF <u>Waveform Snapshot:</u> Check/Uncheck box to enable/disable • Selections for Demand and Energy: <u>Demand Sub-Interval</u> (in MINUTES): 1, 5, 15, 30, OFF <u>Demand Interval</u> (in MINUTES): 1, 5, 15, 30, 60, OFF • Selections for Harmonics: <u>Harmonics Journal Interval:</u> 3 SEC, 30 SEC, 1 MIN, 5 MINS, 10 MINS, 30 MINS, 1 HR, OFF • Selections for Flicker: <u>Pst (Short Term) Interval</u> (in MINUTES): 1, 5, 10, OFF <u>Plt (Long Term) Interval:</u> 12 MINS, 1 HR, 2 HR, OFF 	 <p style="text-align: right;">HDPQ-422</p>

Continued on next page

**Timed intervals
menu
(continued)**

Action...	Result...
<ul style="list-style-type: none">• Disable - deactivates or turns all field values to Off. Pressing this key a second time will activate or turn on the field values to previous settings.• Set to Defaults - sets all field values to default settings.• Finish - saves the changes made and brings you back to the trigger limits setup options screen.• Exit - prompts the Exit Setup screen where you can either Accept or Abort the monitoring setups. Go to page 4-48.	

Journal Limits

Journal entry settings

HDPQ Xplorer allows power parameters to be trended using periodic readings that are stored in a journal. Statistical information is always captured regardless of the limit settings, so you will never be without a trend even if you did not set the limits correctly. The system collects data even when no disturbances occur by recording periodical statistical data (By Time).

Logging data by limits

Limit methods allow you to set the threshold units by which high and low limits of voltage trigger and current trigger are calculated. Thresholds are set in ranges with high limit (threshold above the normal range) and low limit (threshold below the normal range). The following threshold limits are used to trend journal parameters:

Very High: specifies the limit for comparison that is higher than the high limit

High: specifies the limit for comparison that is higher than the low limit

Low: specifies the limit for comparison that is lower than the high limit

Very Low: specifies the limit for comparison that is lower than the low limit

Deadband: specifies how much a value can change before another event is recorded

The Very high must be greater than High, Very low less than Low. Deadbands or sensitivity is used to record incremental changes in the parameter besides when limits are crossed. The hysteresis values assigned to limits are fixed and not programmable by the user. All limit values are used to determine if corresponding reporting or logging action should take place.

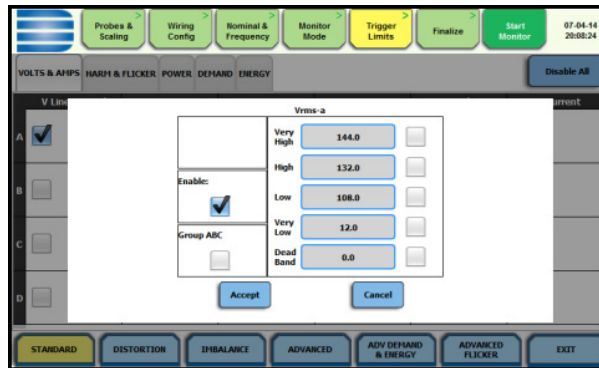

You need to Enable threshold limits to capture data. The limit fields will be activated to allow you to enter threshold values. Press the limit field (Very High, High, Low, Very Low, Dead Band) to display the numeric keypad. Use the keypad to enter the limits for the corresponding phase. When done, accept the new threshold limits for the journal entry.

Logging data by time

HDPQ Xplorer is able to measure periodic samples of the voltage and/or current waveform. The Timed Interval menu lets you set how often you want the instrument to record power parameter values, demand and energy, harmonics, flicker and others.

NOTE

You can record data simultaneously by limits and by time. Make sure to enable the parameters to trend under Journal Limits and Timed Intervals.

Journal parameter list

To review/modify journal limit setups, press the **Journal Limits** key.

The following parameters are available for recording by exception. This menu lets the user specify thresholds to force journal recording at the moment the threshold is crossed. Note only the values of the parameter are captured and not rms or waveform data. Refer to Appendix B Technical Specifications - Computed Parameters for the definition of parameters.

When pressing a cell, a menu pops-up to enable or setup limits - Very High, High, Low, Very Low, Deadband.

Standard Parameters

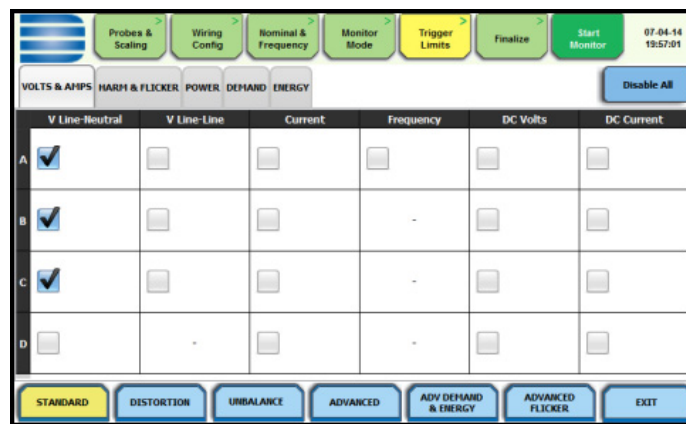

HDPQ-423

Standard				
Fx: Volts & Amps	Fx: Harm & Flicker	Fx: Power	Fx: Demand	Fx: Energy
Voltage L-N	Voltage THD	Active Power	Current Demand	Watt Hrs
Voltage L-L	Current THD	Apparent Power	Active Power Demand	VA Hrs
Current	Short Term Flicker	Fundamental Reactive Power	Apparent Power Demand	VAR Hrs
Frequency	Long Term Flicker	True Power Factor	Volts Ampere Reactive Demand	
DC Volts L-N	Slide Long Term Flicker	Displacement Power Factor		
DC Current				

Continued on next page

Journal parameter list (continued)

Distortion Parameters

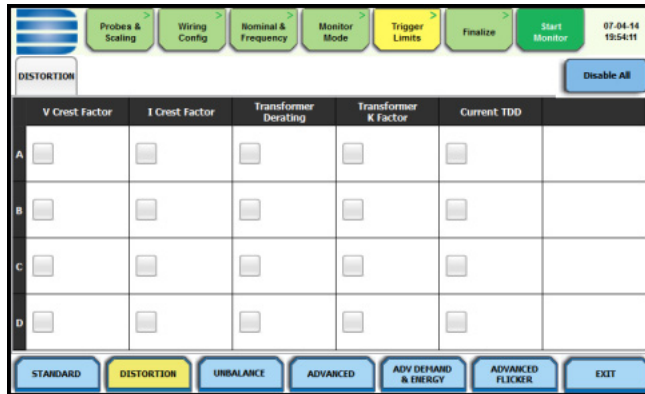

HDPQ-424

Distortion	
[Fx: none]	
Voltage Crest Factor	
Current Crest Factor	
ANSI Transformer Derating Factor	
Transformer K Factor	
Current TDD (rms)	

Unbalance Parameters

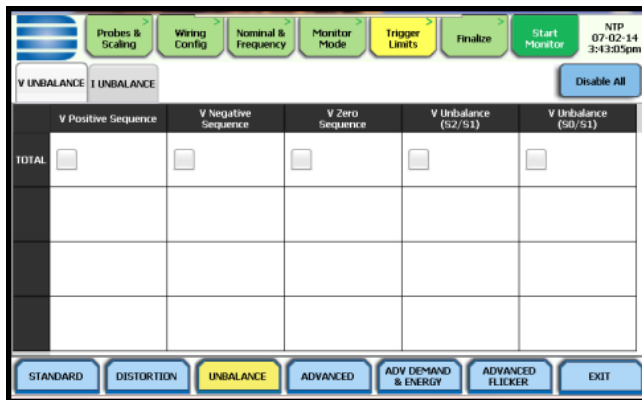

HDPQ-425

Unbalance	
Fx: V Unbalance	Fx: I Unbalance
Positive Sequence Voltage	Positive Sequence Current
Negative Sequence Voltage	Negative Sequence Current
Zero Sequence Voltage	Zero Sequence Current
V Unbalance (S2/S1)	I Unbalance (S2/S1)
V Unbalance (S0/S1)	I Unbalance (S0/S1)

**Journal
parameter list
(continued)**

Advanced Meter Parameters

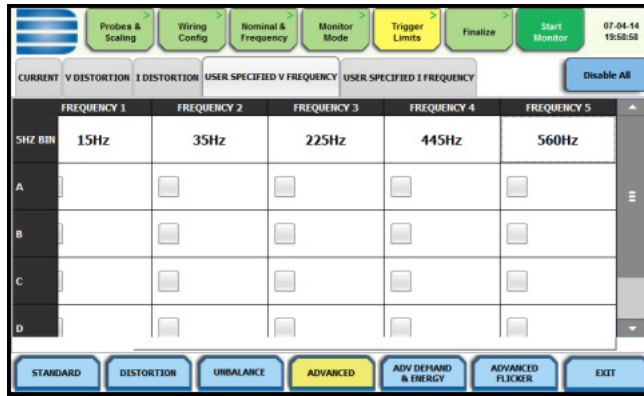

HDPQ-426

Advanced Meter				
Fx: Current	Fx: V Distortion	Fx: I Distortion	User Specified V Frequency*	User Specified I Frequency*
V/I Phase	Voltage Total Harmonic Distortion	Current Total Harmonic Distortion	User Specified 5Hz Frequency bin for Volts 1	User Specified 5Hz Frequency bin for Current 1
Residual Current	Voltage Telephone Influence Factor	Current Total Interharmonic Distortion	User Specified 5Hz Frequency bin for Volts 2	User Specified 5Hz Frequency bin for Current 2
Net Current	Voltage Total Interharmonic Distortion	RMS Current Individual Odd Harmonics	User Specified 5Hz Frequency bin for Volts 3	User Specified 5Hz Frequency bin for Current 3
	Unsigned Harmonic Power	RMS Current Individual Even Harmonics	User Specified 5Hz Frequency bin for Volts 4	User Specified 5Hz Frequency bin for Current 4
		IT Product	User Specified 5Hz Frequency bin for Volts 5	User Specified 5Hz Frequency bin for Current 5

***NOTE:** The user selected frequency bins allow you to specify up to 5 values of the 5Hz frequency signals for voltage and current to trend.

If the monitoring mode is in Voltage Compliance (EN50160), these values are equivalent to the mains signalling frequencies specified in the Voltage Compliance EN50160 screen interface (see next Section).

In all other monitoring modes, you can use this interface to specify the frequency values to trend. Note these are not the IEC grouping Harmonics or Interharmonics values.

Continued on next page

Journal parameter list (continued)

Advanced Demand & Energy Parameters

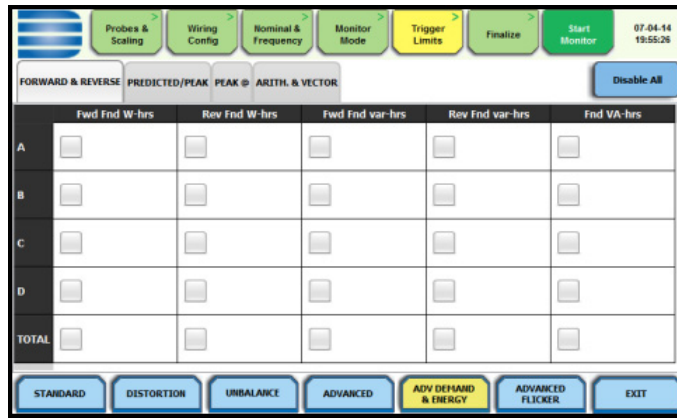

HDPQ-427

Advanced Demand & Energy					
Fx: Forward & Reverse	Fx: Predicted/ Peak	Fx: Peak @ (Peak P Demand)	Fx: Peak @ (Peak Q Demand)	Fx: Peak @ (Peak S Demand)	Fx: Arith & Vector
Forward Fund. Freq. W Hrs	Predicted P Demand	Avg PF at Peak P Demand	Avg PF at Peak Q Demand	Avg PF at Peak S Demand	Arithmetic Sum Power Factor
Reverse Fund. Freq. W Hrs	Predicted Q Demand	S Demand at Peak P Demand	P Demand at Peak Q Demand	P Demand at Peak S Demand	Arithmetic Sum Displacement Power Factor
Forward Fund. Freq. var Hrs	Predicted S Demand	Q Demand at Peak P Demand	S Demand at Peak Q Demand	Q Demand at Peak S Demand	Arithmetic Sum Volts Ampere
Reverse Fund. Freq. var Hrs	Peak Active Power Demand				Fundamental Arithmetic Sum Volts Ampere
Fund. Freq. VA Hrs.	Peak Apparent Power Demand				Vector Sum Power Factor
	Peak Reactive Power Demand				Vector Sum Displacement Power Factor
	Peak Current Demand				Vector Sum Volts Ampere
					Fundamental Vector Sum Volts Ampere

Continued on next page

**Journal
parameter list
(continued)**

Advanced Flicker Parameters

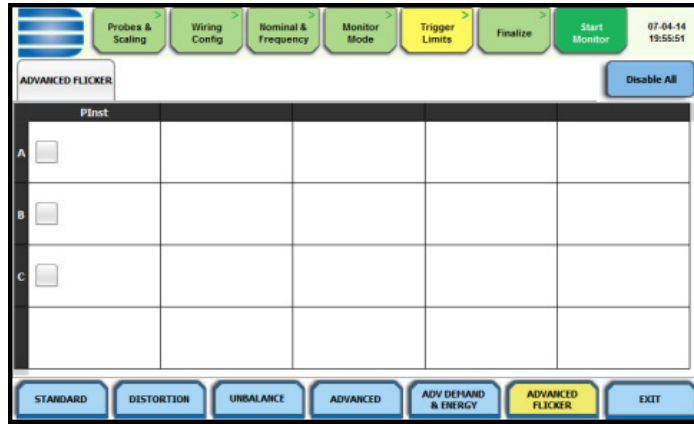

HDPQ-428

Advanced Flicker
[Fx: none]
PInst (Instantaneous Flicker)

Voltage Compliance EN50160 (for strict EN50160 Monitoring)

Setup options for EN50160

EN50160 is a statistical analysis of power quality data based on the EN (EuroNorm) standard. The statistical firmware called Quality of Supply (QOS) is built into HDPQ Xplorer, with monitoring and setup protocols set to determine voltage measurement compliance required for EN50160 monitoring. The EN50160-required measurement parameters include Power Frequency, Supply Voltage Variations, Rapid Voltage Changes, Supply Voltage Unbalance, Harmonic Voltage, Interharmonic Voltage, and Mains Signalling. The monitoring site is said to be IN COMPLIANCE if the statistical value over one (1) week for the specified parameters is 95% or greater for some parameters, 99% for others.

EN50160 setup allows you to define up to five mains signalling frequencies below 3 KHz. You can also select pre-defined values for main voltage characteristics of electricity supplied by Low Voltage (LV) and Medium Voltage (MV) public networks.

For medium voltage (MV) supply systems, a potential transformer must be used to provide a step-down ratio to reduce the high voltage of circuits above a 1000 Vrms to a level for safe measurement. Refer to connecting to a potential transformer on page E-16 for additional information.

NOTE

EN50160 is defined for the electricity supplied at the supply terminals, and does not deal with the supply system or consumer's installation or electrical equipment itself. Since the standard deals with the voltage characteristics which can be expected in public distribution networks, other aspects essential for supply quality (i.e. short circuit power) are not treated within the scope of the standard. EN50160 standard is applicable only under normal operating conditions of the supply system. Different countries use different limits for compliance, which can be set by the user if needed.

EN50160 optional settings

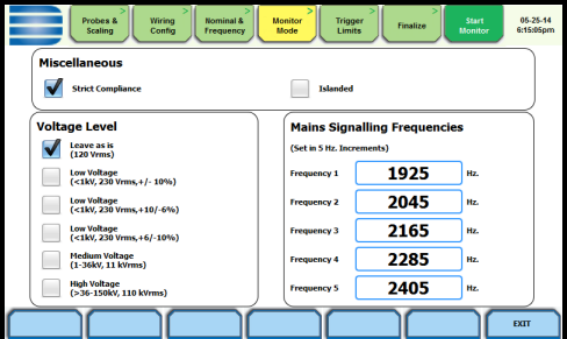
Action...	Result...
<p>STEP 1: From the Monitor Mode screen, press Voltage Compliance (EN50160).</p> <ul style="list-style-type: none"> EN50160 Strict Compliance monitoring is selected by default. Press to enable/disable miscellaneous option Islanded. Islanded means isolated from the power grid. Islanded is disabled by default, indicating that the system being monitored is synchronized to grid. 	<p>The following screen will appear if the selected monitoring mode is Voltage Compliance (EN50160):</p>  <p style="text-align: right;">HDPQ-429</p>

Continued on next page

**EN50160
optional settings
(continued)**

Action...	Result...
<ul style="list-style-type: none"> • Define up to five frequency signals set in 5Hz resolution. Mains signalling compliance or non-compliance is determined by calculating/adding the status of each of the defined frequencies. • To modify frequency settings for EN50160 monitoring, press the desired frequency field. Use the numeric keypad to enter new frequency values. • Press to select from the following EN50160 monitoring voltage level: <ul style="list-style-type: none"> Leave as is (120 Vrms) Low Voltage (230 Vrms, +/- 10%) Low Voltage (230 Vrms, +10/-6%) Low Voltage (230 Vrms, +6/-10%) Medium Voltage (11 kVrms) LV is defined as <1kV nominal. MV is 1kV to 35kV nominal. • To return to the Monitor Mode screen, press Exit. 	

Finalize Monitoring

Finalize setup

Once the instrument has been set up for monitoring or after reading a setup template from memory, you can finalize and configure the monitoring process using the parameters below.

Press the **Finalize** tab. Prior to finalizing the monitoring setup, you have the option to:

- Indicate when to start/stop recording - begin monitoring immediately or at a specified time and date
- Manage files in memory
- View the setup summary
- Enter additional information about the site that is to be saved with the setup

HDPQ-430

Start/Stop Monitoring Conditions

Under the Start monitoring options, select one from the following:

- Immediate - to begin monitoring immediately
- Delay - use the window provided to enter the number of days, hours, minutes or seconds of delay to start monitoring from present time
- Specified time and date - use the corresponding windows provided to specify the time and date when monitoring begins

Under the Stop monitoring options, select one from the following:

- Storage full - to end monitoring when memory storage is full
- Delay - use the window provided to enter the number of days, hours, minutes or seconds of delay to end monitoring
- Specified time and date - use the corresponding windows provided to specify the time and date when monitoring ends
- Never - to keep monitoring without specified end date/time

NOTE: You can manually stop monitoring using the Stop Monitoring icon.

Memory

Under Memory:

- Free Space - indicates the remaining space in memory in gigabytes
- Used Space - indicates the memory space used in gigabytes

Continued on next page

**Finalize setup
(continued)**

- **Manage Memory** - lists the recorded monitoring sessions, when events have been captured and stored in memory. Each recorded session is identified by a Session #, Name, the Date and Time range when monitoring started and ended, and the Number of Event Records contained in the particular session. The monitoring sessions are arranged in the order of date and time they were recorded.

Configuration

Under Configuration, select from the following:

- **View Summary** - use this key to display the parameter settings in effect; Setup summary is available for review before, during, and after monitoring.
- **Save** - use this key create a filename and save the Setup file template in memory.

Optional Information

Under Optional Information:

You can enter additional information about the site that is to be saved with the setup i.e. monitoring session filename, location, notes.

- To return to the Trigger Limits screen, press **Previous**.
- To accept/abort the monitoring settings, press **Next** or **Exit**. The Exit Setup screen will be displayed. See next page.

**Guidelines on
file data transfer**

HDPQ Xplorer treats the internal memory and the external memory device like a USB flash drive storing files in Windows-compatible format. For successful data transfer, keep the following points in mind:

- HDPQ Xplorer supports a maximum directory size of 4GB.
 - Both the internal memory and the external memory device allow you to store multiple files. The Site name will be used as the filename for record files (i.e. if the site name is HDPQ Xplorer, the filename will be HDPQ Xplorer 00.DDBX). A number is automatically appended to the name such that filenames are automatically incremented every time you start monitoring with that same filename.
-

Exit Setup

Exit Setup

At the end of the Wizard Setup, the **Exit Setup** screen prompts you to either accept the setup changes or not, before going on to start monitoring (if accepted). You also have the option to use the instrument as a meter, where monitoring setup changes are retained without turning monitoring on.

If you jump to the Start Monitor mode while stepping through the Wizard Setup, this screen will pop up to verify if the changes are to be accepted or not, before continuing on to start monitoring (if accepted).

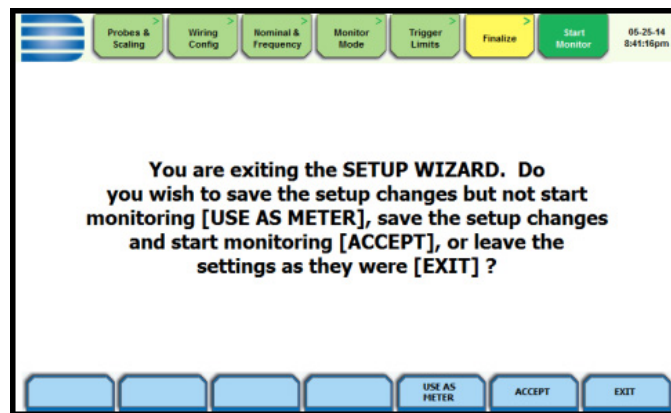

HDPQ-431

Use as Meter

Press **Use as Meter** if you want to finish the setup process (save setup changes) but DO NOT turn monitoring on.

Accept

Press **Accept** if you want to confirm changes made in monitoring settings and start monitoring.

Immediate monitoring

While the instrument is actively monitoring data, the message MONITORING STATUS: ON appears in the Monitoring Status page.

You cannot change the time and date nor perform memory device operations while the instrument is actively monitoring data. However, the rest of the function keys, including date style and clock style, are operable even while monitoring status is ON.

NOTE: You can manually stop monitoring using the Stop Monitoring icon.

End monitoring

When monitoring ends, the message MONITORING STATUS: DONE appears on screen.

Exit

Press **Exit** if you want to retain monitoring settings as they were and return to Start Menu.

Section D

Monitor Same Circuit

Overview

Introduction Menu options for monitoring become available only after setting up the instrument or from reading a setup template from memory. You can make use of existing setups for monitoring using the Monitor Same Circuit key.

Monitor same circuit Follow these steps to display the monitoring options menu.

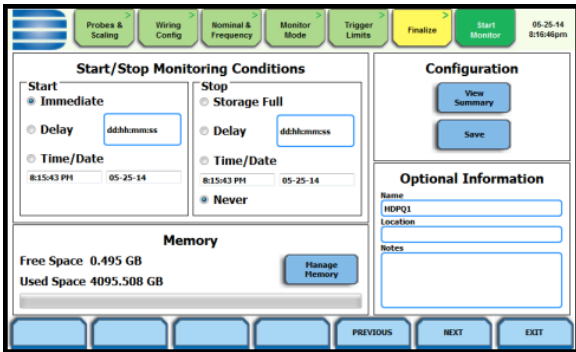
Action...	Result...
<p>STEP 1: From the Start Menu, press Monitor Same Circuit. The monitoring options menu will be displayed.</p> <p>Monitoring options allow you to begin monitoring immediately or at a specified time and date. You can also manage files in memory, view setup summary, and/or enter additional information about the site that is to be saved with the setup.</p> <p>Refer to the particular section for information on how to start/stop monitoring and how to view/save setup configuration.</p>	 <p style="text-align: right;">HDPQ-430</p>

In this section The following topics are covered in this section.

Topic	See Page
Turn Monitoring On/Off	4-50
View/Save Setup Configuration	4-54

Turn Monitoring On/Off

Start/Stop monitoring

Once the instrument has been set up for monitoring or after reading a setup template from memory, you can finalize and configure the monitoring process using the parameters on the Finalize tab.

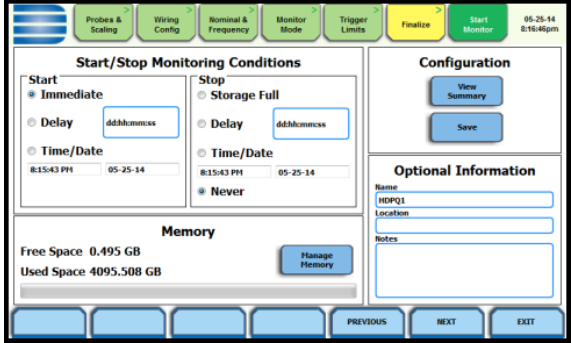
Action...	Result...
<p>STEP 1: Prior to finalizing the monitoring setup, review the selections under Finalize tab - Start/Stop Monitoring Conditions and choose the setting when you want to start/stop monitoring.</p> <p>NOTE: By default, the system is configured to start/end monitoring using the Immediate setting.</p> <p><u>Under Start monitoring options:</u></p> <ul style="list-style-type: none"> To start monitoring, select Immediate and click on the Next key. Proceed to Step 2. To delay start of monitoring, select Delay. Use the window provided to enter the number of days, hours, minutes or seconds of delay to start monitoring from present time. To start monitoring at a specified date and time, select Time/Date. Use the corresponding windows provided to specify the time and date when you want monitoring to begin. <p><u>Under Stop monitoring options:</u></p> <ul style="list-style-type: none"> To end monitoring when memory storage is full, select Storage Full. To delay end of monitoring, select Delay. Use the window provided to enter the number of days, hours, minutes or seconds of delay to end monitoring. 	 <p>The screenshot shows the 'Finalize' tab of the HDPQ-430 instrument. It is divided into three main sections: 'Start/Stop Monitoring Conditions', 'Configuration', and 'Memory'. - Start/Stop Monitoring Conditions: Under 'Start', 'Immediate' is selected. Under 'Stop', 'Storage Full' is selected. There are input fields for 'Delay' and 'Time/Date' for both start and stop conditions. - Configuration: Includes 'View Summary' and 'Save' buttons, and fields for 'Name' (HDPQ1), 'Location', and 'Notes'. - Memory: Shows 'Free Space 0.495 GB' and 'Used Space 4095.508 GB', with a 'Manage Memory' button. At the bottom, there are navigation buttons: 'PREVIOUS', 'NEXT', and 'EXIT'. The instrument ID 'HDPQ-430' is printed at the bottom right of the screenshot.</p>

Continued on next page

Start/Stop monitoring (continued)

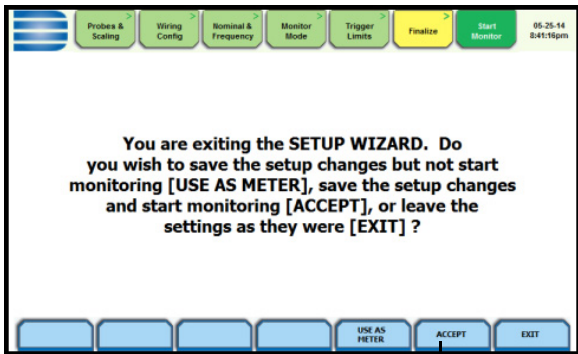
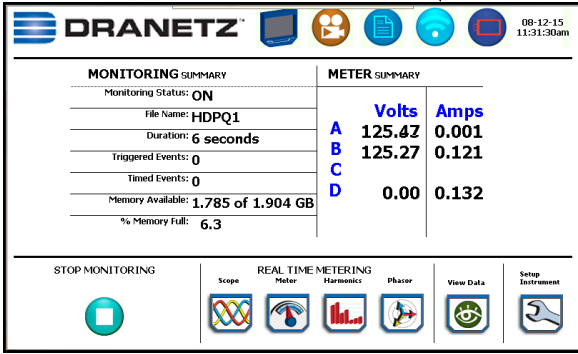
Action...	Result...																																
<p>STEP 1 (continued):</p> <ul style="list-style-type: none"> To end monitoring at a specified time and date, press Time/Date. Use the corresponding windows provided to specify the time and date when you want monitoring to end. To keep monitoring without specified end date/time, select Never. To manually end monitoring, see Step 3. <p>NOTE: Even if you select to Never end monitoring, data monitoring will end when memory is full.</p>																																	
<p>STEP 2: Prior to turning monitoring on, the Exit Setup screen prompts you to either accept the setup changes or not.</p> <ul style="list-style-type: none"> Press Accept to confirm the changes made in the monitoring settings. The Home Monitoring page will be displayed. <p>NOTE: While the instrument is actively monitoring data, the message MONITORING STATUS: ON appears in the Home Monitoring page.</p> <ul style="list-style-type: none"> Press Exit to retain previous monitoring settings and return to the Start Menu. To end monitoring, press the Stop Monitoring icon on the Home Monitoring page. Proceed to Step 3. 	 <p style="text-align: right;">HDPQ-431</p>  <p style="text-align: right;">HDPQ-432</p> <table border="1" data-bbox="852 1459 1404 1627"> <thead> <tr> <th colspan="2">MONITORING SUMMARY</th> <th colspan="2">METER SUMMARY</th> </tr> </thead> <tbody> <tr> <td colspan="2">Monitoring Status: ON</td> <td></td> <td></td> </tr> <tr> <td>File Name: HDPQ1</td> <td></td> <td>Volts</td> <td>Amps</td> </tr> <tr> <td>Duration: 6 seconds</td> <td></td> <td>A 125.42</td> <td>0.001</td> </tr> <tr> <td>Triggered Events: 0</td> <td></td> <td>B 125.27</td> <td>0.121</td> </tr> <tr> <td>Timed Events: 0</td> <td></td> <td>C</td> <td></td> </tr> <tr> <td>Memory Available: 1,785 of 1,904 GB</td> <td></td> <td>D 0.00</td> <td>0.132</td> </tr> <tr> <td>% Memory Full: 6.3</td> <td></td> <td></td> <td></td> </tr> </tbody> </table>	MONITORING SUMMARY		METER SUMMARY		Monitoring Status: ON				File Name: HDPQ1		Volts	Amps	Duration: 6 seconds		A 125.42	0.001	Triggered Events: 0		B 125.27	0.121	Timed Events: 0		C		Memory Available: 1,785 of 1,904 GB		D 0.00	0.132	% Memory Full: 6.3			
MONITORING SUMMARY		METER SUMMARY																															
Monitoring Status: ON																																	
File Name: HDPQ1		Volts	Amps																														
Duration: 6 seconds		A 125.42	0.001																														
Triggered Events: 0		B 125.27	0.121																														
Timed Events: 0		C																															
Memory Available: 1,785 of 1,904 GB		D 0.00	0.132																														
% Memory Full: 6.3																																	

Continued on next page

Start/Stop monitoring (continued)

Action...	Result...
<p>STEP 2 (continued):</p> <p>The following status messages are displayed after monitoring is turned on:</p> <p>MONITORING STATUS: ON (monitoring will continue until Stop Monitoring is pressed or when specified end time is reached or when memory is full)</p> <p>You cannot change the time and date nor perform memory card operations while the instrument is actively monitoring data. However, the rest of the function keys, including date style and clock style, are operable even while monitoring status is ON.</p> <p>FILE NAME: User specified or HDPQ Xplorer xx.dbx (where xx increments every time data is saved using the same file name)</p> <p>DURATION: length of period from the time monitoring started to the present time while monitoring is on</p> <p>TRIGGERED EVENTS: xx (counter on the number of events saved to memory; CYCLES SAVED appears instead of Events Saved if characterizer is set to None (Raw Data))</p> <p>TIMED EVENTS: xx (counter on the number of timed readings recorded)</p> <p>MEMORY AVAILABLE: (remaining free space in GB in memory device)</p> <p>% MEMORY FULL: x.xx (percentage of used space in internal memory of 4GB)</p>	

Continued on next page

Start/Stop monitoring (continued)

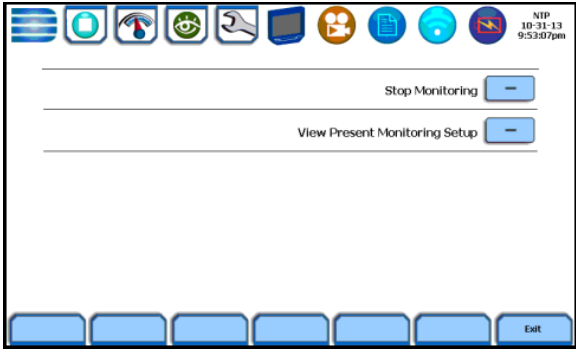
Action...	Result...
<p>STEP 3: There are three (3) ways to end monitoring:</p> <p>1st: Manually by pressing the Stop Monitoring icon once the instrument is actively monitoring on the Home Monitoring page (described below).</p> <p>2nd: Automatically when the specified end monitoring time is reached.</p> <p>3rd: When memory where data is being stored becomes full.</p> <p><u>To manually stop monitoring:</u> From the Home Monitoring page with monitoring status On, press the Stop Monitoring icon. A pop-up window confirms whether you want to end monitoring or not.</p> <ul style="list-style-type: none"> To turn monitoring off, press the Stop Monitoring key. This will save any pending data and close the file. <p>NOTE: Once monitoring ends, the message MONITORING STATUS: OFF appears on the Home Monitoring page.</p> <ul style="list-style-type: none"> To view the parameter settings in effect, press the View Present Monitoring Setup key. To continue monitoring, press Exit. The screen returns to the Home Monitoring page without changing the monitoring status. 	 <p>The screenshot shows the Home Monitoring page interface. At the top, there is a navigation bar with several icons. Below the icons, there are two main buttons: 'Stop Monitoring' and 'View Present Monitoring Setup'. At the bottom of the screen, there is a row of seven buttons, with the rightmost one labeled 'Exit'. The text 'HDPQ-433' is visible in the bottom right corner of the screenshot area.</p>

View/Save Setup Configuration

Setup configuration settings

Under Configuration settings, select one from the following.

The screenshot shows a configuration screen with the following sections:

- Start/Stop Monitoring Conditions:**
 - Start:** Immediate (selected), Delay (with input field), Time/Date (with time and date inputs).
 - Stop:** Storage Full, Delay (with input field), Time/Date (with time and date inputs), Never (selected).
- Configuration:** View Summary, Save buttons.
- Optional Information:** Name (HDPQ1), Location, Notes.
- Memory:** Free Space: 0.495 GB, Used Space: 4095.508 GB, Manage Memory button.
- Navigation:** PREVIOUS, NEXT, EXIT buttons.

HDPQ-430

View Summary - press View Summary to display the parameter settings in effect. Setup summary is available for review before, during, and after monitoring. The Setup Summary page is displayed.

The screenshot shows the 'Setup Summary' screen with the following details:

- Version: E0.17.3
- Machine S/N: HDPX0HA000
- Site Name: HDPQ1
- Circuit Type: 3 Phase Wye
- Nominal Volts: 120.00V
- Nominal Amps: 20.00A
- Nominal Frequency: 60.00Hz
- Monitoring Mode: Standard Power Quality (IEEE)
- Frequency Tracking: Standard
- Synch Input: Channel A Volts
- Tracking Frequency (Fm): 50.90Hz
- Tracking Frequency (Max): 69.10Hz
- Scale Factors:

	Volts (Pri)	Volts (Sec)	Amps (Pri)	Amps (Sec)
Channel A:	1.00	1.00	1.00	1.00
Channel B:	1.00	1.00	1.00	1.00
Channel C:	1.00	1.00	1.00	1.00
Channel D:	1.00	1.00	1.00	1.00
- Probes: Channel A: Other (LO), Channel B: Other (LO), Channel C: Other (LO), Channel D: Other (LO)
- R/S Limits: High, Low, V Low
- EXIT button at the bottom right.

HDPQ-403

- Press Up/Down arrow keys to scroll the page up or down by one line.
- Press and drag the scroll bar to move the page up or down.
- When done reviewing the Setup Summary, press Exit. The screen will return to the Finalize configurations screen.

Save - press Save if you want to save setup template files (.set) either to internal memory or to an external memory device. The Load Setup Template page appears. See next Section E Load Setup Template.

Section E

Load Setup Template

Overview

Introduction HDPQ Xplorer lets you load saved setup template files (.set) either from internal memory or from an external USB flash drive.
NOTE: Loading a setup template from memory will overwrite your existing setup.

Loading saved setups Follow these steps to load saved setups.

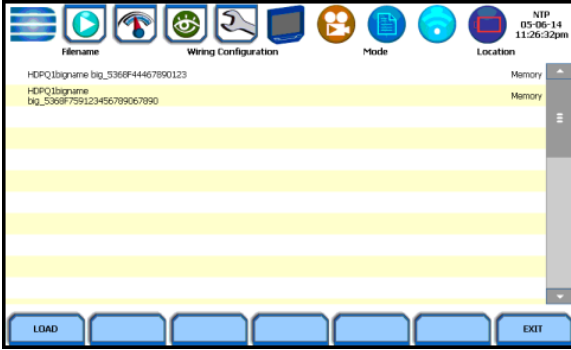
Action...	Result...
<p>STEP 1: From the Start Menu, press Load setup template. HDPQ Xplorer lists the setup template files (.set) stored in internal memory or external USB device, along with wiring configuration, setup mode application and location of file. Setup files are arranged in the order of date and time they were recorded.</p> <ul style="list-style-type: none"> • Use the scrollbar to scroll the page up or down. • Press to select (highlight) the desired setup template file. • Press Load to load setup templates from internal memory or USB into the instrument’s setup memory. Proceed to Step 2. • Press Exit to quit and return to Setup Monitoring Menu. 	
<p>STEP 2: When you load a setup data file, it will store it into the instrument’s setup memory, and becomes available to be acted on by the view data screen functions. Refer to Chapter 6 View Event Data & Reports for more information.</p>	

Section F

Load Data File from Memory

Overview

Introduction

Load Data File from Memory brings up a list of recorded monitoring sessions containing events that are saved to memory while monitoring is on. You have the ability to open a session file and view the event records contained therein, delete session files, or copy and save the files from internal memory to an external memory device.

Event data files (.ddbx) are saved to the internal memory or to an external memory device while monitoring is on. Once you load data files from memory, it will be stored directly into the instrument's event and trend memory, to be acted on by the view data screens.

Loading data from memory

Follow these steps to load data from memory.

Action...	Result...																									
<p>STEP 1: From the Start Menu, press Load data file from memory. HDPQ Xplorer lists the recorded monitoring sessions, when data has been captured and stored in memory. Each recorded session is identified by a Session #, Name, the Date and Time range when monitoring started and ended, and the Number of Event Records contained in the particular session. The monitoring sessions are arranged in the order of date/time they were recorded.</p> <p>Use the scroll bar to go through the session list and scroll the page up or down.</p> <p>Select (highlight) the desired session data file.</p> <ul style="list-style-type: none"> Press Open to bring up the Event Data & Reports menu. Proceed to Step 2. Press Close to remove data file from the instrument's event and trend memory. 	<thead> <tr> <th>Session #</th> <th>Name</th> <th>Start Date/Time</th> <th>End Date/Time</th> <th>Event Records</th> </tr> </thead> <tbody> <tr> <td>2</td> <td>inrushlap</td> <td>2014-04-12 02:50:00.00</td> <td>2014-04-30 18:35:00.00</td> <td>63809</td> </tr> <tr> <td>3</td> <td>HDPQ1</td> <td>2014-04-18 04:40:00.00</td> <td>2014-04-23 02:16:46.37</td> <td>40584</td> </tr> <tr> <td>4</td> <td>HDPQ1</td> <td>2014-04-22 02:50:00.00</td> <td>2014-04-30 08:35:51.50</td> <td>63809</td> </tr> <tr> <td>5</td> <td>HDPQ1-3</td> <td>2014-04-30 10:14:24.48</td> <td>2014-04-30 18:14:25.14</td> <td>7</td> </tr> </tbody>	Session #	Name	Start Date/Time	End Date/Time	Event Records	2	inrushlap	2014-04-12 02:50:00.00	2014-04-30 18:35:00.00	63809	3	HDPQ1	2014-04-18 04:40:00.00	2014-04-23 02:16:46.37	40584	4	HDPQ1	2014-04-22 02:50:00.00	2014-04-30 08:35:51.50	63809	5	HDPQ1-3	2014-04-30 10:14:24.48	2014-04-30 18:14:25.14	7
Session #	Name	Start Date/Time	End Date/Time	Event Records																						
2	inrushlap	2014-04-12 02:50:00.00	2014-04-30 18:35:00.00	63809																						
3	HDPQ1	2014-04-18 04:40:00.00	2014-04-23 02:16:46.37	40584																						
4	HDPQ1	2014-04-22 02:50:00.00	2014-04-30 08:35:51.50	63809																						
5	HDPQ1-3	2014-04-30 10:14:24.48	2014-04-30 18:14:25.14	7																						

| | **NOTE:** The following icons indicate the status of action you take with a particular session data file: - means data file is open for active viewing - means data file is open for active monitoring - means data file is being archived or copied to a USB flash drive - means data file is being deleted from memory |

Continued on next page

Loading data from memory (continued)

Action...	Result...
<ul style="list-style-type: none"> • Press Delete to clear the selected (highlighted) session data file in the list. This will remove the selected file from memory. • Press Delete All to clear all session data files in the list. This will remove all data files from memory. <p>NOTE: All data files stored in event memory will be lost when you press Delete All. Copy any files that you want to save to a computer or USB flash drive first before deleting all files.</p> <ul style="list-style-type: none"> • Press Archive to USB to copy and save data files from internal memory to an external USB device. Once the files have been saved, you will need the Dranetz Dran-View[®] program to retrieve and view the files in your computer. • Press Archive Locally to save data files locally into the instrument's internal memory. • Press Exit to return to Start menu. 	<p>NOTE: When saving files to USB: If the data file is open for active viewing, you have to close the file first in order to archive or save the file to the USB flash drive.</p> <p>If the data file is open for active monitoring, you have to first press stop monitoring, then view the setup session file. Once the setup file has been successfully recorded and events captured and stored in memory, you can proceed to archive or save the file to USB flash drive.</p>
<p>STEP 2: Once you open a session data file, it will load and store it into the instrument's event and trend memory, and becomes available to be acted on by the view data screen functions. Refer to Chapter 6 View Event Data & Reports for more information.</p>	 <p style="text-align: right;">HDPQ-436</p>

Section G

Change Instrument Configuration

Overview

Introduction

HDPQ Xplorer allows you to manage the instrument to make sure that it runs efficiently, and the instrument is set up according to your preferences and application. From the Start Menu, select Change Instrument Configuration to display the Instrument Settings menu.

Instrument configuration

Follow these steps to access the instrument configuration menu.

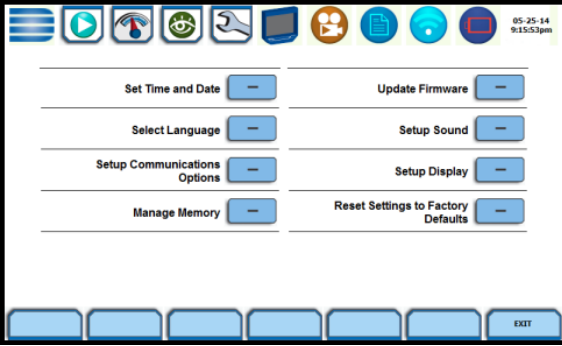
Action...	Result...
<p>STEP 1: From the Start Menu, press Change Instrument Configuration. The Instrument Settings menu will be displayed.</p> <p>You can configure the instrument to set up the following:</p> <ul style="list-style-type: none"> • time and date display • language selection • communications options • manage files in memory • firmware update • trigger alarm setup • setup display • factory default settings <p>Each of these functions is discussed in Chapter 5 Instrument Settings.</p>	 <p style="text-align: right;">HDPQ-501</p>

Section H

View/Save Monitoring Setup

Overview

Introduction

The setup summary displays the list of parameter settings for the present setup application. Setup summary is available for review before, during and after monitoring. You have the ability to save the monitoring settings to internal memory or to an external USB flash drive.

View/Save setups

Follow these steps to view or save the present setups.

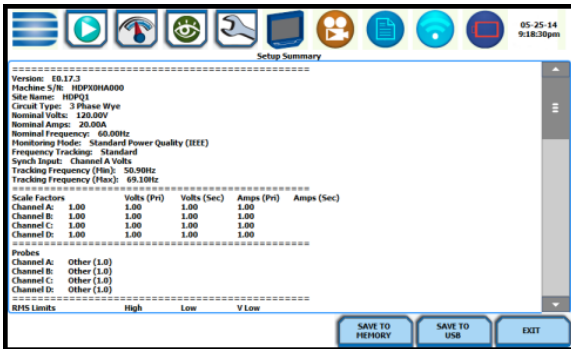
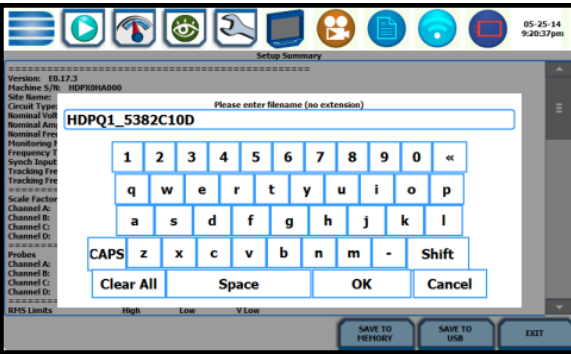
Action...	Result...
<p>STEP 1: From the Start Menu, press View/Save Monitoring Setup. Setup summary displays the parameter settings in effect.</p> <ul style="list-style-type: none"> • Press and drag the scrollbar to move the page up or down. • Press Save to Memory if you want to save the monitoring settings to internal memory. Proceed to Step 2. • Press Save to USB if you want to save the monitoring settings to an external USB device. Make sure the device is plugged into the USB port. Proceed to Step 3. 	 <p style="text-align: right;">HDPQ-437</p>
<p>STEP 2: Use the onscreen keyboard to enter a new filename for the monitoring setups to be stored in the instrument's internal memory. When done click on OK.</p>	 <p style="text-align: right;">HDPQ-438</p>

Continued on next page

View/Save setups
(continued)

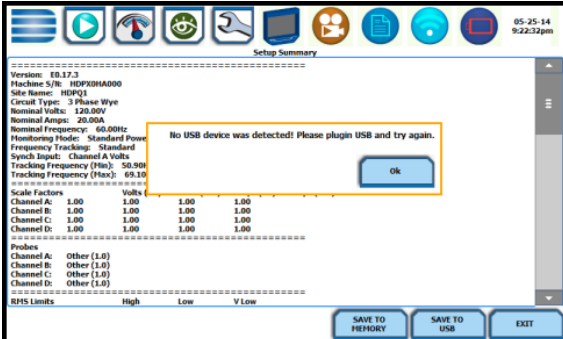
Action...	Result...
<p>STEP 3: Use the onscreen keyboard to enter a new filename for the monitoring setups to be stored in the external USB device. When done click on OK.</p> <p>NOTE: If there is no USB device plugged in, a message appears to indicate that no USB device is detected. Click on OK, plug in the USB device and try again.</p> <ul style="list-style-type: none"> • When done reviewing or saving setup summary, press Exit. The screen returns to Start Menu. 	 <p>The screenshot shows the 'Setup Summary' screen with a yellow box highlighting the error message: 'No USB device was detected! Please plugin USB and try again.' Below the message is an 'Ok' button. The screen also displays various monitoring parameters including Version (ED.17.3), Machine Type (HDPQHA000), Site Name (HDPQ1), Circuit Type (3 Phase Wye), Nominal Volts (120.00V), Nominal Amps (20.00A), Nominal Frequency (60.00Hz), Monitoring Mode (Standard Power), Frequency Tracking (Standard), Synch Input (Channel A Volts), Tracking Frequency (Min) (50.500), Tracking Frequency (Max) (69.10), Scale Factors (Volts), Channel A-D (1.00), Probes (Other (1.0)), and RPS Limits (High, Low, V Low). At the bottom, there are buttons for 'SAVE TO MEMORY', 'SAVE TO USB', and 'EXIT'.</p> <p style="text-align: right;">HDPQ-439</p>

CHAPTER 5



Instrument Settings

Overview

Introduction

This chapter describes the miscellaneous tasks that you can perform to keep the HDPQ Explorer running efficiently. These are tasks that you might perform only occasionally.

Instrument Settings menu

All functions in this chapter are found under the Instrument Settings menu. Follow these steps to display the Instrument Settings menu.

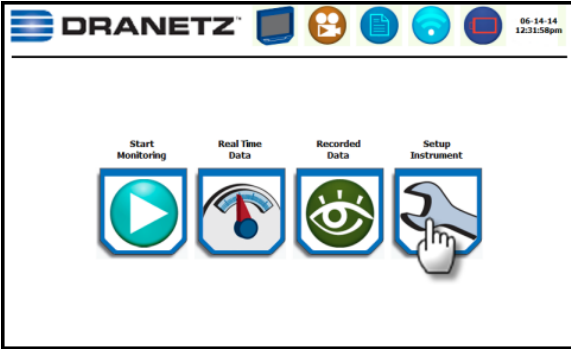
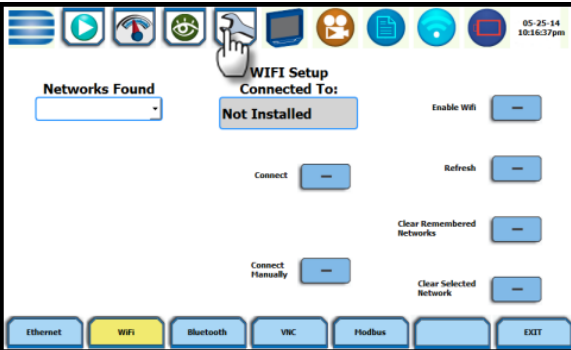
Action...	Result...
<p>STEP 1: There are three (3) ways to access the Instrument Settings menu.</p> <p>The first two ways involve the use of the Setup Instrument icon:</p> <p>1st: Upon instrument power-up and prior to monitoring, the Home page displays shortcut buttons, one of which is Setup Instrument. Proceed to Step 2.</p>	 <p style="text-align: right;">HDPQ-110a</p>
<p>2nd: Setup Instrument icon is also accessible on the taskbar of most typical screens, where shortcuts to common instrument functions are found.</p> <p>Example: You can access Setup Instrument from the taskbar of the Communications setup screen. Proceed to Step 2.</p>	 <p style="text-align: right;">HDPQ-302</p>

Continued on next page

Instrument Settings menu (continued)

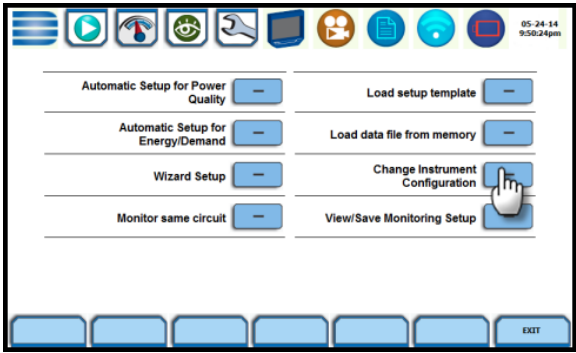
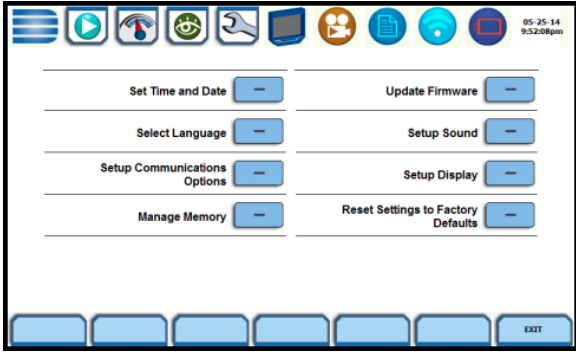
Action...	Result...
<p>The third way to access Instrument Settings is through the Start Menu.</p> <p>3rd: From the Start Menu, press Change Instrument Configuration. The Instrument Settings menu will be displayed. Proceed to Step 2.</p>	 <p style="text-align: right;">HDPQ-401</p>
<p>STEP 2: The Instrument Settings menu will be displayed. Refer to the particular section for information on each function.</p>	 <p style="text-align: right;">HDPQ-501</p>

In this chapter The following topics are covered in this chapter.



Topic	See Page
Time and Date Settings	5-3
Select Language	5-6
Communications Options	5-7
Set Up the HDPQ Xplorer for Wireless (WiFi) Connectivity	5-15
Set Up the HDPQ Xplorer for Bluetooth Connectivity	5-19
Download Data Remotely via Network, WiFi & Bluetooth PAN	5-21
Download Data Remotely via USB Connection	5-22
Manage Memory	5-23
Update Firmware	5-25
Setup Sound	5-28
Setup Display	5-29
Reset to Factory Defaults	5-30

Time and Date Settings

Time and Date display

You have the option to set the exact time and date, as well as select the format of how time and date will appear on screen. You can also set the instrument to automatically adjust for daylight saving time (DST) changes. Set the time zone applicable to your application using the Time Zone drop down selection list.

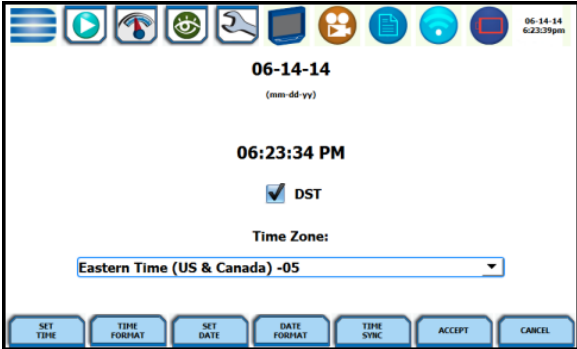
NOTE: Time and/or date cannot be changed if monitoring is on.

Action...	Result...
<p>STEP 1: From the Instrument Settings menu, press Set Time and Date.</p> <ul style="list-style-type: none"> • Press Set Time to change the time settings. Proceed to Step 2. • Press Time Format to select the format to display time on screen. Toggles between two time format selections (as screens show): <ul style="list-style-type: none"> • digital using 1 to 12 hr format (AM/PM) • digital using 1 to 24 hr format • Press Set Date to change the date settings. Proceed to Step 3. • Press Date Format to select the format to display date on screen. Toggles between the following date format: <ul style="list-style-type: none"> • mm-dd-yy • dd-mm-yy • Press Time Sync to set time synchronization preferences and related information. Proceed to Step 4. • Press Accept to save any changes made and return to the Instrument Settings menu. • Press Cancel to return to the Instrument Settings menu without saving any changes. 	<p>12-hour Time Format</p>  <p>HDPQ-502</p> <p>24-hour Time Format</p>  <p>HDPQ-502b</p>

Continued on next page

Time and Date display (continued)

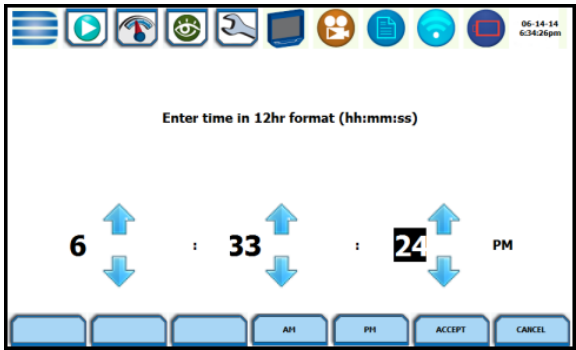
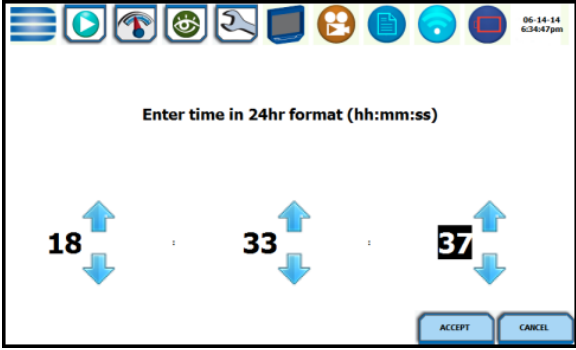
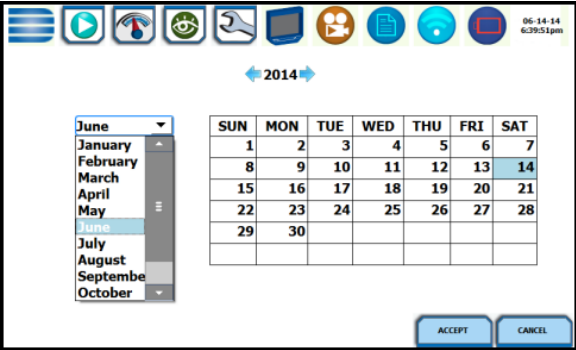
Action...	Result...
<p>STEP 2: Press the Up/Down arrow keys to specify new time settings. Use the leftmost arrow key to set the hour, the middle to set minutes, and the rightmost to set seconds. Each time you press the up/down arrow key, the value increments/decrements by one.</p> <p>NOTE: For 12-hour time format, use the AM or PM key to indicate the time setting.</p> <ul style="list-style-type: none"> • Press Accept to save any changes made and return to the Set Time and Date screen. • Press Cancel to return to the Set Time and Date screen without saving any changes. 	 <p style="text-align: right;">HDPQ-503</p>  <p style="text-align: right;">HDPQ-503b</p>
<p>STEP 3: Use the arrow keys to specify the calendar year. Each time you press the right/left arrow key, the year (starting from current) increments/decrements by one. When done, select the calendar month from the drop-down list, then select the calendar date.</p> <ul style="list-style-type: none"> • Press Accept to save any changes made and return to the Set Time and Date screen. • Press Cancel to return to the Set Time and Date screen without saving any changes. 	 <p style="text-align: right;">HDPQ-504</p>

Continued on next page

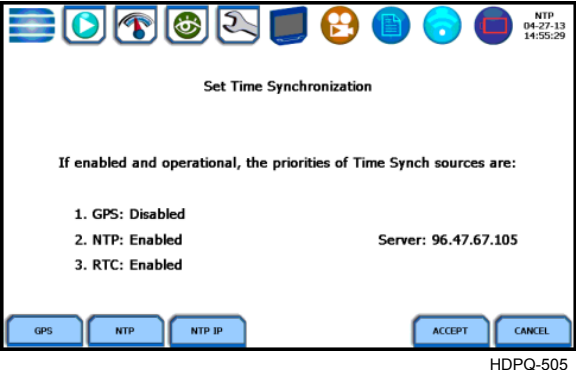

Time and Date display (continued)

Action...	Result...
<p>STEP 4: HDPQ Xplorer lets you synchronize time so that all your devices are using the same time for data recording. Time sync options include GPS, NTP or RTC. Each Time Sync Source button toggles the respective source enabled or disabled.</p> <ul style="list-style-type: none"> • Global Positioning System or GPS will access time from a GPS receiver if proper satellite receiver has access and is able to get signals from 3 satellites. • Network Time Protocol or NTP will access time using the Internet NTP time service. Address must be properly set for the NTP time server. • Real Time Clock or RTC uses an internal real time clock for time synchronization. <p>If all three are enabled, time sync is sourced by the instrument in the following priority order: If GPS is available, then it is used. If not and NTP is available, then it is used. If neither GPS nor NTP is available, then RTC is used.</p> <p>NOTE: If the battery is fully discharged and only RTC time is available, the instrument reverts to the default time/date.</p> <ul style="list-style-type: none"> • Press Accept to save any changes made and return to the Set Time and Date screen. • Press Cancel to return to the Set Time and Date screen without saving any changes. 	 <p>HDPQ-505</p>

Select Language

Language options

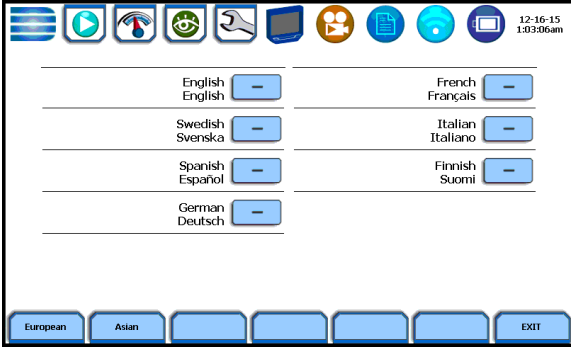
HDPQ Xplorer menu screens appear in the English language by default. You have the option to set the screen display to any of the European or Asian languages available.

Action...	Result...
<p>STEP 1: From the Instrument Settings menu, press Select Language.</p> <p>Select the desired language in which you want the text display to appear. All text display will automatically change to the selected language.</p> <ul style="list-style-type: none"> • Press the European key to display the following language selections: English, Swedish, Spanish, German, French, Italian, Finnish. • Press the Asian key to display the following language selections: Simplified Chinese, Traditional Chinese, Thai, Korean. • Press Exit to return to the Instrument Settings menu. 	 <p>HDPQ-506</p>  <p>HDPQ-506b</p>

Communications Options

Data communications options

HDPQ Xplorer provides several options for interfacing with a variety of equipment using different circuit types. The interfacing options support both hard-wired and wireless configurations. The hardware requirements for each option will vary depending on the type of connection and the performance needed from the configuration.

HDPQ Xplorer supports the following data communications options:

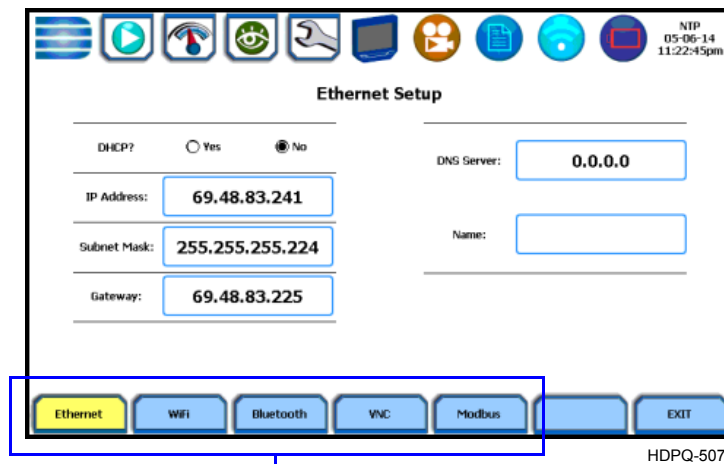

Function keys show communications options available

- **Ethernet IP connection (Wired)**

HDPQ Xplorer can be connected to any Ethernet network (10/100 MBaud Ethernet) using Ethernet/IP software protocols. The instrument must be connected to the computer network via the Ethernet cable port. Configurations using the Ethernet/IP protocol require an IP Address for network communication and a Gateway address to effectively communicate with the host device. Connection through HTTP requires connection authentication with user name and password. User Name is always "admin". The default password is "Dranetz" and can be changed on the VNC setup page.

- **Wireless (WiFi) network connection**

The wireless network connection is identical to a standard Ethernet connection except that it requires a wireless local area network (WLAN) access point or hotspot based on any of the 802.11x standards, a wireless network card installed in the HDPQ Xplorer (factory-installed at the time of purchase), and a wireless-enabled host laptop/computer.

- **Bluetooth connection**

HDPQ Xplorer requires the addition of a Dranetz-supplied Bluetooth external adapter (P/N USB-Bluetooth) in order to connect to a wireless-enabled device using the Bluetooth networking mode. The Bluetooth interface uses a PAN network that is only available on PC based devices.

Continued on next page

Data communications options (continued)

• **VNC connection**

The HDPQ Xplorer can be VNC-enabled so that any VNC Client can access the instrument remotely, provided the correct password is entered. Virtual network computing (VNC) software allows you to view and interact with the HDPQ Xplorer from any other computer or mobile device anywhere using the Internet. VNC software is cross-platform, allowing remote screen-sharing control of the HDPQ Xplorer. A VNC app or program (not supplied by Dranetz) is required on your computer, tablet or smartphone for VNC remote control.



• **Modbus connection**

HDPQ Xplorer can also be connected for realtime measurement reading via Modbus/TCP protocol.

Exit communications settings

When done configuring data communications settings, press Exit to save any changes made and return to the Instrument Settings menu. Pressing Exit will store the values in the instrument.

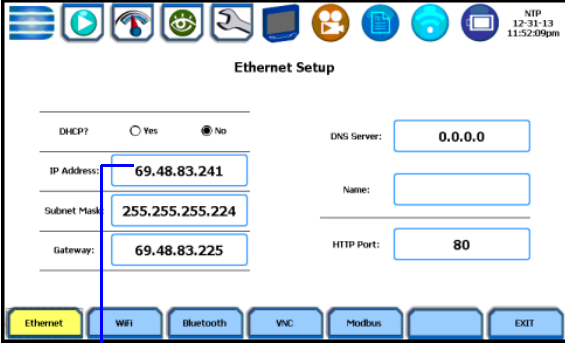
Ethernet setup This section defines the screen interface for Ethernet IP setup.

Action...	Result...
<p><u>ETHERNET SETUP</u> Set the communication protocols used for Ethernet IP connection, as necessary.</p> <p>DHCP - Dynamic Host Configuration Protocol (DHCP) allows the client to receive its IP address from the DHCP server.</p> <p>IP Address - use the numeric keypad to enter the IP Address for network communication. Entering the correct IP address will enable the instrument to communicate with the network.</p> <p>NOTE: Prior to entering the IP settings, make sure that the unit is connected to the computer network via the Ethernet cable port. You have the ability to connect to the HDPQ Xplorer mainframe via the Ethernet cable.</p> <p>Subnet Mask - masks an IP address, and divides the IP address into network address and host address for security and performance purpose. Enter the Ethernet Subnet Mask in the appropriate field. Use the numeric keypad to enter the Subnet Mask setting.</p> <p>Gateway - a Gateway is a node (a router) on a TCP/IP network that allows you to gain entrance into a network and vice versa. Use the numeric keypad to enter Gateway in the appropriate field.</p>	 <p style="text-align: right;">HDPQ-507</p>  <p style="text-align: right;">HDPQ-508</p>

Continued on next page

**Ethernet setup
(continued)**

Action...	Result...
<p>DNS Server - server that stores the DNS records for a domain name. Use the numeric keypad to enter the DNS Server in the appropriate field.</p> <p>Name - refers to the address of the DNS server. Use the numeric keypad to enter the server name in the appropriate field.</p> <p>HTTP Port - allows you to connect to the network host to send and receive data via the network. Use the numeric keypad to enter the port setting in the appropriate field.</p>	

Wireless (WiFi) setup This section defines the screen interface for Wireless (WiFi) setup. See page 5-15 for detailed steps on how to set up the HDPQ Xplorer for wireless connectivity.

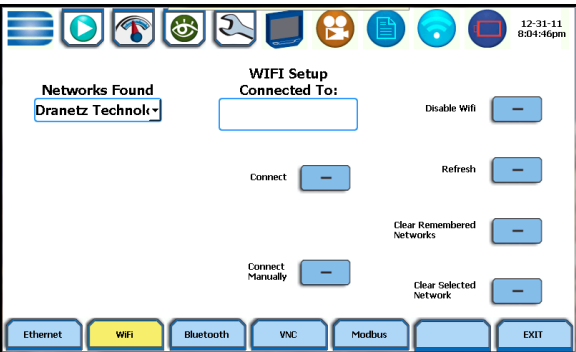
Action...	Result...
<p>WIFI SETUP</p> <p>Networks Found - use the drop down list to display the wireless network access points found within the network coverage range.</p> <p>Enable WiFi/Disable WiFi - you have the option to enable/disable wireless connectivity in your HDPQ Xplorer. When enabled, your instrument is able to connect to a wireless network access point (or hotspot), as long as within the network coverage range.</p> <p>Refresh - use to refresh WiFi connections & improve WiFi signal.</p> <p>Connect - once WiFi-enabled, use Connect to search for a wireless network access point with which the instrument can establish connectivity.</p> <p>Connect Manually - use to manually add a wireless network that you wish to connect to. This can be useful when connecting to a wireless network that does not broadcast its presence or when the security type of a wireless network is detected incorrectly. See screen on right.</p> <p>Clear Remembered Networks - use to delete network resources stored in the unit's memory cache.</p> <p>Clear Selected Networks - use to delete wireless network access points you previously identified to be trustworthy and secure.</p>	 <p>The screenshot displays the 'WIFI Setup' interface on the HDPQ-509 instrument. At the top, there is a status bar with the time '12:31:11' and date '8:8:14:16pm'. Below this is a row of icons for various connectivity options: Ethernet, WiFi (highlighted in yellow), Bluetooth, VNC, Modbus, and EXIT. The main content area is titled 'WIFI Setup' and contains the following elements: <ul style="list-style-type: none"> 'Networks Found': A dropdown menu currently showing 'Dranetz Technol...'. 'Connected To:': An empty text input field. 'Disable Wifi': A button with a minus sign. 'Connect': A button with a minus sign. 'Refresh': A button with a minus sign. 'Connect Manually': A button with a minus sign. 'Clear Remembered Networks': A button with a minus sign. 'Clear Selected Network': A button with a minus sign. At the bottom of the screen, there is another row of icons for connectivity options, with 'WiFi' selected and highlighted in yellow. The device identifier 'HDPQ-509' is printed in the bottom right corner of the screen.</p>

Bluetooth setup This section defines the screen interface for Bluetooth setup.

NOTE: The Xplorer requires the installation of a Dranetz supplied Bluetooth external adapter in order to connect to a wireless-enabled device using the Bluetooth networking mode. The Bluetooth interface uses a PAN network that is only available on PC based devices. See page 5-19 for detailed steps on how to set up the HDPQ Xplorer for Bluetooth connectivity.

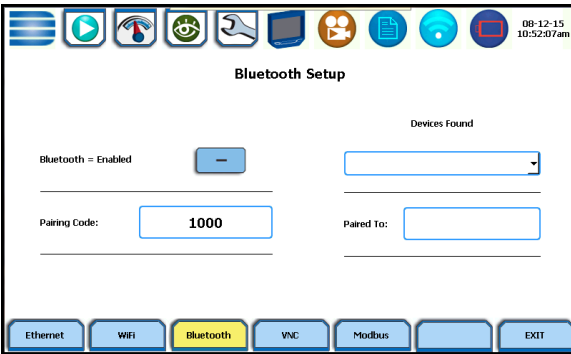
Action...	Result...
<p><u>BLUETOOTH SETUP</u></p> <p>Bluetooth = Enabled/Disabled - you have the option to enable/disable bluetooth connectivity in your HDPQ Xplorer.</p> <p>Pairing Code - refers to a code or a passkey that allows the HDPQ Xplorer to see the other device and connect to it.</p> <p>Devices Found - use the drop down list to display the list of Bluetooth-enabled devices found within the coverage range.</p> <p>Paired To - displays the name of the other device (if any) to which HDPQ Xplorer connected to.</p>	

VNC remote setup

This section defines the screen interface for VNC remote setup.

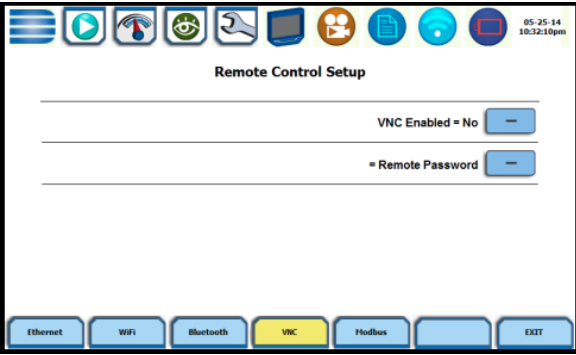
Action...	Result...
<p><u>VNC REMOTE CONTROL SETUP</u></p> <p>VNC Enabled/Disabled = Yes/ No - you have the option to enable/disable VNC setting in your HDPQ Xplorer. When VNC-enabled, any VNC Client who enters the valid password can view and interact remotely with the HDPQ Xplorer from another computer or mobile device anywhere on the Internet.</p> <p>VNC Password - you need to enter the correct password to successfully access the instrument through VNC or Ethernet HTTP connection.</p>	

Modbus setup This section defines the screen interface for Modbus setup.

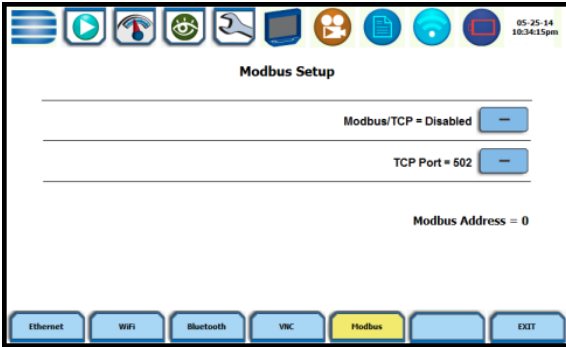
Action...	Result...
<p><u>MODBUS SETUP</u></p> <p>Modbus/TCP = Enabled/ Disabled - you have the option to enable/disable Modbus on the instrument. When enabled, your instrument is able to communicate with other devices that can request data via the Modbus/TCP protocol.</p> <p>The HDPQ Xplorer is a Modbus server and sensor/meter. Its intended application is to communicate with Modbus clients such as HMI, BMS, SCADA and other software platforms.</p> <p>TCP Port - the default port number to be used by the Modbus protocol is TCP Port 502.</p> <p>Modbus Address - the address used by the Modbus master to select which device to communicate with. With HDPQ Xplorer's implantation of Modbus/TCP, the device address is fixed as 0.</p>	

Set Up the HDPQ Xplorer for Wireless (WiFi) Connectivity

Procedure

The following procedure shows how to set up the HDPQ Xplorer for WiFi connectivity. **NOTE:** Some of the settings in the wireless setup shown below are examples of what might be detected. Network names are detected and shown. Passwords, Security Type and Encryption must be obtained depending on the network you want to connect to.

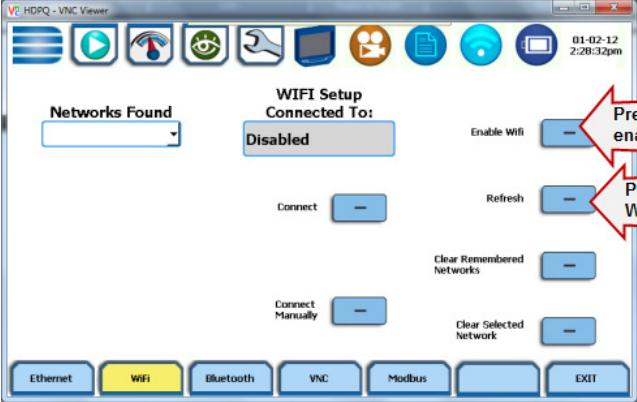
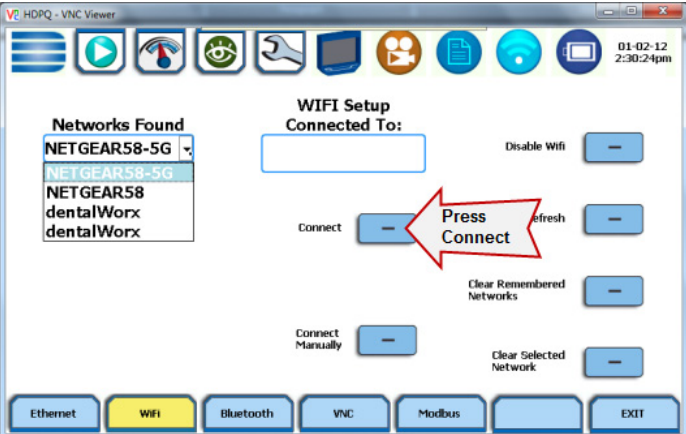
Step	Action
1	<p>Navigate to the Communications Options screen (Instrument Settings > Setup Communications Options). Select the WiFi soft key on the Communications Options screen.</p> <p>a. Press the Enable WiFi button - this will allow your instrument to connect to a wireless network</p> <p>b. Then press the Refresh button</p> 
2	<p>Under Networks Found, click on the drop-down arrow to see the list of available network access points. You should be able to see NETGEAR-58.</p> <p>a. Proceed to select the NETGEAR-58 network access point. NETGEAR-58 is an example of a WiFi network. This list will show wireless networks detected in the local area where the instrument is physically located.</p> <p>b. Then press the Connect button.</p> 

Continued on next page

**Procedure
(continued)**

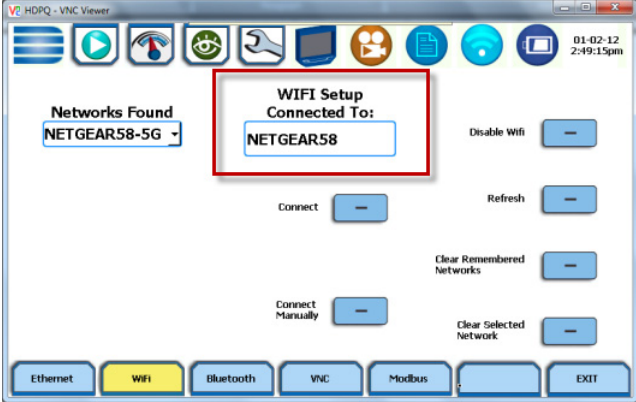
Step	Action
3	<p>The WiFi Network Setup screen is displayed. Provide the required credentials for the wireless network you are connecting to. As shown below, NETGEAR58 is an example of a WiFi network. Security Type, Encryption and Security Key or password must be obtained depending on the network you want to connect to.</p> <p><u>For NETGEAR58</u> Network name - NETGEAR58 Security Type - WPA-Personal Encryption - TKIP Security Key - DranetzisPQ (<i>case sensitive - must be entered as shown</i>)</p> <p>Press the corresponding fields and use the keyboard to enter the prescribed Network name and Security Key. Note the security key or password is case sensitive and must be written as shown. When done, press Exit.</p> 
4	<p>The WiFi Communications Options screen returns. Make sure that under the WiFi Setup Connected To box - the network name you selected is displayed. When done, press Exit.</p> 

Continued on next page

Procedure
(continued)

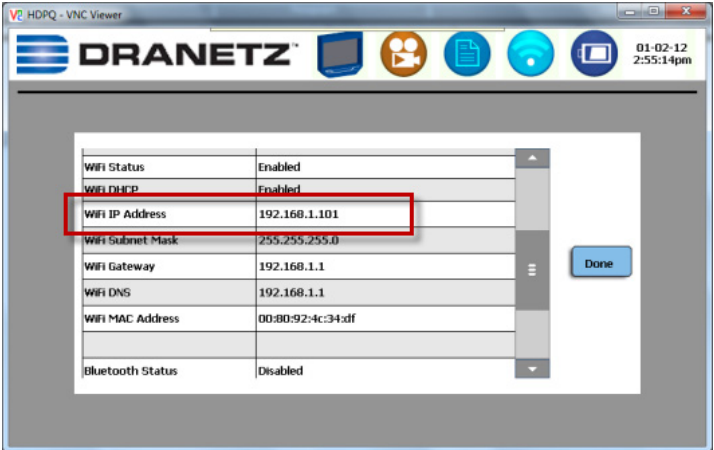
Step	Action
5	<p>Proceed to the main Home page, as shown below. Allow one minute to pass and then press the WiFi Communications icon to display the Communications Options screen.</p> 
6	<p>The Communications Options screen is displayed. Scroll down and take note of the WiFi IP Address information. Once IP address is noted, press Done.</p> 
7	<p>Open the Internet Explorer web browser. Proceed to enter the WiFi IP address you noted in the previous step into the web browser's URL field.</p> <p>NOTE: A pop-up box appears requiring you to enter the Username and Password for the instrument.</p> <ul style="list-style-type: none"> • The username is always admin, written in lowercase. • The default password is Dranetz. <p>The username and password are case sensitive, and must be entered as shown.</p>

Continued on next page

**Procedure
(continued)**

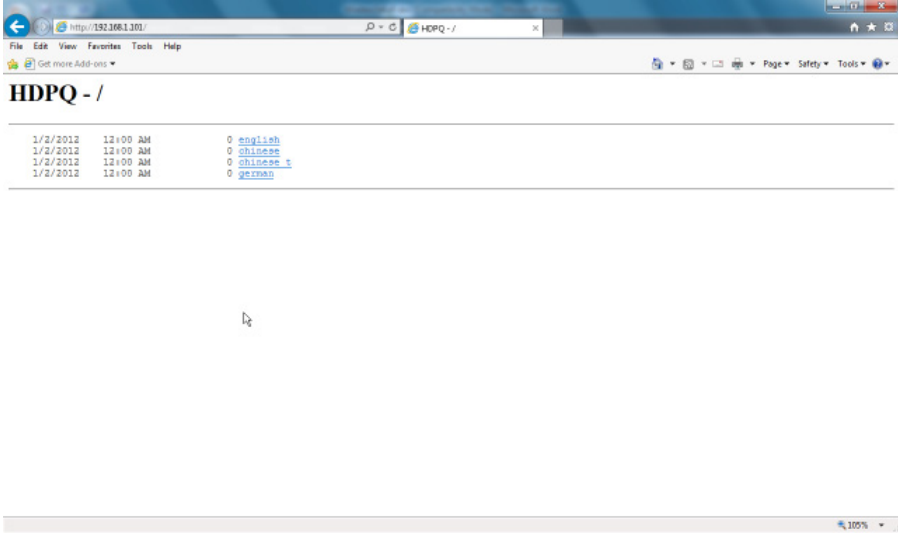
Step	Action																
8	<p>Confirm that the page shown below is displayed on your web browser.</p>  <p>The screenshot shows a web browser window with the address bar displaying 'http://192.168.1.101'. The page title is 'HDPQ - /'. Below the title, there is a table with four rows of data:</p> <table border="1"><tbody><tr><td>1/2/2012</td><td>12:00 AM</td><td>0</td><td>english</td></tr><tr><td>1/2/2012</td><td>12:00 AM</td><td>0</td><td>chinese</td></tr><tr><td>1/2/2012</td><td>12:00 AM</td><td>0</td><td>chinese t</td></tr><tr><td>1/2/2012</td><td>12:00 AM</td><td>0</td><td>german</td></tr></tbody></table> <p>The browser's status bar at the bottom indicates a zoom level of 100%.</p>	1/2/2012	12:00 AM	0	english	1/2/2012	12:00 AM	0	chinese	1/2/2012	12:00 AM	0	chinese t	1/2/2012	12:00 AM	0	german
1/2/2012	12:00 AM	0	english														
1/2/2012	12:00 AM	0	chinese														
1/2/2012	12:00 AM	0	chinese t														
1/2/2012	12:00 AM	0	german														
9	<p>Turn off power on the instrument and close your Internet Explorer web browser.</p>																

Set Up the HDPQ Xplorer for Bluetooth Connectivity

Two-step process

Setting up the instrument for Bluetooth connection involves a two-step process. Note this feature is limited to Windows® personal computers only; Android® and Apple® devices do not support PAN networks.

Set up the instrument for Bluetooth connection

As first step, you need to ensure that the instrument is equipped with a Dranetz supplied Bluetooth external adapter in order to connect to a wireless-enabled device using the Bluetooth networking mode. Then configure the Bluetooth settings on the instrument's Communications Options screen, as shown below.

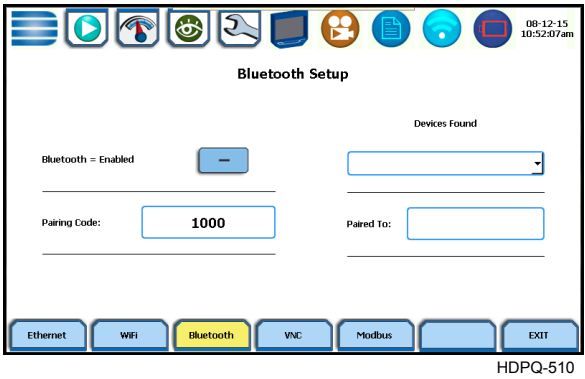
Step	Action
1	<p>Make sure that the instrument is equipped with the required Bluetooth USB adapter.</p> <p>NOTE: The Dranetz Bluetooth external adapter (P/N USB-Bluetooth) is packaged as a standard accessory with your purchase of the HDPQ Xplorer, Xplorer-400 and Guide. It is available as an optional accessory for the HDPQ Visa.</p>
2	<p>Navigate to the Communications Options screen (Instrument Settings > Setup Communications Options). Select the Bluetooth soft key on the Communications Options screen.</p> <p>Under Pairing Code - specify the default pairing code to 1000. Press the corresponding field and use the keyboard to enter the prescribed value. This code or passkey will enable the HDPQ Xplorer to see the other device and connect to it. If the pairing code is not properly set to 1000, you need to change it as necessary.</p> 
3	<p>Once the pairing code is set to the correct value, activate Bluetooth connection by pressing the button to show Bluetooth = Enabled.</p>

Set up the Computer Windows® 7 Settings for Bluetooth connection

As second step, you need to configure the Windows® 7 settings on your computer to properly communicate with the HDPQ Xplorer using Bluetooth connection.

Continued on next page

Two-step process (continued)

Set up the Computer Windows® 7 Settings for Bluetooth connection

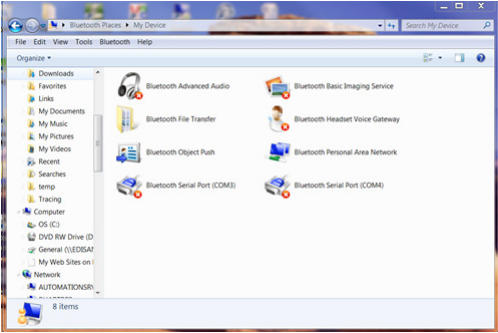
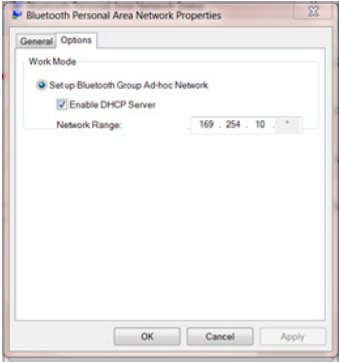
Step	Action
1	Enable the Bluetooth adapter on your computer.
2	From the system tray, double-click on the Bluetooth icon to open Bluetooth Places .
3	Right click on My Device to turn on Bluetooth. <u>Result:</u> The HDPQ icon should appear
4	Right-click on the HDPQ icon and select Pair , then enter the pairing code that you used to set up the HDQP instrument for Bluetooth connection.
5	Double-click on My Device to bring up the menu below. 
6	Double-click on Bluetooth Personal Area Network to bring up the network status menu.
7	Press Properties , then press the Options tab to bring up the menu below. 
8	Enable the Set Up Bluetooth Group Adhoc Network . Then click to Enable DHCP Server . Set the Network Range to 169.254.10.* When done, click OK .
9	Navigate back to the Bluetooth Places folder.
10	Right click on the HDPQ icon and select Connect Personal BT Ad-Hoc User .
11	The connection process should start. If successful, the HDPQ and My Device icons will change color. NOTE: At this point the HDPQ Xplorer should respond to a ping at IP address 169.254.10.10 (HDPQ fixed Bluetooth address). The VNC should also be able to connect at this address as well.

Download Data Remotely via Network, WiFi & Bluetooth PAN

Procedure

The following procedure shows how to download data remotely via network, WiFi and bluetooth PAN.

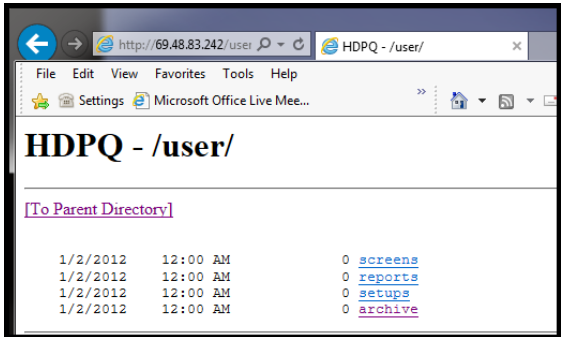
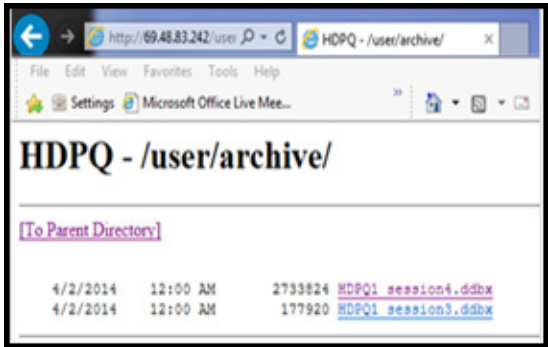
Step	Action
1	Navigate to the Manage Memory screen (Instrument Settings > Manage Memory). Select a recorded monitoring session and press Archive Locally .
2	Connect to the instrument with a web browser and enter <code>http://xxx.xxx.xxx.xxx/user</code> , where <code>xxx.xxx.xxx.xxx</code> is the IP address of the instrument.
3	Enter the Username and Password for the instrument. The username is always admin , written in lowercase. The default password is Dranetz . Passwords can be changed on the VNC setup page, under Communications settings.
4	<p>The web page will show four folders, each of which contains the following information to upload:</p>  <ul style="list-style-type: none"> • screens - contain all screen snapshots not associated with a mini report • reports - contain the Mini Reports • setups - contain the Setup files • archive - contains the ddbx data folders
5	<p>Click on any folder to see the available files to download. Proceed to select a file to download to your computer. The selected content file will be downloaded into the Downloads folder of your web browser.</p> 

Download Data via USB Connection





Procedure The following procedure shows how to download data via a USB connection.

Step	Action
1	Plug the small end of the USB active sync cable into the small USB connector on the right side of the HDPQ instrument. Plug the other end into the USB connector on your computer.
2	<p>The HDPQ instrument will plug & play, and the Windows® Mobile window will open automatically.</p> 
3	In your device, look under File Management , and click on Browse Contents .
4	<p>Navigate to the folder directory: Computer\HDPQ\FIash\User. You should see the following folders:</p> <ul style="list-style-type: none"> • screens - contain all screen snapshots not associated with a mini report • reports - contain the Mini Reports • setups - contain the Setup files • archive - contains the ddbx data folders
5	Click on any folder to see the available files to download. Proceed to select and right-click on a file and select Copy .
6	Using Windows® Explorer, navigate to the folder where you would like to upload the data. Right click and select paste to transfer the data to your computer.

Manage Memory

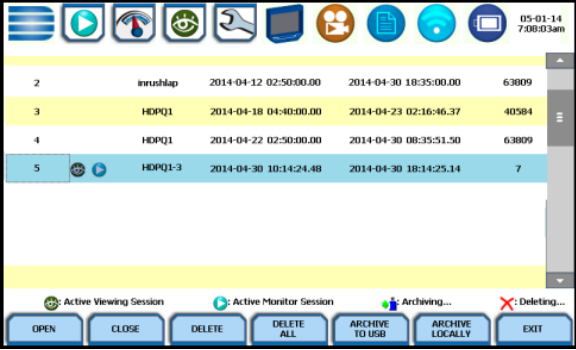
Manage files in memory

HDPQ Xplorer gives you the ability to manage data files in memory. Use the corresponding soft key to open a session file and view event records contained therein, delete session files, or copy and save files from internal memory to a USB flash drive.

Action...	Result...
<p>STEP 1: From the Instrument Settings menu, press Manage Memory. HDPQ Xplorer lists the recorded monitoring sessions, when events have been captured and stored in memory. Each recorded session is identified by a Session #, Name, the Date and Time range when monitoring started and ended, and the Number of Event Records contained in the particular session. The monitoring sessions are arranged in the order of date and time they were recorded.</p> <p>Use the scroll bar to go through the session list and scroll the page up or down.</p> <p>Select (highlight) the desired session data file.</p> <ul style="list-style-type: none"> • Press Open to bring up the Event Data & Reports menu. Proceed to Step 2. • Press Close to remove data file from the instrument's event and trend memory. • Press Delete to clear the selected (highlighted) session data file in the list. This will remove the selected file from memory. • Press Delete All to clear all session data files in the list. This will remove all data files from memory. 	 <p>HDPQ-513</p> <p>NOTE: The following icons indicate the status of action you take with a particular session data file:</p> <ul style="list-style-type: none">  -means data file is open for active viewing  -means data file is open for active monitoring  -means data file is being archived or copied to a USB flash drive  -means data file is being deleted from memory <p>NOTE: All data files stored in event memory will be lost when you press Delete All. Copy any files that you want to save to a computer first before deleting all files.</p>

Continued on next page

Manage files in memory (continued)

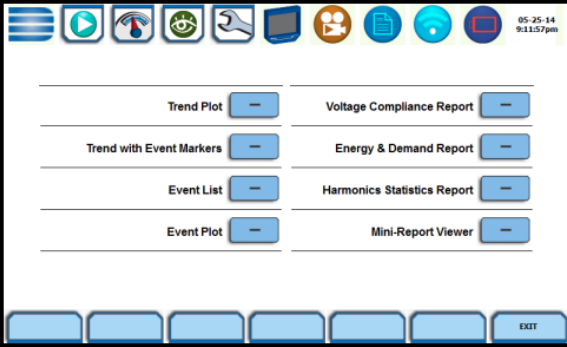
Action...	Result...
<ul style="list-style-type: none"> • Press Archive to USB to copy and save data files from internal memory to an external memory device (USB). Once the files have been saved, you will need the Dranetz Dran-View[®] program to retrieve and view the files in your computer. <p>NOTE: When saving files to USB: If the data file is open for active viewing, you have to close the file first in order to archive or save the file to the USB flash drive.</p> <p>If the data file is open for active monitoring, you have to first press stop monitoring, then view the setup session file. Once the setup file has been successfully recorded and events captured and stored in memory, you can proceed to archive or save the file to the USB flash drive.</p> <ul style="list-style-type: none"> • Press Exit to return to the Instrument Settings menu. 	
<p>STEP 2: Once you open a session data file, it will load and store it into the instrument's event and trend memory, and becomes available to be acted on by the view data screen functions. Refer to Chapter 6 View Event Data & Reports for more information.</p>	 <p>The screenshot shows a menu interface with a top bar containing icons for home, play, stop, refresh, and other functions. The main area lists several report options, each with a right-pointing arrow: Trend Plot, Voltage Compliance Report, Trend with Event Markers, Energy & Demand Report, Event List, Harmonics Statistics Report, Event Plot, and Mini-Report Viewer. At the bottom, there is a row of buttons, including an 'EXIT' button.</p>

HDPQ-435

Update Firmware

HDPQ Xplorer firmware upgrade

You can update the HDPQ Xplorer internal program by downloading the latest firmware release from the web to install into internal memory. Refer to the instructions below on how to upgrade the unit's firmware.

Firmware upgrades can be downloaded from the Dranetz website. Log on to www.Dranetz.com for the latest information on firmware update releases.

Download latest firmware file from Dranetz website

The procedure below specifies how to download the latest firmware file from the web into a USB flash drive.

Step	Action
1	Using a computer with a USB port, connect to the web and access the Dranetz URL address www.Dranetz.com . Locate the latest version of the firmware upgrade (data files "firmware.hpk" and "firmware.crc") from the Dranetz site. Dranetz regularly posts the latest information and instructions regarding HDPQ Xplorer firmware upgrade releases.
2	Insert the Dranetz USB flash drive, available as optional accessory, into the appropriate USB port in your computer. See Appendix A Optional Accessories for the part number of the USB flash drive available from Dranetz.
3	Download the latest version of the HDPQ Xplorer firmware upgrade program (data files "firmware.hpk" and "firmware.crc") from the Dranetz website to the USB flash drive. NOTE: All data and setups stored in your memory may be lost when you upgrade to the latest firmware. Major updates that require upgrade of the operating system will automatically initiate a reset to factory defaults. This will erase all data and settings. Copy any files that you want to save to a computer or USB flash drive first before downloading firmware.

The next page contains detailed instructions on how to install the latest firmware upgrade to the HDPQ Xplorer.

Install firmware upgrade to HDPQ Xplorer

The procedure below details how to install the latest firmware upgrade to the HDPQ Xplorer.

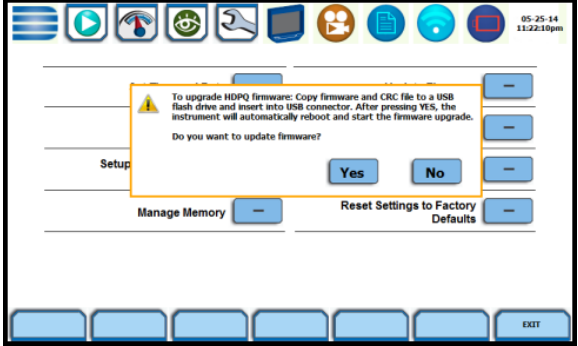
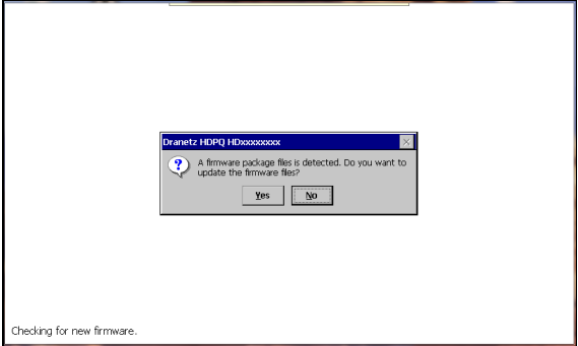
Action...	Result...
<p>STEP 1: From the Instrument Settings menu, press Update Firmware.</p> <p>The update firmware configuration screen prompts whether or not you want to proceed with firmware upgrade.</p> <ul style="list-style-type: none"> • If YES, make sure to insert the USB containing the firmware update file into the USB connector on the right side of the instrument, prior to pressing YES. The instrument will automatically reboot and firmware upgrade procedure will commence. Proceed to Step 2. • If NO, the screen returns to the Instrument Settings menu without making changes. 	 <p style="text-align: right;">HDPQ-514</p>
<p>STEP 2: Once the instrument restarts, a message indicating that a firmware package file has been detected is displayed.</p> <ul style="list-style-type: none"> • Press Yes to use the file to upgrade the instrument firmware. Proceed to Step 3. • Press No to return to the Instrument Settings menu without making any firmware changes. 	 <p style="text-align: right;">HDPQ-515</p>

Continued on next page

Install firmware upgrade to HDPQ Xplorer (continued)

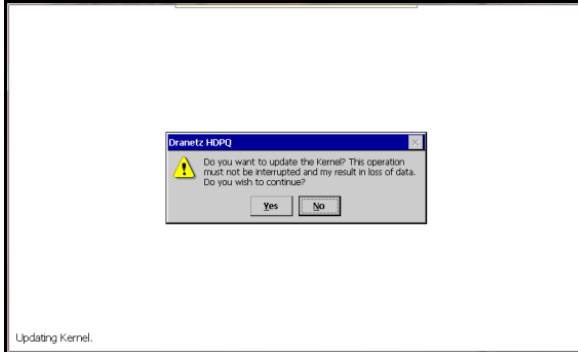
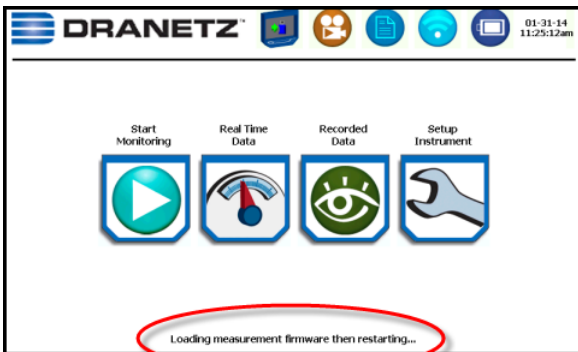
Action...	Result...
<p>STEP 3: Do not turn the power off nor remove the USB device while firmware upgrade is in progress.</p> <p>NOTE: If no errors were detected, a message indicating firmware update complete will pop up. You can safely disconnect the USB device from the instrument.</p>	 <p>HDPQ-516</p>
<p>STEP 4: A second prompt may come up to ask if the low-level Kernel will be upgraded.</p> <ul style="list-style-type: none"> • Press Yes to update the Kernel. Once the Kernel upgrade is done, the Home screen is displayed. Proceed to Step 5. • Press No if you do not want to continue with the Kernel upgrade. Proceed to Step 5. 	 <p>HDPQ-517</p>
<p>STEP 5: Once the instrument returns to the Home screen, a message at the bottom of the screen reports that the measurement firmware is being copied.</p> <p>NOTE: It is very important not to interrupt this process.</p> <p>Once the firmware upgrade is complete, the instrument automatically restarts and begins operating on the new firmware version.</p>	 <p>HDPQ-518</p>

Setup Sound

Audible alarm When set to ON, the unit will beep when threshold limits are crossed and error conditions occur. Audible alarms of short (approximately 0.1 second) duration call attention to an error condition. Alarms of long (approximately 1 second) duration signal an event trigger.

NOTE: The beep that provides audible feedback to pressing touch screen key is not affected by this setting.

Action...	Result...
<p>STEP 1: From the Instrument Settings menu screen, press Setup Sound.</p> <p>The On/Off function key toggles between turning the threshold beeper On and Off each time it is pressed.</p> <ul style="list-style-type: none"> • The unit can provide audible alarm signals when triggered. Set up the sound to turn the alarm On or Off. • Press Exit to return to the Instrument Settings menu. Any changes made will be saved. 	 <p>The screenshot shows a touch screen interface for setting the event beeper. At the top, there is a status bar with various icons and the date/time '05-25-14 11:31:18pm'. The main text on the screen reads 'Set Event Beeper' and 'Sound: ON'. At the bottom, there is a row of seven blue buttons: 'ON/OFF', followed by five unlabeled buttons, and 'EXIT'. The text 'HDPQ-519' is visible in the bottom right corner of the screen area.</p>

Setup Display

Display settings Programmable settings for the LCD screen include the backlight timer, brightness/contrast, password protection, and channel colors.

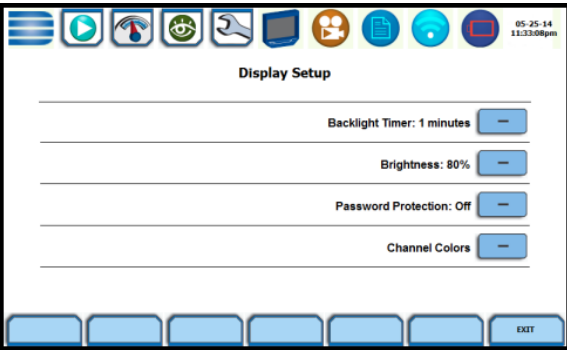
Action...	Result...
<p>STEP 1: From the Instrument Settings menu, press Setup Display.</p> <ul style="list-style-type: none"> Automatic backlight shutoff timer is provided for the LCD display. Press Backlight Timer to automatically turn off backlight after 1, 2 or 10 minutes of no user activity. Set the Backlight Timer to Always On if you do not want the backlight to shut off. Note however that this drains runtime while operating on battery. <p>NOTE: The auto-shutoff feature extends the life of the battery and should be duly considered.</p> <ul style="list-style-type: none"> Press Brightness and keep pressing to brighten/dim screen display to preferred percentage. Press Password Protection to enable/disable password log-in code to HDPQ Xplorer. When password protection is enabled and you reactivate HDPQ Xplorer from auto-shutoff (see Backlight Timer setting), the keypad screen used to enter password will appear. You need to enter the correct password to continue using HDPQ Xplorer. The message Invalid Password! will appear when an incorrect password is entered. Press Channel Colors to change the color of the parameter/channel display. Select desired color from a 28 color selection grid. Press Exit to return to the Instrument Settings menu. Any changes made will be saved. 	 <p style="text-align: right;">HDPQ-520</p>

Reset to Factory Defaults

Definition Factory configurations are the default settings of all programmable features of HDPQ Xplorer as it left the factory. Reset to factory default will erase all user data, including recorded logs and events, reports and instrument setup files.

Procedure Follow these steps to reset the HDPQ Xplorer to its factory configuration.

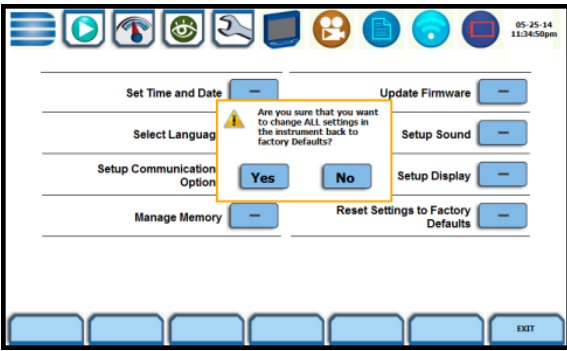
Action...	Result...
<p>STEP 1: From the Instrument Settings menu, press Reset Settings to Factory Defaults.</p> <p>A confirmation message verifies if you want to reset the instrument settings to factory configuration.</p> <p>NOTE: All saved data and setups will be lost when you reset instrument settings to factory defaults.</p> <p>On the confirmation dialog box:</p> <ul style="list-style-type: none"> • Press Yes to erase existing settings and reset the instrument to factory-configured setups. • Press No to cancel. The window returns to the Instrument Settings menu. 	 <p style="text-align: right;">HDPQ-521</p>

Factory default settings

Dranetz has set the default values for the various parameters of the HDPQ Xplorer.

Scale Factors: *1:1 for V and I, channels A, B, C, D*

Circuit Type: *Three Phase Wye*

Mode of Operation: *Monitor Off*

Nominal Value: *measured V, I, frequency*

Monitoring Mode: *Standard Power Quality*

Advanced Operations: *individual limit setups*

Transient Limits: *instantaneous peak = 3X nominal V, waveshape = 10% ,
rms dev = 10% , fast transient = 3X nominal V, none for I*

RMS Variation Limits: *10% Very Low, 90% Low, 110% High for voltage; none for current*

Journal Limits: *journalling By Time for the various parameters*

Triggers: *all V trigger; all V and I channels*

Timed Intervals

Power Values:

Power Values Interval: *10 minutes*

Demand and Energy:

Demand Sub-Interval: *5 minutes*

Demand Interval: *15 minutes*

Harmonics Journal Interval: *10 minutes*

Flicker:

Pst (Short Term) Interval: *10 minutes*

Plt (Long Term) Interval: *2 hours*

Site Name: *HDPQ Xplorer Site*

Date: *mm/dd/yy*

Language: *English*

Display:

Backlight Timer: *1 minute*

Brightness: *70%*

Password Protection: *OFF*

This page intentionally left blank.

CHAPTER 6



View Event Data & Reports

Overview

Types of data display

HDPQ Xplorer offers a graphical, information-packed, and easy to navigate display of event data. The instrument operates in various stages of acquisition, characterization, communication, and visualization of event data and journalled data.

Trends, Event List, Event Plot, and Event Waveform are available for display, with options to view detailed information either in graphic form or textual form. HDPQ Xplorer also does Voltage (Quality of Supply or QOS) compliance monitoring as specified by EN50160, or other similar voltage compliance standards.

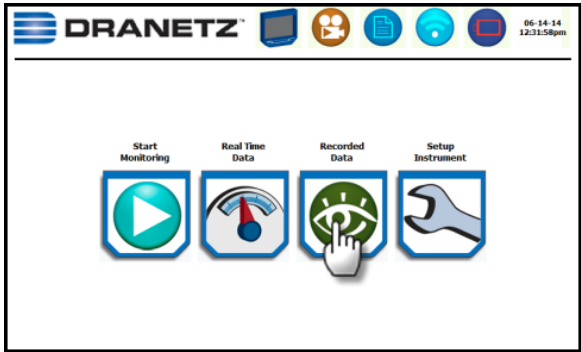

View data icons

Data and reports become available while monitoring is on or upon reading a file from internal memory or external flash drive. You need to access the Recorded Data icon to bring up the Event Data & Reports menu. While monitoring is on, you can use the Data Review icons to bring up the same data and reports menu.

Action...	Result...
<p>STEP 1: There are three (3) ways to view data and reports:</p> <p>1st: Upon instrument power-up and prior to monitoring, the Home page displays shortcut buttons, one of which is the Recorded Data icon. Press to bring up the Event Data & Reports menu. Proceed to Step 2.</p> <p>NOTE: The instrument should be able to detect data for display. Otherwise, a status message appears indicating that there is no event data available to view.</p>	 <p>HDPQ-110a</p>

Continued on next page

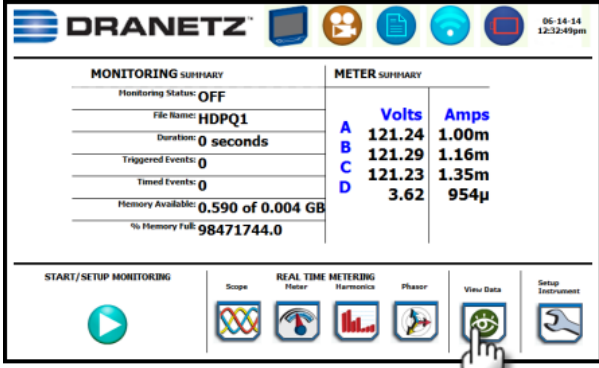
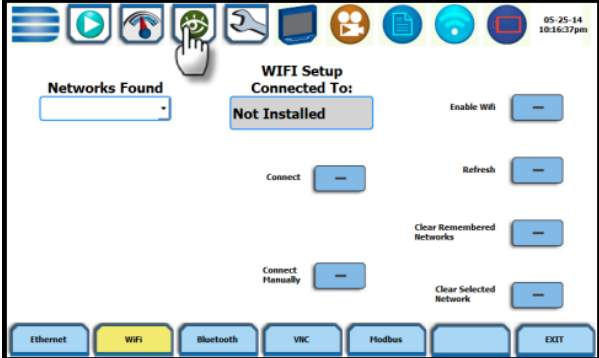
View data icons (continued)

Action...	Result...
<p>2nd: If monitoring is on, the Home Monitoring page becomes the start-up page.</p> <p>The View Data icon is available on the lower right corner of the screen. View Data brings up the Event Data & Reports menu. Proceed to Step 2.</p>	 <p>HDPQ-111c</p>
<p>3rd: Recorded Data icon is also accessible on the taskbar of most typical screens, where shortcuts to common instrument functions are found.</p> <p>Example: You can access Recorded Data from the taskbar of the Communications setup screen.</p>	 <p>HDPQ-302</p>
<p>STEP 2: The Event Data & Reports menu contains selections for Trend Plot, Trend with Event Markers, Event List, Event Plot, Voltage Compliance Report, Energy & Demand Report, Harmonics Statistics Report and Mini-Report Viewer. Refer to the particular section for information on each function.</p>	 <p>HDPQ-601</p>

Taskbar icons to view events

Once you bring up an event screen, the taskbar changes to show specialized icons that provide easy access to view event display. These icons are not common to all screens, only to event data screens. Sample screen shown below.

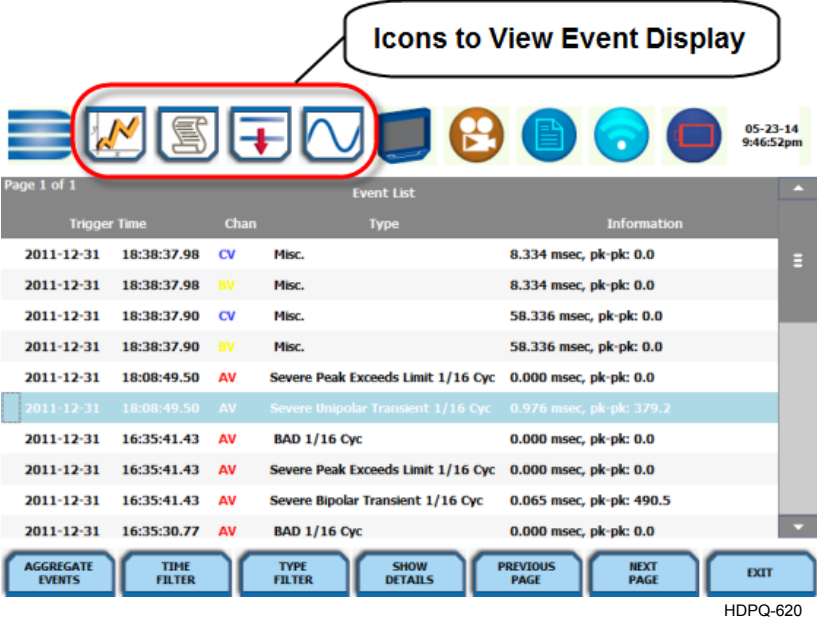

	<p>Trend Plot Displays time plots or trend visualizations of journalled data. See Section A Trend - Trend Plot.</p>
	<p>Event List Presents a summary of all captured events in the order that they occurred. See Section B Event - Event List.</p>
	<p>Event Plot (rms) Shows the voltage and current rms plots recorded for the event. Threshold values and event details can be displayed using the corresponding function keys. See Section B Event - Event Plot - RMS.</p>
	<p>Event Waveform Shows the voltage and current waveforms that were captured with the event, based on user settings. See Section B Event - Event Waveform.</p>

Event Data & Reports menu

The Event Data & Reports menu lets you select how to display recorded data, either in graphic form or textual form. These include both trended data and events generated from user programmed triggers or thresholds.

Trend Plot - displays time plots or trend visualizations of journalled data. The parameters to plot consist of journal entries listed in Chapter 4 Setup Monitoring - Timed Trigs. The trend screen can display up to four (4) stacked graphs with as many as four (4) channels in each graph. You have the option to enable/disable plot display; display area will resize according to the number of plots enabled for display. The Trend screen also features a zoom in/out key or you can use the touchscreen to manually zoom in/out of the plot display.

Trend with Event Markers - also displays trend plots but includes event markers on the time axis where there are events.

Event List - presents a summary of all captured events in the order that they occurred. Each event entry contains the date and time when the event was captured, the color coded channel/parameter of captured event, the event category, and event classification. Event list can be filtered by type and/or time.

Event Plot - allows you to view event activity graphs, event detail, with option to change and/or add parameters/channels to plot. A specialized icon to view waveform cycle display is also available on the taskbar.

Voltage Compliance Report - calculates statistical data based on the parameters required by EN50160 for determining QOS compliance. HDPQ Xplorer allows you to view voltage compliance in textual summary form or in form of a statistical bar graph.

Energy & Demand Report - defaults to a textual summary report showing Energy and Demand status and value parameters.

Harmonics Statistics Report - allows you to set up harmonics statistical reports, based on the 3-second data calculating the 95% and 99% values per IEC 61000-4-7 and IEEE 519.

Mini-Report Viewer - allows you to save the monitoring setups and/or status into a report file. The viewer opens the report to the full size of the LCD display with the taskbar on top remaining active and viewable. Reports can also be accessed using the Mini-Report Capture icon below the LCD panel.

Downloading and viewing data on a computer

Event files and reports stored in memory can also be viewed on the computer. No communication software protocol between HDPQ Xplorer and computer is necessary, though the data can be exported via USB or ethernet.

The process of downloading event data files to your computer is similar to that of moving and transferring files using the Windows® program. Once the files have been downloaded, you will need the Dranetz Dran-View® program to retrieve and view event files in your computer.

Dran-View® is owned and distributed by Dranetz. For pricing and availability, contact Dranetz Customer Service Department at (732) 287-3680 or 1-800-372-6832.

In this chapter This chapter covers the following topics.

Section	Topics	See Page
A	Trend	6-6
B	Events	6-17
C	Reports	6-34

Section A

Trend

Overview

Trend categories HDPQ Xplorer is able to display statistical trends or plots for the following parameter categories:

Standard: Parameters include the Basic (basic volts and amps), Computed Basic (displacement power factor, residual and net current), Power, Standard Demand, Standard Energy, Harmonics and Standard Flicker. These power parameters are measured more accurately using a one (1) second interval, summarized by min, max and avg values at the end of the interval.

Distortion TIF RMS, THD, Frequency: Parameters include voltage and current THD, voltage and current TID, voltage and current TIF rms, crest factor, signed and unsigned harmonic, and transformer factor.

Unbalance: Parameters include positive, negative and zero sequence components for voltage and current, as well as NEMA max-deviation from average method.

Advanced Power: Parameters include power factor calculated using arithmetic and vector sums of the individual phases.

Advanced Demand: Parameters include peak power, predicted demand, coincident power, and coincident power factor parameters. These parameters measure the ratio of maximum demand of the power distribution system to the total connected load of the system.

Advanced Energy: Parameters include energy on per phase and total basis as well as in forward and reverse mode.

Advanced Flicker: Parameters used primarily for specialized testing. Advanced Flicker parameters are calculated as per IEC 61000-4-15.

NOTE: See Chapter 4 Setup Monitoring for the detailed list of parameters available for trending.

In this section The following topics are covered in this section.

Topic	See Page
Trend Plot	6-7
Trend Plot with Event Markers	6-15

Trend Plot

What is displayed on a trend?

A trend consists of timed and threshold waveforms for the parameter on display. The trend plot can show up to four (4) stacked graphs, each graph can show up to four (4) channels on the same axis.

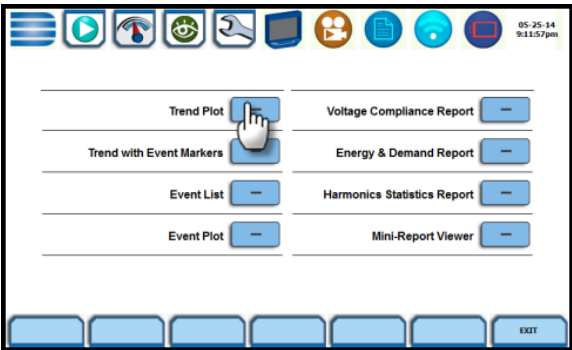
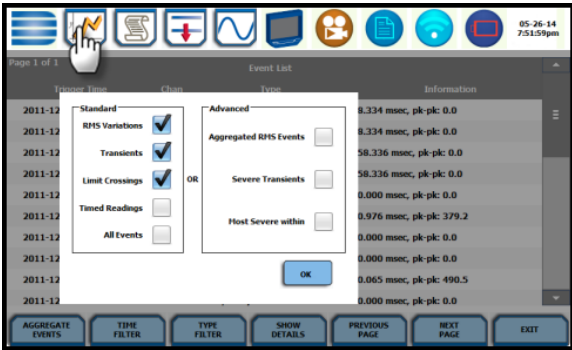
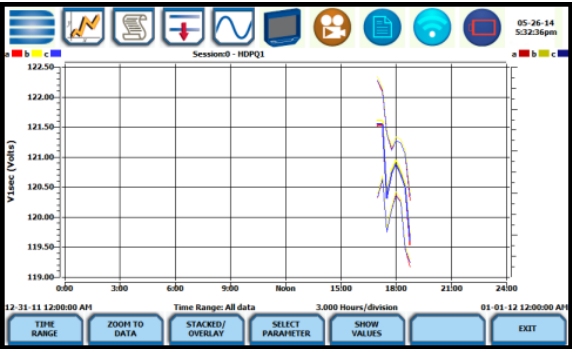
Action...	Result...
<p>STEP 1: There are two (2) ways to bring up the trend plot:</p> <p>1st: From the Event Data & Reports menu, press Trend Plot. Proceed to Step 2.</p>	 <p>HDPQ-601</p>
<p>2nd: Trend Plot icon is also accessible on the taskbar of select event data screens.</p> <p>Example: You can access Trend Plot from the Event List screen.</p>	 <p>HDPQ-621</p>
<p>STEP 2: The Trend Plot shows event data trend over a specific time range. The taskbar contains shortcut buttons typical to most screens. Use the function keys at the bottom of the screen to set up the trend display, as discussed next.</p>	 <p>HDPQ-602</p>

Trend plot function keys

The following function keys are available to set up trend plot.

Time Range - allows you to specify the time/date range used to display trend data. If you press Time Range, a pop-up window appears that lets you select the time/date range to display trend plot:

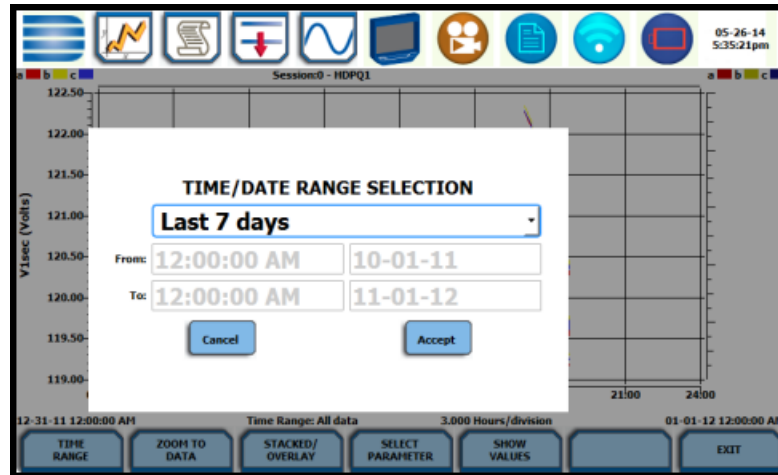

HDPQ-603

- You can trend plot for All Data or select from pre-defined time intervals. Press the window drop down arrow to display the time intervals available and select from: Custom, All Data, Last Hour, Today, Yesterday, Last 48 Hours, This Week, Last 7 Days, Last 14 Days, Last 30 Days, This Month, Last Month, This Year, Last Year, 12 months ago.
- If you select Custom, enter the Start Date/Time and the End Date/Time for which you want to display trend data.

Press **Accept** to save any changes made and return to Trend Plot. The plot display corresponds to the data specified in the date/time range.

Press **Cancel** to return to the Trend Plot without changing the plot display.

Continued on next page

Trend plot function keys (continued)

Zoom to Data - toggles between narrowing the size of the display area that lets you view trend coordinates in greater detail (Zoom to Data) and then unzoom the last step and return to the previous screen (Zoom Out).

The Zoom to Data key executes a single action that zooms in on a plot to show you the full data display. Sample screens shown below.

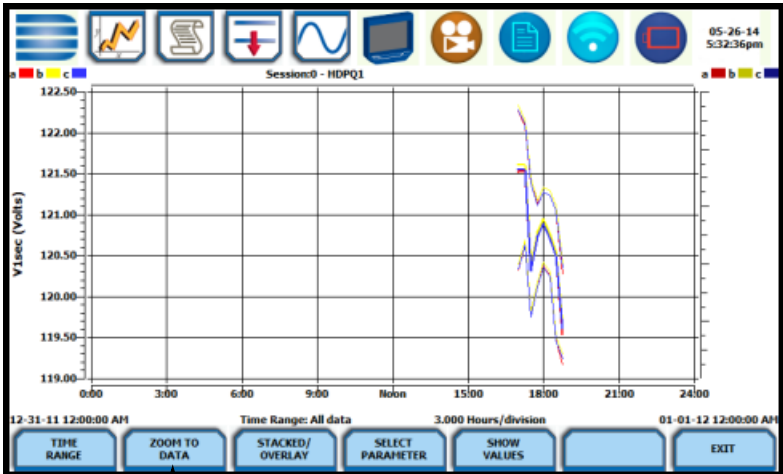

HDPQ-602

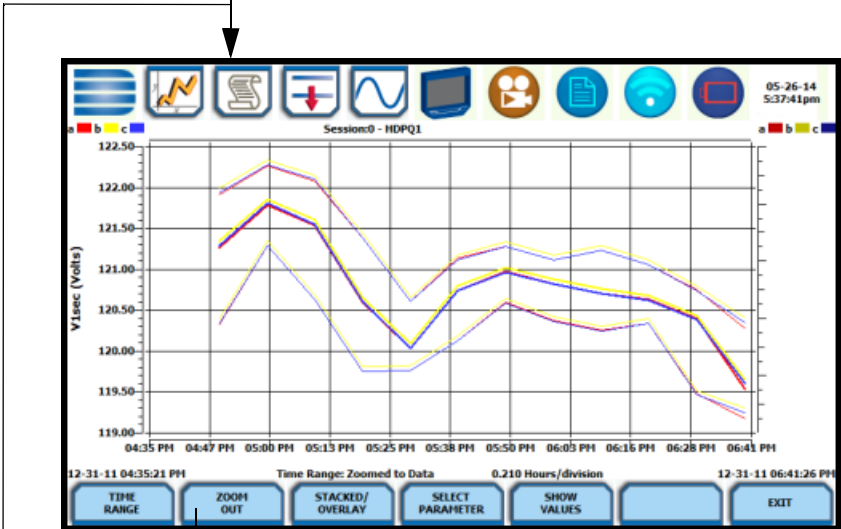

HDPQ-604

Continued on next page

Trend plot function keys (continued)

You can also use the touchscreen to manually zoom in/out of the plot display. The touchscreen allows you to magnify details, expand or narrow in a zoom area via a one finger touch and drag action.

To manually create a zoom box and zoom in on parameter(s) on the left axis, touch the screen with one finger starting from the top left and then drag to the lower right. The zoomed area will be marked by red-colored dotted box allowing you to view event data in greater detail. Sample screens shown below. To zoom in on parameter(s) on the right axis, touch the screen with one finger starting from the top right and then drag to the lower left.

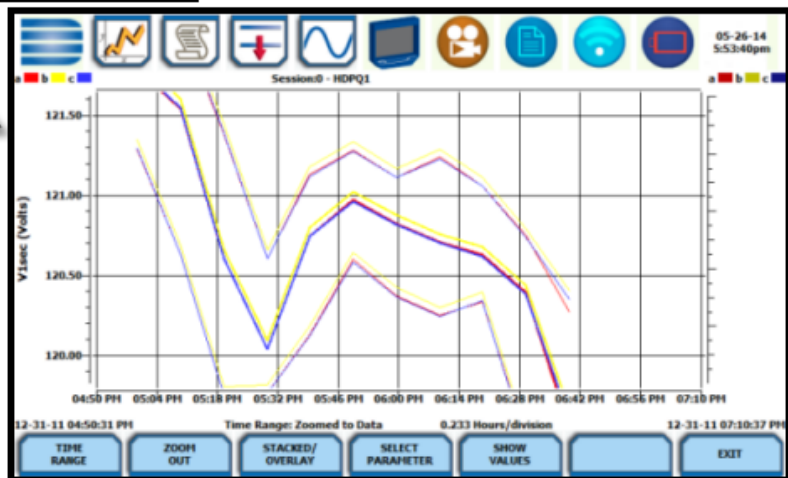
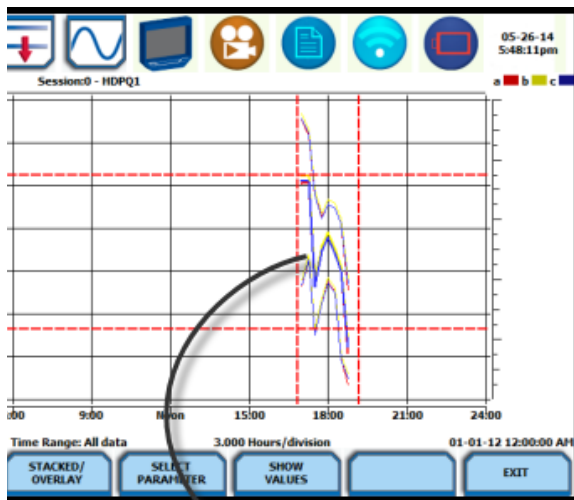

HDPQ-605

Continued on next page

Trend plot function keys (continued)

Stacked/Overlay - toggles between plotting data in a single axis plot or in separate, dual or multiple axis plots.

Trend Plot in Overlay allows you to view all voltage and current channels in the same, single axis plot. Sample plot in overlay shown below.

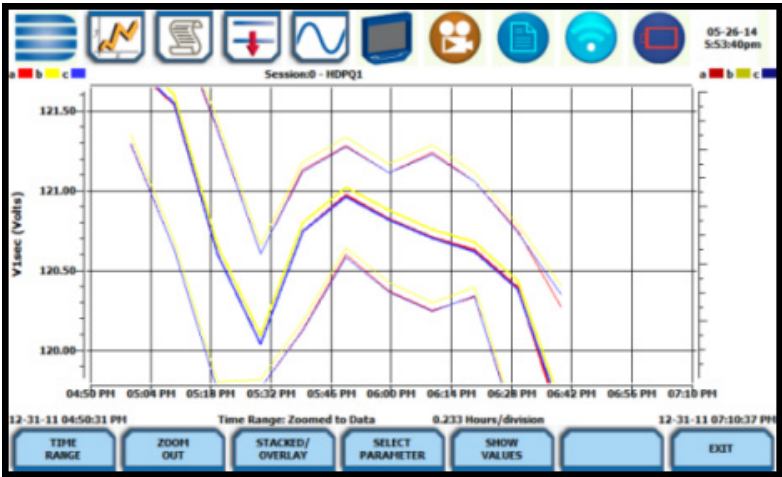

HDPQ-606

Trend Plot in Stacked view can display up to four (4) stacked graphs with as many as four (4) channels in each graph. The separate plots appear stacked in a single screen, with one plot showing all voltage channels and another plot showing all current channels. You have the option to enable/disable plot display; display area will resize according to the number of plots enabled for display. Sample plot in stacked view shown below.

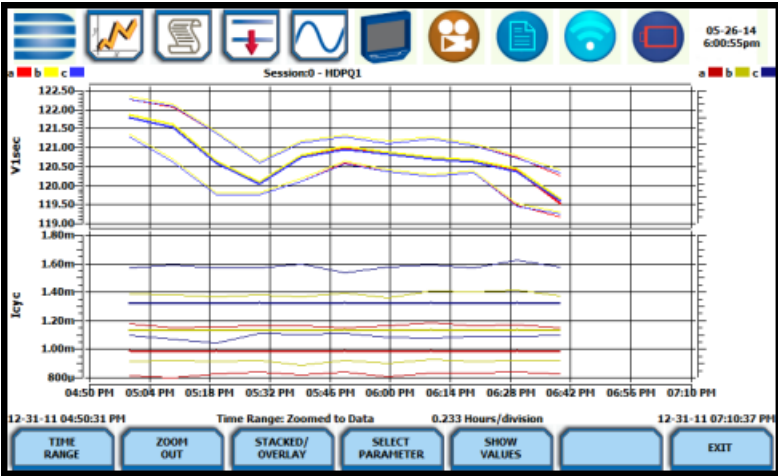

HDPQ-607

Continued on next page

Trend plot function keys (continued)

Select Parameter - allows you to change and select parameters to plot. Press Select Param to show the present parameters and channels displayed on screen.

NOTE: The trend plot retains the present configuration every time it is accessed. The channel/parameter configuration will reset to default anytime a new monitoring session starts.



HDPQ-608

Individual plot numbers appear on the left hand section of the screen. You have the option to change and/or add parameters/channels to display. The parameter selection interface gives you the ability to plot one set of parameters on the Left Y-axis and another set of parameters on the Right Y-axis. If no journal categories are set on the left axis, the right axis is automatically disabled (appears in gray). Parameters set on the left and right axis appear on a single plot allowing you to view possible trend correlations between journal categories.

Once you press the parameter field that you want to change, the journal categories from which to display statistical trends or plots appear as below.



HDPQ-609

Continued on next page

**Trend plot
function keys
(continued)**

When done selecting parameters/channels to trend for display, press Exit to close the Journal Categories screen and return to the Select Parameter screen. The journal categories that you selected will be displayed on the parameter selection screen, which renders the parameters available to plot.

Note the same procedure applies even when you select different journal categories to plot.

Upon return to the parameter selection screen, press **Exit** to view new plot display. The plot area will resize according to the plot numbers enabled for display.

Continued on next page

Trend plot function keys (continued)

Show Values - splits the screen on the right pane to show values (min/avg/max) where the vertical cursor line is displayed. The dotted vertical black line appears to indicate the point where the numerical data values appear on the plot. You can touch and drag the dotted cursor line onscreen and note how values on the right pane change to show corresponding plot values. The time range based on which data is plotted appears below the plot display.

The values are identified by the color coded channel/parameter of captured events on plot display. Pressing this soft function key repeatedly alternately toggles between hiding/showing data values.

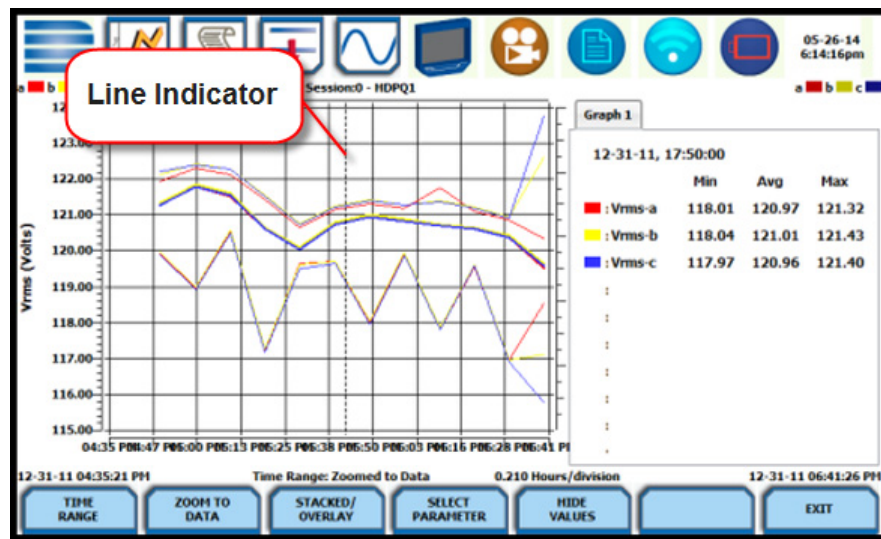

HDPQ-610

Press **Exit** to return to the Event Data & Reports menu.

Trend Plot with Event Markers

View trend with event markers Event markers appear on the time axis where there are events.

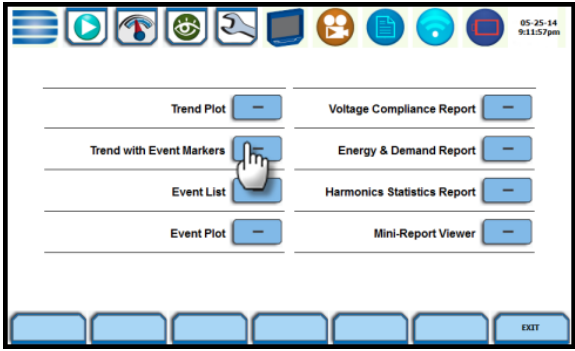
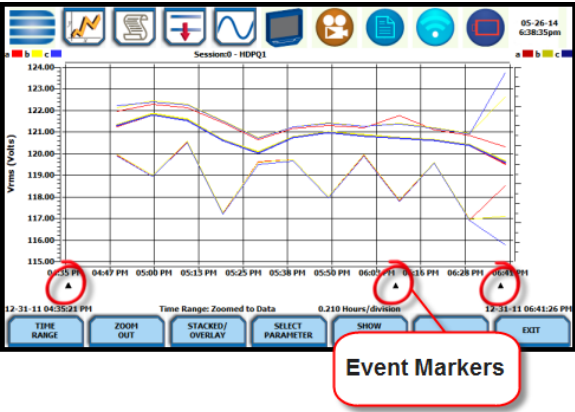
Action...	Result...
STEP 1: From the Event Data & Reports menu, press Trend with Event Markers . Proceed to Step 2.	 <p>HDPQ-601</p>
STEP 2: On Trend with Event Markers, events are marked on the horizontal axis so they are easily identified. The area under the time scale where event markers are is an active area. Pressing along this strip allows you to view the event list near the time range of the event. From the Event List screen you can then select and view details about that event. See sample image below.	 <p>HDPQ-611</p>

Event markers Clicking on an event marker allows you to view the event list details.

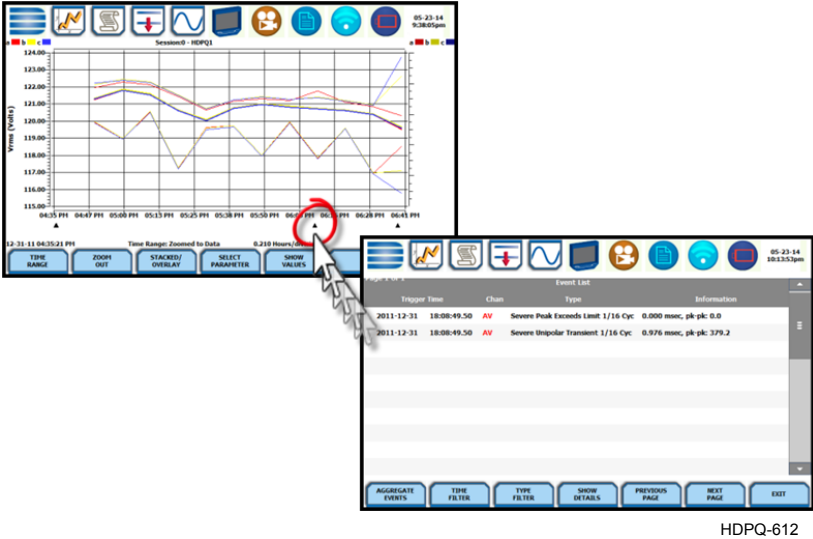

Trend with event markers function keys The same function keys described for trend plot are used to set up trend with event markers.

Time Range - allows you to specify the time/date range used to display trend data. Detailed description same as in Trend Plot.

Zoom to Data - toggles between narrowing the size of the display area that lets you view trend coordinates in greater detail (Zoom to Data) and then unzoom to return to the previous screen (Zoom Out). Detailed description same as in Trend Plot.

Stacked/Overlay - toggles between plotting data in a single axis plot or in separate, up to four axis plots. Detailed description same as in Trend Plot.

Select Parameter - allows you to change and select parameters to plot. Detailed description same as in Trend Plot.

Show Values - splits the screen on the right pane to show the values where the vertical cursor line is displayed (must be over an event marker). The dotted vertical black line indicates the point where the numerical data values appear on the plot. The dotted cursor line can be dragged by touch. Detailed description same as in Trend Plot.

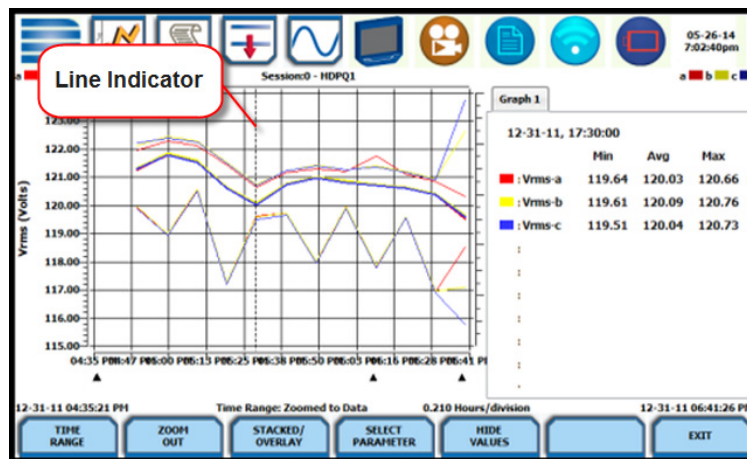

HDPQ-613

Press **Exit** to return to the Event Data & Reports menu.

Section B

Events

Overview

What is displayed on event screen?

The event screen displays actual voltage or current rms and/or waveforms that occurred when a certain threshold parameter was crossed. Time plots, event list, rms and waveform displays are visually interfaced showing event patterns and behaviors over threshold limits and time. The event screen allows you to customize data plots, change and/or add parameters/channels to plot. You can select the number of rms and waveform cycles to view, as well as display threshold values and event details.

NOTE: Event data becomes available only after monitoring has been turned on or upon reading a file from memory.

In this section

The following topics are covered in this section.

Topic	See Page
Event List	6-18
Event Plot - RMS	6-22
Event Waveform	6-28

Event List

View event list

Event List presents a summary of all captured events in the order that they occurred. If you bring up Event List from the Trend Plot with Event Markers screen, the list will start from the the aligned marker event.

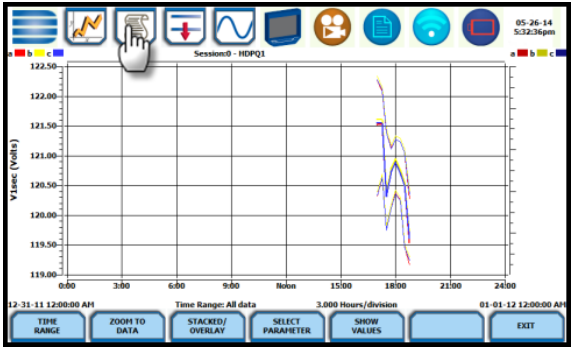
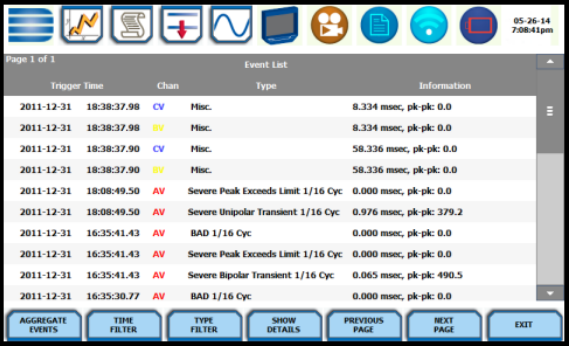
Action...	Result...
<p>STEP 1: There are two (2) ways to bring up the event list:</p> <p>1st: From the Event Data & Reports menu, press Event List. Proceed to Step 2.</p>	 <p style="text-align: right;">HDPQ-601</p>
<p>2nd: Event List is also accessible on the taskbar of select event data screens.</p> <p>Example: You can access Event List from the Event Plot screen.</p>	 <p style="text-align: right;">HDPQ-602</p>
<p>STEP 2: Each entry on Event List is identified by the date and time when the event was captured, the color coded channel/parameter of captured event, the event category and event classification. The taskbar on Event List shows the easy access icons to other event screens. The highlighted field (if any) indicates the event entry selected. Use the scroll bar to scroll through the page up or down. Use the Previous/Next Page keys to bring up the previous/next page of event entries. Event entries are arranged in groups of 30 per page.</p>	 <p style="text-align: right;">HDPQ-621</p>

**Event list
function keys**

You can filter how events are displayed on the Event List, such as by event type or by time range, using the corresponding function key at the bottom of the screen. You can also show the threshold values or event details on the right pane for selected event entries.

All Events/Aggregate Events - toggles between listing temporal aggregated events only or listing all of the events. Sample screens shown below.

Page 1 of 1

Event List

Trigger Time	Chan	Type	Information
2011-12-31 18:38:37.98	CV	Misc.	8.334 msec, pk-pk: 0.0
2011-12-31 18:38:37.98	BV	Misc.	8.334 msec, pk-pk: 0.0
2011-12-31 18:38:37.90	CV	Misc.	58.336 msec, pk-pk: 0.0
2011-12-31 18:38:37.90	BV	Misc.	58.336 msec, pk-pk: 0.0
2011-12-31 18:08:49.50	AV	Severe Peak Exceeds Limit 1/16 Cyc	0.000 msec, pk-pk: 0.0
2011-12-31 18:08:49.50	AV	Severe Unipolar Transient 1/16 Cyc	0.976 msec, pk-pk: 379.2
2011-12-31 16:35:41.43	AV	BAD 1/16 Cyc	0.000 msec, pk-pk: 0.0
2011-12-31 16:35:41.43	AV	Severe Peak Exceeds Limit 1/16 Cyc	0.000 msec, pk-pk: 0.0
2011-12-31 16:35:41.43	AV	Severe Bipolar Transient 1/16 Cyc	0.065 msec, pk-pk: 490.5
2011-12-31 16:35:30.77	AV	BAD 1/16 Cyc	0.000 msec, pk-pk: 0.0

AGGREGATE EVENTS TIME FILTER TYPE FILTER SHOW DETAILS PREVIOUS PAGE NEXT PAGE EXIT

HDPQ-621

Screen above lists all combined events

Pressing the 'Aggregate Events' button displays the temporal aggregated events only

Page 1 of 1

Event List

Trigger Time	Chan	Type	Information
2014-05-23 14:09:44.04	AV	Aggregate RMS Event	0.042 secs, min: 10.8 max: 85.8
2014-05-23 14:09:44.04	BV	Aggregate RMS Event	0.042 secs, min: 10.8 max: 85.8
2014-05-23 14:09:44.04	CV	Aggregate RMS Event	0.042 secs, min: 10.8 max: 85.8
2014-05-23 14:09:44.04	AV	Aggregate RMS Event	0.042 secs, min: 10.8 max: 85.8
2014-05-23 14:09:44.04	BV	Aggregate RMS Event	0.042 secs, min: 10.8 max: 85.8
2014-05-23 14:09:44.04	CV	Aggregate RMS Event	0.042 secs, min: 10.8 max: 85.8
2014-05-23 14:08:44.03	AV	Aggregate RMS Event	0.042 secs, min: 2.9 max: 84.5
2014-05-23 14:08:44.03	BV	Aggregate RMS Event	0.042 secs, min: 2.8 max: 84.5
2014-05-23 14:08:44.03	CV	Aggregate RMS Event	0.042 secs, min: 2.9 max: 84.6

ALL EVENTS TIME FILTER TYPE FILTER SHOW DETAILS PREVIOUS PAGE NEXT PAGE EXIT

HDPQ-622

Continued on next page

**Event list
function keys
(continued)**

Time Filter - allows you to specify the time/date range used to capture events. If you press Time Filter, a pop-up window appears as below providing you two ways to select the time/date range by which to display event entries:

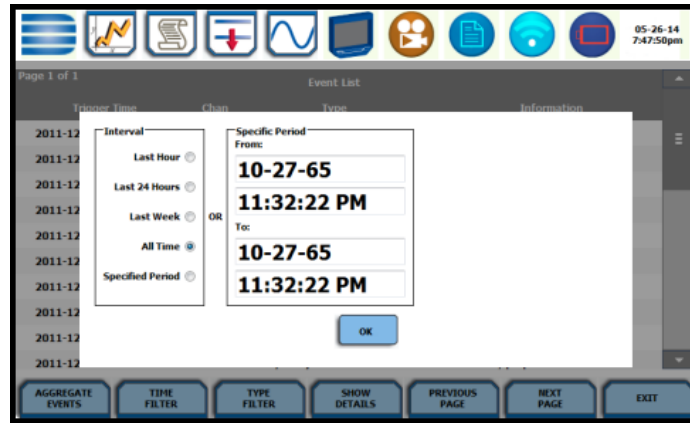

HDPQ-623

- You can select from pre-defined time intervals when the events were monitored and captured i.e. Last Hour, Last 24 Hours, Last Week, All Time or Specified Period.
- If you select Specified Period, enter the Start Date/Time and the End Date/Time based on which event entries will be displayed on list.

Press OK to save any changes made and return to the Event List. The list displayed will be filtered according to the date/time period that you specified when events were captured.

Type Filter - allows you to filter events on the list by selecting only certain types of events or by using temporal aggregation based on which events appear on list. Event categories are labelled as Standard or Advanced.

- Standard event types - include RMS Variations, Transients, Limit Crossings, Timed Readings or All Events. Press the box to check/uncheck selection. Any or all of the Standard event types can be checked. Checking any of them will uncheck any event type you may have previously selected under the Advanced categories.
- Advanced event categories - include Aggregated RMS Events, Severe Transients, or Most Severe Within. Press to check/uncheck the category with which you want to filter data to trend. Aggregated RMS Events will show parameters that are within limits (indicates Normal state). Severe Transients will show parameters that are moderately out of limits, exceeding Low or High threshold limits (indicates Moderately Severe state). Most Severe Within will show parameters that are extremely out of limits, exceeding Very Low or Very High threshold limits (indicates Most Severe state).

Continued on next page

Event list function keys (continued)

Unlike Standard event types where you can select more than one category to filter events, the Advanced categories are mutually exclusive of each other such that you can only filter and display events using one Advanced category state. Checking one Advanced category will uncheck any other criteria to filter events you previously selected.

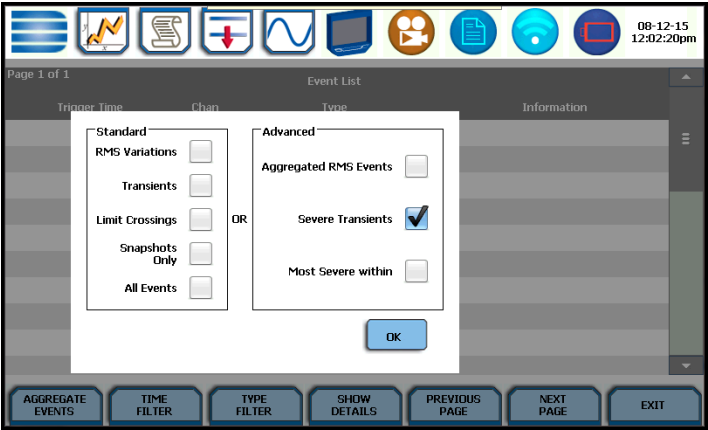

HDPQ-624

Press OK to save any changes made and return to the Event List. The list displayed will be filtered according to the type of events that you want to view.

Show Details - an event detail screen is generated for each event. Each entry is identified by the time and date when the event was captured, the event classification, and the summary details of event data showing color coded threshold values.

Triggered parameters that are within limits are shown in green. Those that are out of limits, exceeding Low or High threshold limits, are shown in red.

Trigger	Threshold	Min	Max
RMS High, Low, Very Low	132.00, 108.00, 12.00	120.098	123.757
Absolute Instantaneous Peak	204.00	167.631	656.903
RMS Distortion Waveshape	8.40	0.235664	21.7273
Cycle-to-Cycle Waveshape	12.00, 10.00%	Not Triggered	
Integrated High Frequency Trigger	Off		
06:08:49.499 PM873 Dec 31, 2011 AV Severe Pos Unipol Trans at 26.8 1/16 Cyc			
Worst Peak-to-Peak	379.27		
Duration	0.000976 SECS		
10% Magnitude / Offset	118.727 / 1240.5 u SECS		
50% Magnitude / Offset	766.84 / 1767.16 u SECS		

HDPQ-625

Press the **Event List** key if you want to bring up the Event List screen.

Press the **Exit** key to close the Event Details screen and return to the previous screen.

Event Plot - RMS

Voltage and Current channels to plot

A time plot is a graph of the value of one parameter and channel over time. HDPQ Xplorer is able to display time plots for individual Voltage and Current channels (Va, Vb, Vc, Vd, Ia, Ib, Ic, Id) or phase-to-phase Voltage channels (Vab, Vbc, Vca), depending on the available channels for Voltage and the selected circuit type.

RMS trigger parameters

RMS variation is the most common type of disturbance and is identified as a specific type of event by IEEE and IEC. Event characterization implemented in HDPQ Xplorer adheres to the IEEE 1159 and IEC 61000-4-30 Class A standards. RMS values are updated at half-cycle rates, calculated over one cycle and compared against limits on a cycle-by-cycle basis. The high and low limits can be enabled and programmed individually for each phase and phase-to-phase value.

The following parameters are required to define how an rms variation is triggered:

Very Low limit

Low limit

High Limit

As per IEEE and IEC standards for multi-phase systems, the beginning of the voltage rms event occurs when any phase voltage goes outside the limits, and ends when all of the phases are within limits for one cycle. This is only true for voltage, not current.

What is displayed on a time plot?

A time plot consists of the rms value recorded during the event for the parameter on display. The instrument give you options to change and/or add parameters/channels to plot.

Channels

Voltage: A, B, C, D, A-B, B-C, C-A

Current: A, B, C, D

View event plot - rms - Event plot consists of the rms values during the event for the parameter on display. The instrument gives you options to change and/or add parameters/channels to plot and view event details, among others.

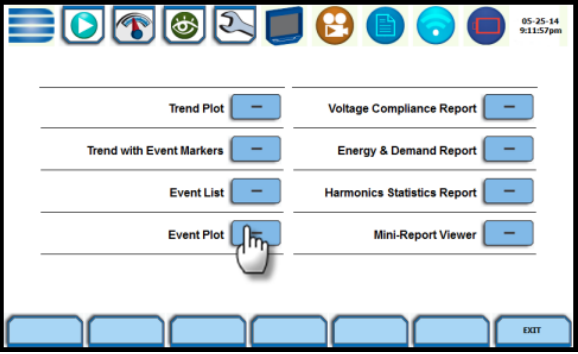
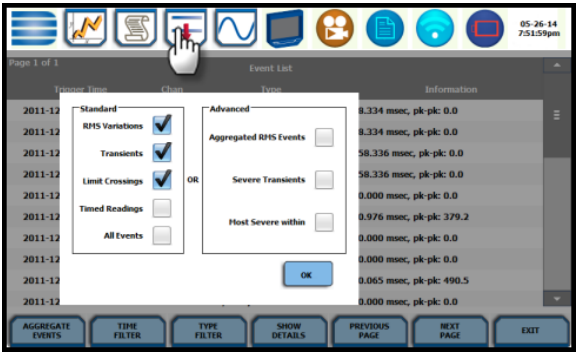
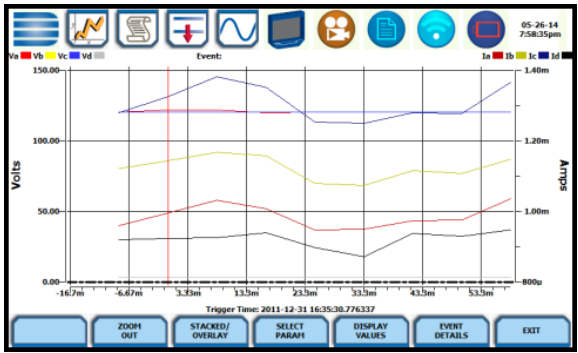
Action...	Result...
<p>STEP 1: There are two (2) ways to bring up event plot - rms:</p> <p>1st: From the Event Data & Reports menu, press Event Plot. Proceed to Step 2.</p>	 <p>HDPQ-601</p>
<p>2nd: Event Plot icon is also accessible on the taskbar of select event data screens.</p> <p>Example: You can access Event Plot from the Event List screen.</p>	 <p>HDPQ-621</p>
<p>STEP 2: Event rms plot displays actual voltage and/or current rms that occurred when a certain threshold parameter was crossed. The taskbar on Event Plot also shows the icons to access other event screens. Use the function keys at the bottom of the screen to set up the event plot - rms, as discussed in the next section.</p> <p>NOTE: Event plot displays events in rms by default. To view event plot in waveform display, press the Waveform icon on the taskbar. See section on Event Waveform.</p>	 <p>HDPQ-631</p> <p>Horizontal black dotted lines - indicate the upper and lower limits that trigger events</p> <p>Red vertical line - indicates the trigger timestamp or start of event</p>

Event plot -rms function keys

The following function keys are available to set up event plot - rms.

Zoom to Cycle - toggles between narrowing the size of the display area that lets you view event rms in greater detail (**Zoom to Cycle**) and then unzoom the last step and return to the previous screen (**Zoom Out**).

The **Zoom to Cycle** key executes a single action that zooms in on the rms plot to show you the full data display. Sample screens shown below.

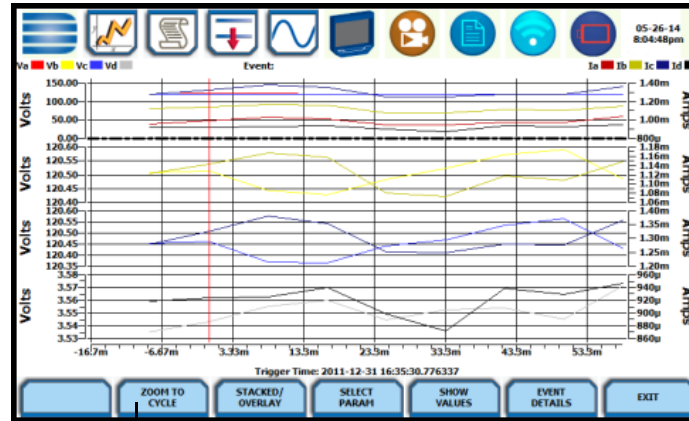

HDPQ-631

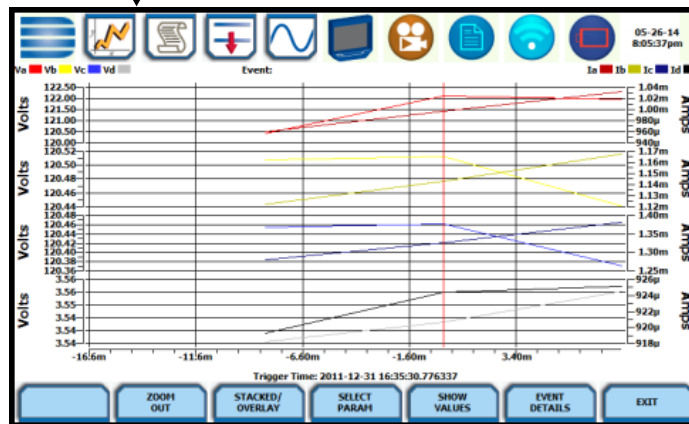

HDPQ-631b

You can also use the touchscreen to manually zoom in/out of the plot display. The touchscreen allows you to magnify details, expand or narrow in a zoom area via a one finger touch and drag action.

To manually create a zoom box and zoom in on parameter(s) on the left axis, touch the screen with one finger starting from the top left and then drag to the lower right. The zoomed area will be marked by red-colored dotted box allowing you to view event data in greater detail. To zoom in on parameter(s) on the right axis, touch the screen with one finger starting from the top right and then drag to the lower left.

Continued on next page

Event plot -rms function keys

Stacked/Overlay - toggles between plotting rms data in a single axis plot or in separate, up to four axis plots.

RMS Event Plot in Overlay allows you to view all voltage and current channels in the same, single axis plot. Sample plot in overlay is shown below.

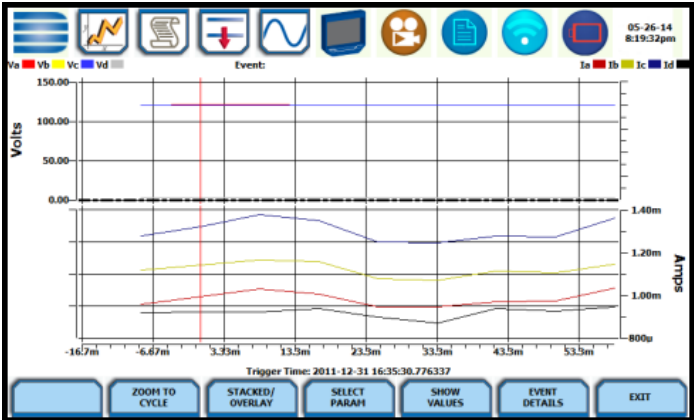

HDPQ-632

RMS Event Plot in Stacked view can display up to four (4) stacked graphs with as many as four (4) channels in each graph. The separate plots appear stacked in a single screen, with one plot showing all voltage channels and another plot showing all current channels. You have the option to enable/disable plot display; display area will resize according to the number of plots enabled for display. Sample plot in stacked view shown below.

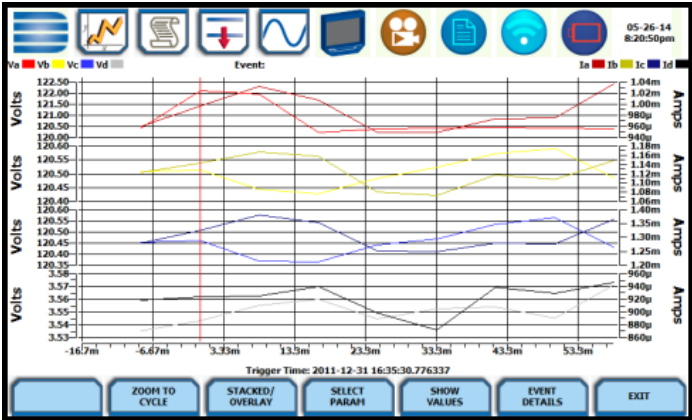

HDPQ-633

Continued on next page

Event plot -rms function keys (continued)

Select Param - allows you to change and select parameters to plot. If you press Select Param, the Change Parameter/Channel window pops up showing groupings and arrangements of parameter/channel combinations. You have the option to enable/disable channels for any of the single or multiple axis plot display. The plot display area will resize according to the number of parameters/channels enabled/disabled for display.

NOTE: Event plot retains the present configuration every time it is accessed. The channel/parameter configuration will reset to default anytime a new monitoring session starts.

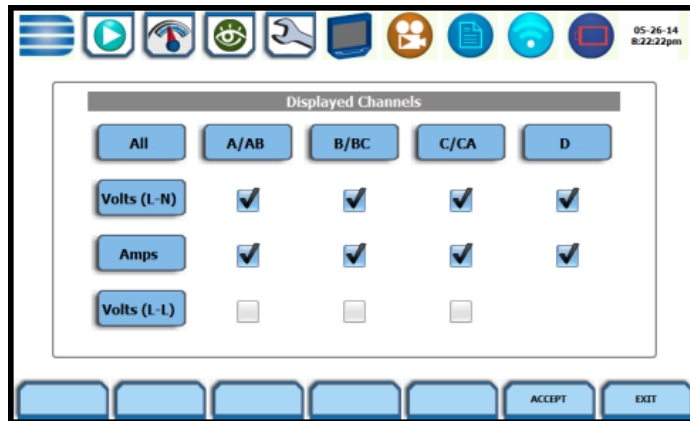

HDPQ-634

Show Values - splits the screen on the right pane to show values where the vertical cursor line is displayed. The horizontal black dotted lines indicate the upper and lower limits that trigger events. The red vertical line indicates the trigger timestamp or start of event. A dotted vertical black line appears to indicate the new point where the numerical data values appear on the plot. You can touch and drag the dotted cursor line onscreen and note how values on the right pane change to show corresponding plot values. The time range based on which data is plotted appears below the plot display.

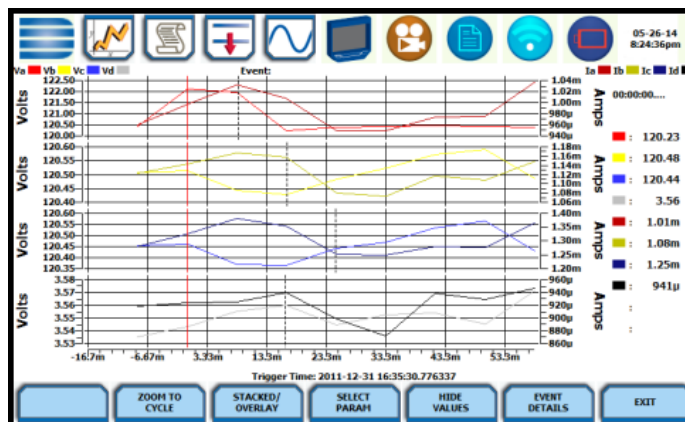

HDPQ-635

The values are identified by the color coded channel/parameter of captured events on plot display. This function toggles between hiding/showing the threshold values.

Continued on next page

Event Waveform

Event waveform display HDPQ Xplorer allows you to view events in graphic waveform display. Use the Event Waveform icon available on the taskbar of select event screens (Event List or Event Plot - rms) to plot events in waveform display.

NOTE: The instrument will only display waveform data for channels that are enabled to record waveforms. For channels that do not have associated waveform data, the screen will maintain the format, but will leave the plot blank.

Horizontal axis Auto-scaled to display all waveforms in file until range is narrowed by zoom in.

Vertical axis Auto-scaled to the minimum and maximum value within time range.

View event waveform You have the option to view events in waveform cycle display using the designated icon available on the taskbar of select event screens.

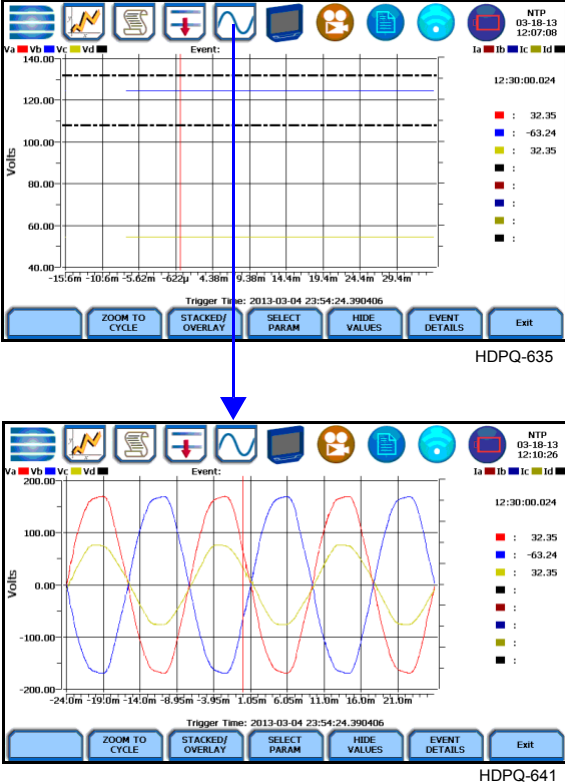
Action...	Result...
<p>STEP 1: Event Waveform icon is available on the taskbar of select event data screens.</p> <p>Example: You can access Event Waveform from the Event List or Event Plot - RMS screens.</p> <p>NOTE 1: The horizontal dotted lines indicate the upper and lower limits that trigger events. The red vertical line indicates the trigger timestamp or start of event.</p> <p>NOTE 2: The solid black lines in waveform display indicate high frequency sampling data. HDPQ Xplorer can detect and capture transients as small as 1 microsec in duration.</p> <p>Use the function keys at the bottom of the screen to set up waveform display, as discussed below.</p>	 <p>The top screenshot (HDPQ-635) displays a waveform plot with a red vertical line at 4.38m. The y-axis ranges from 40.00 to 140.00 Volts. The x-axis ranges from -15.6m to 29.4m. A legend on the right shows values for channels Va, Vb, Vc, Vd, Ia, Ib, Ic, Id.</p> <p>The bottom screenshot (HDPQ-641) displays a zoomed-in view of the waveform, showing high-frequency sampling data (solid black lines) and a red vertical line at 1.05m. The y-axis ranges from -200.00 to 200.00 Volts. The x-axis ranges from -24.0m to 21.0m.</p>

Event waveform function keys

The following function keys are available to set up event waveform display.

Zoom to Cycle - toggles between narrowing the size of the display area that lets you view event cycles in greater detail (**Zoom to Cycle**) and then unzoom the last step and return to the previous screen (**Zoom Out**). Refer to the zoom function details described in Event Plot - rms. Sample screens on magnify event waveforms are shown below.

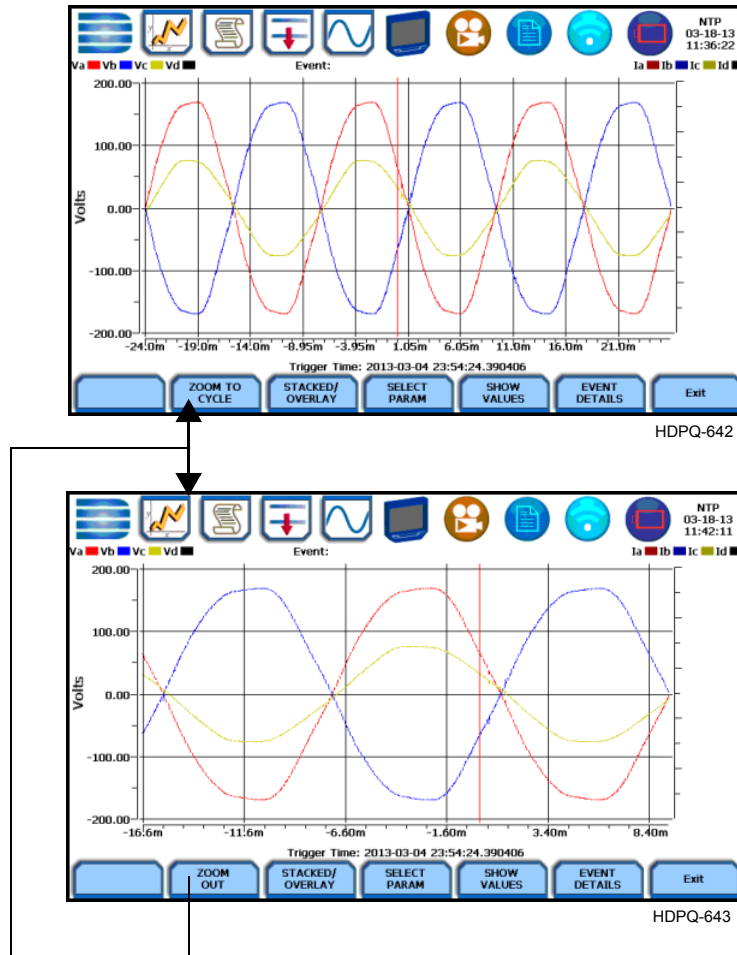

You can also use the touchscreen to manually zoom in/out of the plot display. The touchscreen allows you to magnify details, expand or narrow in a zoom area via a one finger touch and drag action.

To manually create a zoom box and zoom in on parameter(s) on the left axis, touch the screen with one finger starting from the top left and then drag to the lower right. To zoom in on parameter(s) on the right axis, touch the screen with one finger starting from the top right and then drag to the lower left. The zoomed area will be marked by red-colored dotted box allowing you to view event data in greater detail.

Continued on next page

Event waveform function keys (continued)

Stacked/Overlay - toggles between plotting event waveforms in a single axis plot or in separate, up to four axis plots.

Event waveforms in Overlay allows you to view all voltage and current channels in the same, single axis plot. Sample plot in overlay is shown below.

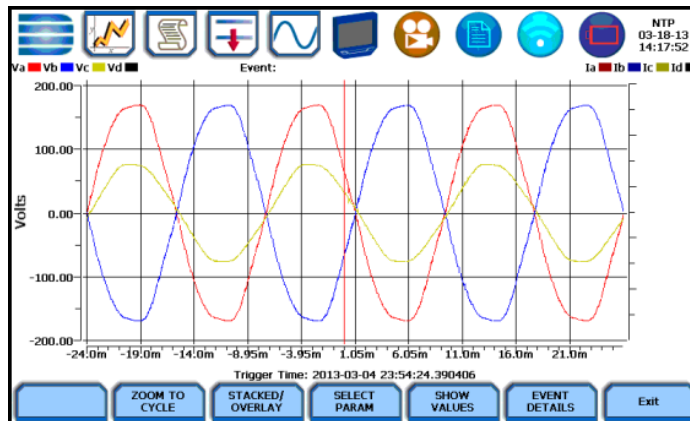

HDPQ-642

Event waveforms in Stacked view can display up to four (4) stacked graphs with as many as four (4) channels in each graph. The separate plots appear stacked in a single screen, with one plot showing all voltage channels and another plot showing all current channels. You have the option to enable/disable plot display; display area will resize according to the number of plots enabled for display. Sample plot in stacked view shown below.

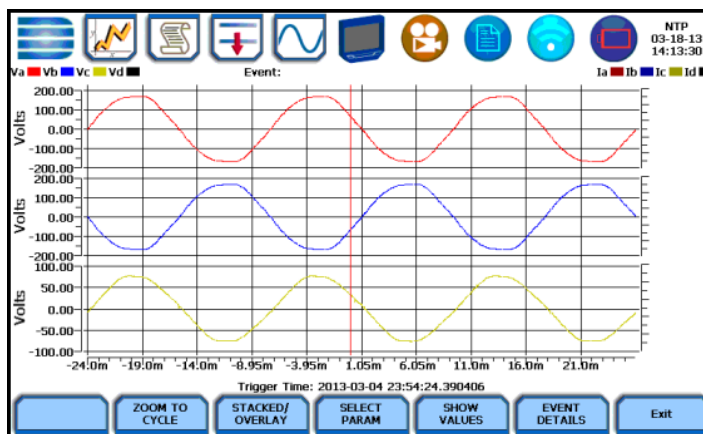

HDPQ-644

Select Param - allows you to change and select parameters to plot. If you press this, the Change Parameter/Channel window pops up showing groupings and arrangements of parameter/channel combinations. You have the option to enable/disable channels for any of the single or multiple axis plot display. The plot display area will resize according to the number of parameters/channels enabled/disabled for display. Select Param screen interface is the same for Event Plot - RMS and Waveform.

Continued on next page

Event waveform function keys (continued)

Show Values - splits the screen on the right pane to show values where the vertical cursor line is displayed. The horizontal black dotted lines indicate the upper and lower limits that trigger events. The red vertical line indicates the trigger timestamp or start of event. You can touch and drag the cursor line onscreen and note how values on the right pane change to show corresponding plot values. A dotted vertical black line appears to indicate the new point where the numerical data values appear on the plot. The time range based on which data is plotted appears below the plot display.

The values are identified by the color coded channel/parameter of captured events on plot display. If you press repeatedly, this function toggles between hiding/showing data values.

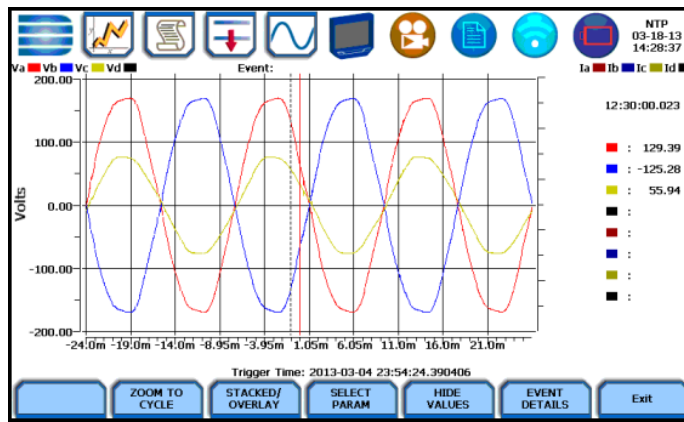

HDPQ-645

Event Details - an event detail screen is generated for each event. Event details show the triggered parameters and event data saved by the instrument, along with characterization information about the event.

Each event entry is identified by the time and date when the event was captured (shown on header row), the trigger parameters, and characterization details pertaining to the selected event entry. The threshold values captured are color coded. Triggered parameters that are within limits are shown in green. Triggered parameters that are out of limits, exceeding Low or High threshold limits, are shown in red. Event Details screen interface is the same for Event Plot - RMS and Waveform.

NOTE: Any wiring configuration, except 2 1/2 Element, monitoring voltage and current waveforms will include information on Sag Directivity in event details. See next section.

Event waveform detail: Sag Directivity HDPQ Xplorer firmware is equipped with the algorithm that determines the origin of a 3-phase voltage sag event. The sag origin or directivity can be Upstream or Downstream from the monitoring point. Direction is displayed in the Event Detail screen.

NOTE: Any wiring configuration, except 2 1/2 Element, monitoring voltage and current waveforms will include information on Directivity in the text summary. Directivity shows the origin of the sag, whether Upstream or Downstream from the monitoring point if the voltage and current signals are adequate to detect.

04-30-14 12:56:18pm			
RMS High, Low, Very Low	132.00, 108.00, 12.00	105.68	106.565
Absolute Instantaneous Peak	204.00	0.924439	171.252
RMS Distortion Waveshape	8.40	0.185957	100.826
Cycle-to-Cycle Waveshape	12.00, 10.00%	Triggered	
Integrated High Frequency Trigger	Off		
12:43:20.299 PM Apr 30, 2014 - 12:43:20.624 PM Apr 30, 2014			
CHANNEL	Av		
Category	Short Duration		
Classification	Instantaneous Sag		
Duration	20.00 cycles (0.333SECS)		
DIRECTIVITY	Upstream		
EVENT LIST EXIT			

HDPQ-646

**Event waveform
detail:
Capacitor
Switch Analysis**

In addition to determining directivity, the algorithm in HDPQ Xplorer firmware is also able to detect if 3-phase voltage and current waveforms experience a power factor capacitor switching transient.

There are four transient event types - unipolar, bipolar, oscillatory, or capacitor switch. For the latter, text detail will include capacitor switch analysis and directivity (when detected). This capacitor switching event is generated only in 3-phase voltage and current waveforms.

Event waveform detail will display the following characteristics to describe the capacitor switching event:

- The type of the event whether it is Normal, Back-to-back, or Re-strike.
 - The direction of the probable location of the switching capacitor whether it is Upstream or Downstream from the monitoring point.
-

Section C

Reports

Overview

Report options You have the option to view and set up data via the Voltage Compliance Report, Energy/Demand Audit Report, Harmonics Statistics Report or Mini-Report Viewer. Each report has their own method of presenting compliance data. Each also differs on the length of evaluation period to monitor compliance.

Quality of Supply (QOS) is a specialized report where statistical data is calculated on the required parameters specified in EN50160 to produce a PASS/FAIL decision of voltage compliance. The standard monitoring period is one complete week, beginning Sunday 00:00 (midnight). Monitoring periods of less than one week will render an evaluation status that is Incomplete and compliance marked as Undetermined.

The Energy & Demand Report allows you to monitor demand and energy parameters for energy audits, efficiency studies and cost reduction programs.

Harmonics Statistics Report allows you to set up harmonics statistical reports, based on the 3-second data calculating the 95% and 99% values per IEC 61000-4-7 and IEEE 519.

The Mini-Report Viewer allows you to view, delete or save monitoring setups and/or status into a report file. You can also save the active image on screen and append it to the report as visual aid.

In this section The following topics are covered in this section.

Topic	See Page
Voltage Compliance Report Compliance History Compliance Summary EN50160 Compliance Limits Event Statistics Min/Max Table for Power Frequency and RMS Voltage	6-35
Energy & Demand Report	6-49
Harmonics Statistics Report	6-51
Mini-Report Viewer	6-53

Voltage Compliance Report

What is EN50160?



The Voltage (QOS) functionality is equipped with monitoring and setup protocols to meet the measurements required for EN50160 monitoring. EN50160 is a European standard that stipulates the voltage characteristics that can be expected in public distribution networks. EN50160 specifies that various parameters must be within a specified percentage for 95% of the standard one week monitoring period.

EN50160 monitoring mode

EN50160 will be able to display data when the instrument has been configured to monitor EN50160 Power Quality. Refer to Chapter 4 Setup Monitoring - Section C Wizard Setup - Monitor Mode for the procedure on how to turn EN50160 Power Quality monitoring on.

View voltage compliance report

Statistical data is calculated based on the parameters required by EN50160 for determining Voltage (QOS) compliance. HDPQ Xplorer displays the parameters in the form of a compliance statistical bar chart.

Action...	Result...										
<p>STEP 1: From the Event Data & Reports menu, press Voltage Compliance Report. Proceed to Step 2.</p>	 <p>The screenshot shows a menu interface with several options: Trend Plot, Voltage Compliance Report (highlighted with a mouse cursor), Trend with Event Markers, Energy & Demand Report, Event List, Harmonics Statistics Report, Event Plot, and Mini-Report Viewer. The interface includes a top navigation bar with icons and a bottom bar with an 'EXIT' button. The device identifier 'HDPQ-601b' is visible at the bottom right.</p>										
<p>STEP 2: Voltage Compliance Report appears in the form of a table called Compliance History. Compliance History displays a summary of the QOS evaluation status, discussed in detail in the next section.</p>	 <p>The screenshot displays a 'Compliance History' table with the following data:</p> <table border="1"> <thead> <tr> <th>Evaluation Status</th> <th>Evaluation Period</th> <th>Compliance</th> <th>RMS Event Count</th> <th>Transient Event Count</th> </tr> </thead> <tbody> <tr> <td>Incomplete</td> <td>08:00:15 PM Dec 31, 2011</td> <td>Fail</td> <td>0</td> <td>0</td> </tr> </tbody> </table> <p>Below the table, there are options for 'Viewing Compliance Report' and 'Active Compliance Report', and a bottom bar with buttons for 'STATISTICS SUMMARY', 'DISDIP', 'MIN/MAX', and 'EXIT'. The device identifier 'HDPQ-651' is visible at the bottom right.</p>	Evaluation Status	Evaluation Period	Compliance	RMS Event Count	Transient Event Count	Incomplete	08:00:15 PM Dec 31, 2011	Fail	0	0
Evaluation Status	Evaluation Period	Compliance	RMS Event Count	Transient Event Count							
Incomplete	08:00:15 PM Dec 31, 2011	Fail	0	0							

Continued on next page

View voltage compliance report (continued)

Action...	Result...
STEP 2: (continued) Use the function keys at the bottom of screen to view voltage compliance summary, event statistical reports, and the min/max values for power frequency and rms voltage. Refer to the particular section for information on each function.	

Voltage compliance report function keys

The following function keys allow you to view voltage compliance summary, history and statistical reports.

For information on Compliance History, go to page 6-37.

To view Compliance Summary, press **Statistics Summary**. Go to page 6-39.

To view Event Statistics, press **DISDIP**. Go to page 6-46.

To view the min/max values for Power Frequency and RMS Voltage, press **Min/Max**. Go to page 6-48.

Press **Exit** to return to the Event Data & Reports menu.

Compliance History

QOS Status Summary

EN50160 provides a historical summary of the QOS compliance evaluations made. The standard monitoring period is one week, usually beginning Sunday at 00:00 (midnight). Any compliance evaluation performed in less than one week will receive an Evaluation Status marked as Incomplete, and Compliance marked as Undetermined. For completed monitoring periods, Compliance status may either be PASS or FAIL if all of the specified parameters is within limits for 95% or more of the monitoring time period. A PASS or FAIL status is hyperlinked to the compliance statistical bar chart.

Compliance History table

Compliance History displays a table that summarizes the QOS evaluation status. Voltage Compliance Report defaults to the Compliance History table as shown below.

Cycle Start Date	Days In Cycle	Days Into Cycle	Daily	Weekly	Monthly
May 01, 2014 01:00:00 AM	31	0			
May 01, 2014 01:00:00 AM	31	1	✓		
May 01, 2014 01:00:00 AM	31	7		✓	
May 01, 2014 01:00:00 AM	31	31			✓

HDPQ-651b

Evaluation Status: The EN50160-specified compliance evaluation period is a 7-day (one week) period. The evaluation status is Complete if monitoring is done within one full week, or Incomplete if monitoring is done in less than one week. An evaluation status is Incomplete under the following scenarios:

- It is the current evaluation period and it has simply not completed.
- It is a previous evaluation period but not enough data samples were included in the statistical analysis. This may be due to the following reasons: data was not collected or too many samples were tagged as unusable due to rms variations.

Evaluation Period: Displays the date and time of the beginning of the evaluation period. Each evaluation period is independent of each other. The default length of evaluation period is a 7-day week period by which the unit calculates information in strict compliance with the EN50160 standard.

Continued on next page

**Compliance
History table
(continued)**

Compliance: Displays a PASS (green) or FAIL (red) mark if evaluation is done for a complete 7-day week period. Compliance displays an Undetermined (black) mark for incomplete periods. A PASS or FAIL compliance status is hyperlinked to the Compliance Statistical Bar Chart that shows the seven parameters required for determining compliance.

RMS Event Count: Details of rms variation event count are shown in the EN50160 DISDIP table on page 6-46.

Transient Event Count: The complete table for Transient Overvoltages appears in the EN50160 Transient table on page 6-47.

Compliance Summary

Summary bar chart

Voltage Compliance Summary appears in the form of a statistical bar chart featuring the seven parameters required for determining QOS compliance. The color of the bar indicates compliance status. A green bar indicates that the parameter is within compliance. A red bar indicates that the parameter does not comply with the QOS limits. Each measurement parameter is discussed in the next pages.

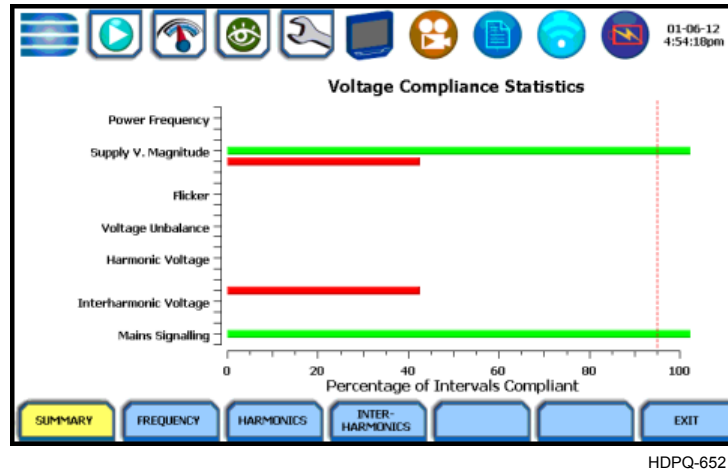

Voltage compliance measurement parameters

The voltage compliance statistical bar chart displays the seven parameters that are required for determining QOS compliance. The bar chart indicates the percentage of the intervals passing the specified compliance criteria. The color of the bar indicates compliance status. A green bar indicates that the parameter is within compliance. A red bar indicates that the parameter does not comply with EN50160 Standard.

The next pages provide brief descriptions of each measurement parameter. Particularly for three parameters, you can view component graphs using the soft keys provided - Frequency for Power Frequency graph, Harmonics for Harmonic graph and Interharmonics for Interharmonic graph.

For Voltage (QOS) compliance limit values of voltage parameters, refer to the table of Compliance Limits on page 6-43.

Press Exit to return to the Compliance History screen.

Continued on next page

Voltage compliance measurement parameters (continued)

Power Frequency: In case of a fault operation, parts of an interconnected system may become isolated. Compliance will be assessed over an observation period of one week, by a statistical analysis carried out over the sequence of 10 seconds measurement. Frequency is represented by a single value and a single bar. The dotted red line indicates the trigger timestamp or start of event.

Press the Frequency key to display the Power Frequency Graph, sample screen below.

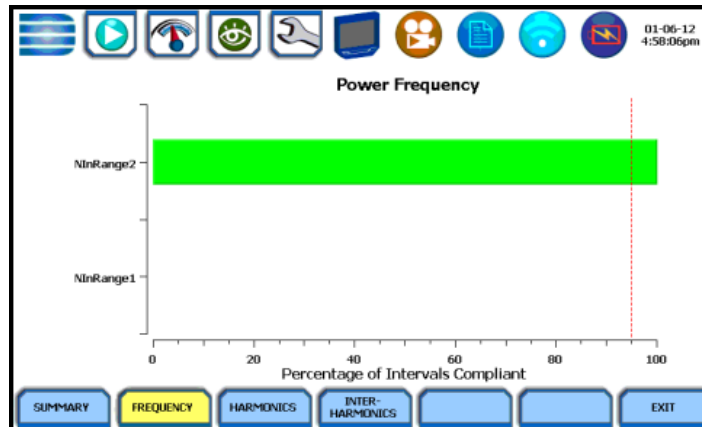

HDPQ-652a

Power Frequency parameter has two ranges considered for compliance. This graph displays the status of parameter with respect to each range. The bar chart indicates the percentage of intervals passing the specified compliance.

Supply Voltage Magnitude: Under normal operating conditions, load changes cause variations of the 10 minute average supply voltage. Generally this is compensated by automatic voltage regulation within a period of a few tenths of seconds. Supply Voltage Magnitude displays a cluster of bars, one for each phase. The color of each bar indicates the compliance status for its phase. A green bar indicates that the parameter is within compliance. A red bar indicates the parameter does not comply with QOS limits.

Flicker: Typical rapid voltage changes or flicker do not exceed a magnitude of +5% or -5% of the nominal or declared voltage. This limitation is possible because connection of loads capable of creating rapid voltage changes is usually subjected to regulations. However under certain conditions, higher values of up to 10% may occur. These higher values can occur for instance in areas where high power motor equipment (blower, pumps, compressors, etc.) is used. Flickers display a cluster of bars, one for each phase. The color of each bar indicates the compliance status for each phase. A green bar indicates that the parameter is within compliance. A red bar indicates that the parameter does not comply with QOS limits.

Voltage compliance measurement parameters (continued)

Supply Voltage Unbalance: The unbalance of a three phase supply voltage consists of a loss of symmetry of the phase voltage vectors (magnitude and/or angle), created mainly by unbalanced load. Compliance is verified when 95% of the sequence of valid 10 minute values are within the specified tolerance of normally 2% (in single phase/two phase supplies 3%). Supply Voltage Unbalance is represented by a single value and a single bar. The color of the bar indicates the compliance status for each phase. A green bar indicates that the parameter is within compliance. A red bar indicates that the parameter does not comply with QOS limits.

Harmonic Voltage: Harmonic displays a cluster of bars, one for each phase. The color of each bar indicates the compliance status that is calculated by adding the status of Total Harmonic Distortion (THD) and Harmonics 2 thru 25. The dotted red line indicates the trigger timestamp or start of event.

Press the Harmonics key to display the harmonic graph, sample screen below.

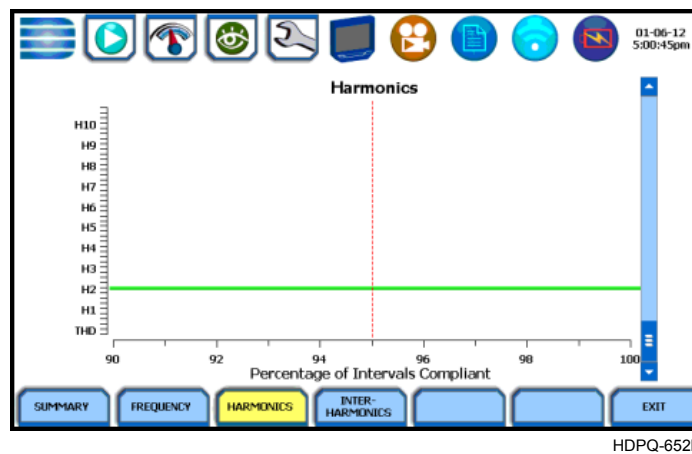

The harmonic graph displays the status of each of the individual harmonics and THD for each phase. The bar chart indicates the percentage of intervals passing the specified compliance.

NOTE: Many instruments used for harmonic measurements of power supply systems express their output with reference to the fundamental component of the voltage, especially those indicating the THD factor.

Harmonic and Interharmonic values are specified only up to order 25 (EN50160 limit), for the practical reason that for higher orders, the values are generally so small as to be impractical to measure. Another reason is because of the difficulty of giving values which would be relevant to all networks.

Continued on next page

Voltage compliance measurement parameters (continued)

Interharmonic Voltage: Interharmonic displays a cluster of bars, one for each phase. The color of each bar indicates the compliance status that is calculated by adding the status of Total Interharmonic Distortion (TID) and Interharmonics 2 thru 25. The dotted red line indicates the trigger timestamp or start of event.

Press the Interharmonics key to display the interharmonic graph, sample screen below.

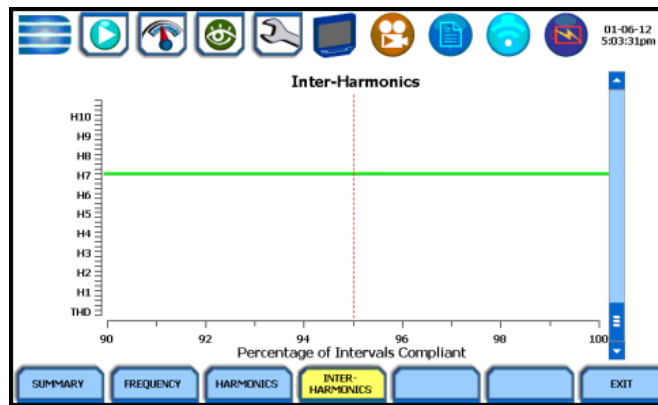

The interharmonic graph displays the status of each individual Interharmonic and TID for each phase. The bar chart indicates the percentage of intervals passing the specified compliance.

Mains Signalling: Mains Signalling is represented by a single value and a single bar. The color of the bar indicates compliance status that is calculated by adding the status of each of the defined frequencies (a maximum of five) for its phase. A green bar indicates that the parameter is within compliance. A red bar indicates that the parameter does not comply with QOS limits.

NOTE: You can specify the signalling frequency values when configuring setup parameters under Monitor Mode > Voltage Compliance (EN50160), see Chapter 4 Setup Monitoring.

EN50160 Compliance Limits (Default)

Compliance limits

The table below indicates the limit numbers or range of values required for each parameter to pass QOS compliance and satisfy EN50160 standard, as the default limits.

Parameter	Limits for QOS Compliance to Pass
Un = Low Voltage (LV) Supply nominal voltage, upper limit 1kV Uc = Medium Voltage (MV) Supply Characteristics - declared voltage, range 1kV to 35kV	
Power frequency with synchronous connection to an interconnected system	Mean value over 10 seconds <ul style="list-style-type: none"> • $\pm 1\%$ during 95% of one week • $\pm 4\%$ during 100% of one week
Power frequency with no synchronous connection to an interconnected system	Mean value over 10 seconds <ul style="list-style-type: none"> • $\pm 2\%$ during 95% of one week • $\pm 15\%$ during 100% of one week
Magnitude of the supply voltage (In low voltage systems, declared and nominal voltage are equal)	Mean rms over 10 minutes <ul style="list-style-type: none"> • $\pm 10\%$ of Un or Uc during 95% of one week • $\pm 10\%$ to 15% of Un during 100% of one week
Supply voltage variations (Under normal operating conditions, excluding situations arising from faults or voltage interruptions)	Mean rms over 10 minutes <ul style="list-style-type: none"> • $\pm 0\%$ of Un or Uc during 95% of one week • $\pm 10\%$ to 15% of Un during 100% of one week
Flicker	$Plt \leq 1$ for 95% of the time Also 5% normal, 10% infrequent for LV, 4 & 6 for MV
Supply voltage dips	No criteria specified, just reported in DISDIP table
Short interruptions of the supply voltage	<1 second for 70% of the short interruptions
Temporary power-frequency overvoltage between live conductors and earth	1.5kV for LV 170% for solid or impedance earth, 200% unearthed of resonate earth
Transient overvoltages between live conductors and earth	Short duration surges: <1 us Medium duration surges: >1 to <100 us Long duration surges: >100 us
Supply voltage unbalance (Under normal operating conditions)	10 minute mean rms values of the negative phase sequence component/positive phase sequence component <ul style="list-style-type: none"> • $\leq 2\%$ during 95% each period of one week

Continued on next page

Compliance limits (continued)

The table below indicates the limit numbers or range of values required for each parameter to pass Voltage (QOS) compliance and satisfy EN50160 standard.

Parameter	Limits for QOS Compliance to Pass
Un = Low Voltage (LV) Supply nominal voltage, upper limit 1kV Uc = Medium Voltage (MV) Supply Characteristics - declared voltage, range 1kV to 35kV	
Harmonic voltage (Under normal operating conditions)	10 minute mean rms values Individual Harmonic voltage up to the 25th shall be \leq the value of Un given under Harmonic Compliance Limits (see table below) during 95% of one week • $\leq 8\%$ THD (THD up to the 40th) ≤ 8
Interharmonic voltage	Individual Interharmonic voltage up to the 24th-25th shall be $<$ the value of Un given under Interharmonic Compliance Limits (see table on page 7-28) during 95% of one week • $< 8\%$ TID (TID up to the 39th/40th)
Mains signalling voltage on the supply voltage	3 second mean of signal voltages compared against the Meister curve

Harmonic compliance limit values

The general approach of EN50160 is to express all voltage characteristics by reference to the nominal voltage or declared voltage, as appropriate. The table below indicates the Harmonic Compliance Limit values in relation to the nominal voltage.

Harmonic Number	Limit
DC	
2	2.0%
3	5.0%
4	1.0%
5	6.0%
6 thru 24 (all even nos.)	0.5%
7	5.0%
9	1.5%
11	3.5%
13	3.0%
15	0.5%
17	2.0%
19	1.5%
21	0.5%
23	1.5%
25	1.5%

Continued on next page

Interharmonic compliance limit values

The general approach of EN50160 is to express all voltage characteristics by reference to the nominal voltage or declared voltage, as appropriate. The table below indicates the Interharmonic Compliance Limit values in relation to the nominal voltage.

Interharmonic Group Number	Limit
DC-1	5.0%
1-2	4.8%
2-3	4.6%
3-4	4.4%
4-5	4.2%
5-6	4.0%
6-7	3.8%
7-8	3.6%
8-9	3.4%
9-10	3.2%
10-11	3.0%
11-12	2.8%
12-13	2.6%
13-14	2.4%
14-15	2.2%
15-16	2.0%
16-17	1.8%
17-18	1.6%
18-19	1.4%
19-20	1.2%
All other groups	1.0%

Event Statistics

EN50160 DISDIP

The EN50160 DISDIP (distribution of dips) table is based upon the event statistics calculated by EN50160. It includes the UNPEDE DISDIP Statistics and the table for Transient Overvoltages. UNPEDE DISDIP data is collected and saved on a weekly basis with the counts reset as the final save occurs. If additional data is detected for an evaluation period after that period has been saved, that internal data is retrieved and updated.

UNPEDE DISDIP statistics table

RMS variations shown in the UNPEDE DISDIP table is a filtered version of the Event list. The DISDIP table includes those events of rms variation type (sags, swells, and interruptions).

From the Voltage Compliance Report screen, press **DISDIP Table**. The UNPEDE DISDIP statistics table appears as shown below.

Depth (%)		Duration							
From	To <	msec	sec	sec	sec	sec	sec	min	min
		10<100	0.1<0.5	0.5<1	1<3	3<20	20<60	1<3	>3
Dips									
0	10	85	0	16704	0	49024	1	19205	16784
10	15	0	0	0	96	0	0	0	0
15	30	0	16	105	110	110	0	0	0
30	60	0	0	0	116	101	0	0	54752
60	99	85	0	16704	0	49024	1	19205	16784
Interruptions									
99	100	0	0	0	96	0	0	0	0
Temporary Overvoltages									
110	120	0	16	105	110	110	0	0	0
120	140	0	0	0	116	101	0	0	55744
140	160	85	0	16704	0	49024	1	19205	16784
160	200	98	0	0	96	0	0	0	0
200		0	16	105	110	110	0	0	0

HDPQ-653

RMS Event Count: The table shows rms variations of specified range of magnitude and duration, also called bins. For example, an rms variation with a magnitude of 80-90% of nominal and 1-5 cycles in duration is one bin, whereas 80-90% and 10-30 cycles is another, 70-80% and 10-30 cycles is another, and so on. Each time that the characteristics of an rms variation match the criteria of the bin, the counter is incremented. RMS phenomena are typically found in bin groupings such as:

- DIPS - classified in 5 Magnitudes x 8 Durations
- Interruptions - classified in 1 Magnitude x 8 Durations
- Temporary Overvoltages - classified in 5 Magnitudes x 8 Durations

Continued on next page

**UNIPEDE
DISDIP
statistics table
(continued)**

The DISDIP table also includes those events of Transient type. From the UNIPEDE DISDIP statistics table, press **Transient** to display data for Transient Overvoltage as shown below.

Transient Overvoltage		Counts
110	120	0
120	140	0
140	160	0
160	200	116
200		101

HDPQ-654

Transient Event Count: Transient phenomena are typically found in bin groupings such as:

- Transient Overvoltage - classified in 5 Magnitudes x 1 Count

Min/Max Table for Power Frequency and RMS Voltage

Min/Max table The Min/Max table displays the minimum and maximum values for Power Frequency and RMS Voltage along with the time and date of occurrence. Maximum phase values of Rapid Voltage Change, Flicker, Supply Voltage Unbalance, and Harmonic are also displayed along with time and date of occurrence.

From the Voltage Compliance Report screen, press **Min/Max**. Page 1 of the Min/Max table appears as shown below.

	Min	Max
Power Frequency - V Unbalance (52/51)	1	0
	19:00:00 Dec 31, 1969	15:21:20 Jun 4, 1970
Magnitude of Supply Voltage - Vrms	1.4013e-45	0
	19:00:00 Dec 31, 1969	22:08:00 Jul 27, 2105

Max Values	Phase A	Phase B	Phase C
Rapid Vrms Change	0	1.4013e-45	1.8746e-38
	19:00:00 Dec 31, 1969	19:00:01 Dec 31, 1969	19:03:13 Dec 31, 1969
Flicker (pft)	0	0	5.60519e-45
	15:17:04 Jun 4, 1970	07:48:52 Dec 10, 2004	19:00:00 Dec 31, 1969

HDPQ-656

Harmonic#	Phase A	Phase B	Phase C
THD	0	2.38221e-44	2.38221e-44
	19:34:08 Mar 6, 1970	19:34:08 Mar 6, 1970	14:54:08 Sep 28, 1970
2	0	27.2112	0
	19:00:00 Dec 31, 1969	19:00:00 Dec 31, 1969	19:00:02 Dec 31, 1969
3	12.6197	0	1
	07:26:56 Oct 5, 2003	19:00:00 Dec 31, 1969	19:00:00 Dec 31, 1969
4	0	0	0
	19:00:00 Dec 31, 1969	07:26:56 Oct 5, 2003	11:12:24 Jan 30, 2106
5	1	0	405
	19:00:00 Dec 31, 1969	07:26:56 Oct 5, 2003	17:43:28 Jul 27, 2005

HDPQ-657

Press the next pages to display the rest of the table values and view Harmonic values up to order no. 25.

Energy & Demand Report

Energy & Demand report interface

HDPQ Xplorer gives you the option to view the demand and energy report. The report list, as shown below, helps you monitor and manage energy consumption including utility costs. The instrument lists the report data files (.ddb), arranged in order of date and time they were recorded

From the Event Data & Reports menu, press **Energy & Demand Report**.

Cycle Start Date	Days In Cycle	Days Into Cycle	Daily	Weekly	Monthly
May 01, 2014 01:00:00 AM	31	0			
May 01, 2014 01:00:00 AM	31	1	✓		
May 01, 2014 01:00:00 AM	31	7		✓	
May 01, 2014 01:00:00 AM	31	31			✓

HDPQ-662

Use the function keys at the bottom of the screen to select Demand or Energy report for viewing. Each report entry is identified by a general heading indicating the following:

Cycle Start Date - specifies the date and time of the beginning of the billing interval cycle.

Days In Cycle - refers to the specific number of days that make up a billing cycle.

For example, the number of days in cycle typically range from 25 to 31 days, after which a new billing cycle begins.

Days Into Cycle - refers to the number of days of recorded usage from the cycle start date. This number is calculated into your billing rate to date (prior to the end of the billing cycle).

For example, suppose a billing cycle starts on the 1st of the month and ends on the 31st of the month. On the 10th calendar date, you are 10 days into a 31-day billing cycle.

Continued on next page

**Energy &
Demand report
interface
(continued)**

You have the ability to select from the following interval schedules on how often you want the instrument to monitor energy consumption and generate report files:

Daily - when enabled, monitors data in 24-hour cycle and then starts a new report file. The instrument will append the filename for data collected every 24 hours.

Weekly - when enabled, monitors data in 7-day cycle and then starts a new report file. The instrument will append the filename for data collected every 7 days.

Monthly - when enabled, monitors data in 31-day cycle and then starts a new report file. The instrument will append the filename for data collected every 31 days.

NOTE: Data monitoring will end when memory is full or when monitoring is stopped manually.

Harmonics Statistics Report

Harmonics statistics report interface

Allows you to set up a harmonic statistics report, based on the 3-second data calculating the 95 and 99% values per IEC 61000-4-7 and IEEE 519.

From the Event Data & Reports menu, press **Harmonics Statistics Report**.

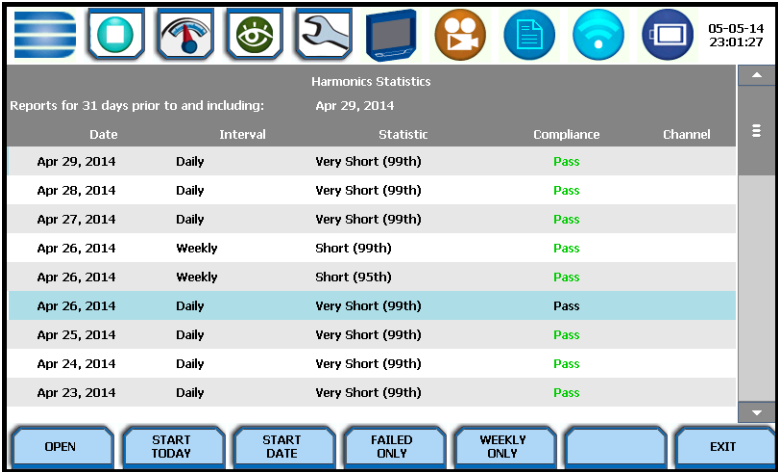

HDPQ-663

Function keys

Use the function keys at the bottom of the screen to set up the report.

Open - opens the selected harmonic report and displays the report on screen. The soft key below toggles between Line-to-Line or Line-to-Neutral, which changes the report parameters from A-B, B-C, C-A to AV, BV, CV.

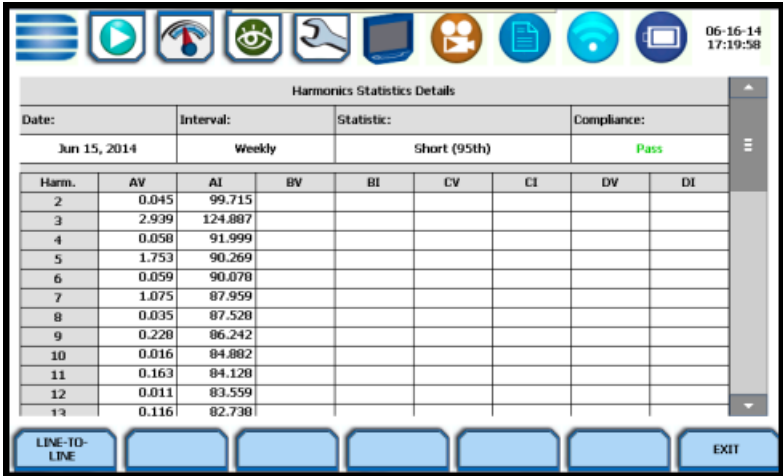

HDPQ-664

Continued on next page

**Function keys
(continued)**

Start Today - refreshes the current screen with 31 days of reports starting with today's date and working backwards.

Start Date - refreshes the current screen with 31 days of reports starting with the specified date and working backwards. Sample screen below appears, use it to specify the calendar year, month and date from which you want to view 31-days worth of harmonics statistics report.

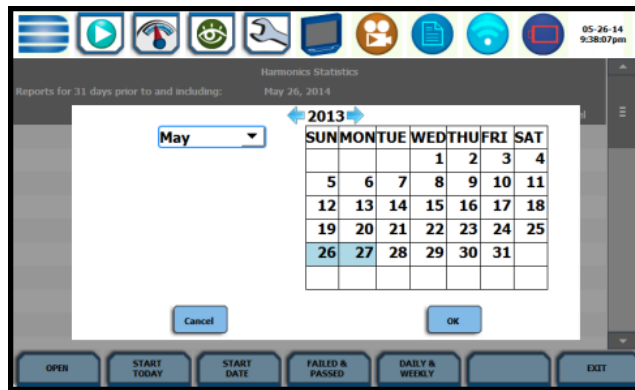

HDPQ-665

- Press **OK** to save any date changes made and return to the Harmonics Statistics Reports screen.
- Press **Cancel** to return to the Harmonics Statistics Reports screen without saving any changes.

Failed Only - refreshes the current screen showing only those reports with a "Fail" status. If "Failed Only" is already showing, then the button "Failed & Passed" is displayed. Pressing this button refreshes the current screen to show all all failed and passed reports.

Weekly Only - refreshes the current screen showing only the weekly reports. If "Weekly Only" is already showing then the button "Daily & Weekly" is displayed. Pressing the button refreshes the current screen to show all daily and weekly reports.



HDPQ-665b

Exit - returns to the Event Data & Reports menu.

Mini-Report Viewer

Create and view mini-report

The Mini-Report Viewer allows you to save the monitoring setups and/or status into an xml report file. You can also save the active image on screen and append it to the report as visual aid. Information in alphanumeric format is saved as .xml file while graphical information is saved as .bmp file.

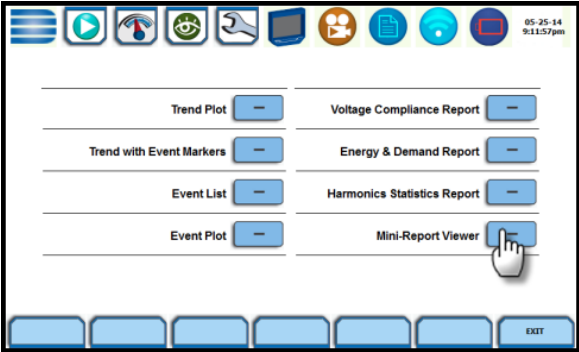
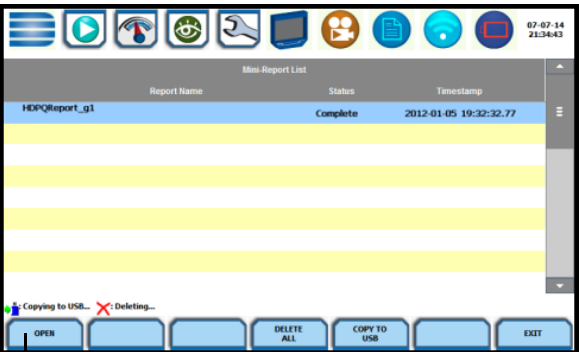
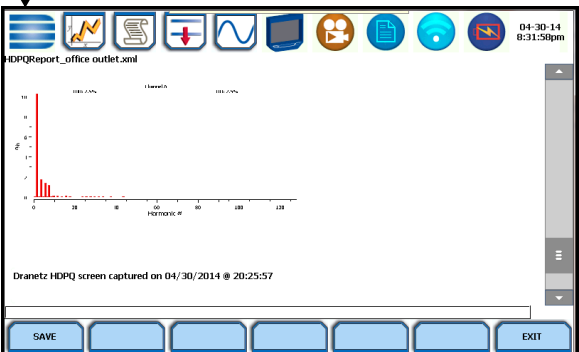
Action...	Result...
<p>STEP 1: From the Event Data & Reports menu, press Mini-Report Viewer.</p>	 <p>HDPQ-601</p>
<p>STEP 2: The Mini-Report Viewer brings up the list of active or previously saved mini-report(s) available. Select the report that you want to view, delete or save to an external USB flash drive.</p> <p>Use the Open key to view the report to the full size of the LCD display, with the taskbar on top remaining active and viewable.</p>	 <p>HDPQ-667</p>
<p>The Copy to USB key allows you to save the report file to an external USB device. Make sure that there is a flash drive inserted in the instrument's USB slot. Graphics are saved as image in .bmp format while alphanumeric content is saved as .xml file. Open the file with the xml extension using a web browser. Then select all by clicking and dragging the entire report and copy. You can then paste the contents into a Word document for editing.</p>	 <p>HDPQ-668</p>

Mini-report setup and capture

The Mini-Report Capture icon located at the middle of the HDPQ Xplorer front panel (below the LCD panel) allows you to save the active screen image to a Report File that is open. It appends the saved image to the open or active mini-report. If there is no report open, the instrument automatically creates a new mini-report file named after the site name augmented by a running counter.



Pressing the Mini-Report Capture icon will bring up the Mini-Report Start menu. This allows you to create a new report, if there is no active report open.



HDPQ-669

Use the Snapshot icon located at the leftmost side of the instrument's front panel to append an active screen image to an open report file, or copy the image separately as a stand-alone file (snapshot). Graphics are saved as an image in .bmp format.

Use the Mini-Report Capture icon located at the middle of the instrument's front panel to append an active screen image to an open report file. If there is no report open, the Mini-Report Start menu is displayed. Use this screen interface to create a new report by entering a report name and selecting a report template. Press OK when done or Cancel to disregard creation of a new mini-report. After a report is open, pressing it a second time allows you to close the report list.

NOTE: On remote VNC connection, keyboard shortcut keys F1 activates the Snapshot button and F2 activates the Mini-Report Capture function.

A P P E N D I X A



Optional Accessories

Overview

Introduction

This appendix lists the optional accessories for HDPQ Xplorer. It covers the hardware accessories available and the Dranetz software application required to view event data in a computer.

Topic	See Page
Hardware Accessories List & Descriptions	A-2
Software Accessories List & Descriptions	A-8

Ordering information

To order accessories, contact Dranetz Customer Service Department at:

Dranetz	Tel: (732) 287-3680
1000 New Durham Road	Tel: 1-800-372-6832
Edison, NJ 08818-4019 USA	FAX: (732) 248-1834
Attention: Customer Service	www.dranetz.com

Hardware Accessories List & Descriptions

Hardware accessories list

Accessory	Part Number
TR Series Current Probes	
TR-2501B, 100mA to 1.2A	118283-G1
TR-2500B, 10A to 500A	118284-G1
TR-2510B, 1A to 10A8-G1	118285-G1
TR-2520B, 100A to 3000A	118286-G1
TR-2530B, 20A to 300A	118287-G1
TR-2540B, 10A to 1000A	118288-G1
TR-2550B, 1A to 100A	118289-G1
PR Series Current Probes	
PR150/SP1B, 150A DC/AC (9VDC Wall Supply)	118290-G1
PR150/SP2B, 150A DC/AC (9VDC Battery)	118291-G1
PR1500/SP7B, 1500A DC/AC (9VDC Wall Supply)	118292-G1
PR1500/SP8B, 1500A DC/AC (9VDC Battery)	118293-G1
DRANFLEX XLB & MHB Series Probes	
<u>For Single Phase (XLB Series)</u>	
DRANFLEX3000XLB, 30A/300A/3000A, 24"	118433-G1
DRANFLEX3000XLB, 30A/300A/3000A, 36"	118434-G1
DRANFLEX3000XLB, 30A/300A/3000A, 48"	118435-G1
DRANFLEX6000XLB, 60A/600A/6000A, 24"	118439-G1
DRANFLEX6000XLB, 60A/600A/6000A, 36"	118440-G1
DRANFLEX6000XLB, 60A/600A/6000A, 48"	118441-G1
<u>For Three Phase (XLB Series)</u>	
DRANFLEX3003XLB, 30A/300A/3000A, 24"	118436-G1
DRANFLEX3003XLB, 30A/300A/3000A, 36"	118437-G1
DRANFLEX3003XLB, 30A/300A/3000A, 48"	118438-G1
DRANFLEX6003XLB, 60A/600A/6000A, 24"	118442-G1
DRANFLEX6003XLB, 60A/600A/6000A, 36"	118443-G1
DRANFLEX6003XLB, 60A/600A/6000A, 48"	118444-G1
<u>For Single Phase (MHB Series)</u>	
DRANFLEX300MHB, 3A/30A/300A, 6"	118430-G1
DRANFLEX300MHB, 3A/30A/300A, 8"	118431-G1
DRANFLEX300MHB, 3A/30A/300A, 12"	118432-G1

Continued on next page

Hardware accessories list (continued)

Accessory	Part Number
Current Probe Accessories	
For Probes PR150/SP1B and PR1500/SP7B AC Adapter, 9VDC (Universal Adapter) RR/PS/4A Adapter Cable (allows the connection of 4 PR series probes to a single 9VDC source)	PR9VUA RR/PS/4A
Cable Assembly, TR Type CT Extension, 5FT	TREXT5B
Cable Assembly, TR Type CT Extension, 10FT	TREXT10B
Cable Assembly, TR Type CT Extension, 15FT	TREXT15B
Cable Assembly, TR Type CT Extension, 20FT	TREXT20B
Cable Assembly, TR Type CT Extension, 25FT	TREXT25B
Cable Assembly, TR Type CT Extension, 30FT	TREXT30B
Voltage Probes	
Fuse Voltage Adapter, for single phase connection	FVA-1K1
Fuse Voltage Adapter, for three phase connection	FVA-1K4
Single Phase Measurement Cord, 115V, US	SPMEASCORD-US
Single Phase Measurement Cord, 250V, Europe	SPMEASCORD-EU
Single Phase Measurement Cord, 250V, UK	SPMEASCORD-UK
Single Phase Measurement Cord, 250V, Australia	SPMEASCORD-AU
Communications Accessories	
Ethernet Cable, Patch, CAT 5, 10 FT	ETH-CABLE
Ethernet Cable, Crossover, CAT 5, 10 FT	ETHX-CABLE
USB, Flash Drive, 8 Gbytes	USB-FLASH
USB to Bluetooth 2.1 Adapter - Class 1	USB-BLUETOOTH
GPS Receiver	GPS-HDPQ
GPS Magnetic Mount Antenna	GPSMA-HDPQ
GPS Receiver and Magnetic Mount Antenna	GPSMAKIT-HDPQ
Miscellaneous Hardware	
Weather Resistant Enclosure, US Weather Resistant Enclosure, Euro	ENCL-HDPQ-US ENCL-HDPQ-EU
Soft Carrying Case	SCC-HDPQ
Rugged Shipping Case	RSC-HDPQ
Battery Pack, 9.6V, 2.2Ah	BP-HDPQ
Phase Power Cable, US Phase Power Cable, EU	PPC-US PPC-EU

Continued on next page

Hardware Accessories List & Descriptions, continued

**Hardware
accessories list
(continued)**

Accessory	Part Number
Dranetz Reference Publications	
Field Handbook for Electrical Energy Management	HB114415
Field Handbook for Power Quality Analysis	HB114414-S
Power Quality Analysis Textbook	HB114416

Current probes Several Dranetz current probes, the TR (B Series) probes and PR (B Series) probes, can be used with the HDPQ Xplorer. HDPQ Xplorer also supports the DRANFLEX (XLB and MHB Series) probes. Refer to Chapter 2 for actual photos of these probes.

TR-2501B, TR-2500B, TR-2510B, TR-2550B: These probes models will measure rms currents from 100mA to 1.2A, 10A to 500A, 1A to 10A, and 1A to 100A respectively. They plug directly into any of the current inputs on the top panel of the instrument.

TR-2530B, TR-2540B, TR-2520B: These probe models will measure rms currents in ranges of 20A to 300A, 10A to 1000A, and 100A to 3000A respectively. They plug directly as well into any of the current inputs on the top panel of the instrument.

PR B-Series Current Probes: The PR150/SP1B, PR150/SP2B, PR1500/SP7B and PR1500/SP8B current probes have been designed for accurate non-intrusive measurements of AC and DC current. PR150/SP1B and PR150/SP2B current probes measure currents in the range of 15A to 150A AC/DC. PR1500/SP7B and PR1500/SP8B probes measure currents in the range of 150A to 1500A AC/DC.

The PR150/SP1B and PR1500/SP7B current probes require an external 9V power supply and each probe can be powered by a separate adapter or by one adapter and an optional RR/PS/4A adapter cable which allows the connection of four (4) PR series probes to a single 9VDC source.

The PR150/SP2B, and PR1500/SP8B current probes are supplied with a 9V battery and will operate on battery power typically for approximately 75 hours of continuous operation.

DRANFLEX XLB Series Current Probes: DRANFLEX XLB Series has current probe models that allow current measurements in Single Phase circuit and in 3 Phase circuit.

DRANFLEX3000XLB are Single Phase current probes that allow current measurements in the range of 30 to 3000A full scale. These probes are available in three sizes: 24" probe length - conductor(s) up to 8" diameter; 36" probe length - conductor(s) up to 11" diameter; 48" probe length -conductor(s) up to 17" diameter.

DRANFLEX6000XLB also are Single Phase current probes that allow current measurements in the range of 60 to 6000A full scale. These probes are available in three sizes: 24" probe length - conductor(s) up to 8" diameter; 36" probe length - conductor(s) up to 11" diameter; 48" probe length -conductor(s) up to 17" diameter.

DRANFLEX3003XLB are 3 Phase current probes that allow current measurements in the range of 30 to 3000A full scale. These probes are available in three sizes: 24" probe length - conductor(s) up to 8" diameter; 36" probe length - conductor(s) up to 11" diameter; 48" probe length - conductor(s) up to 17" diameter.

Continued on next page

Current probes (continued) DRANFLEX6003XLB also are 3 Phase current probes that allow current measurements in the range of 60 to 6000 A full scale. These probes are available in three sizes: 24" probe length - conductor(s) up to 8" diameter; 36" probe length - conductor(s) up to 11" diameter; 48" probe length -conductor(s) up to 17" diameter.

DRANFLEX MHB Series Current Probes: DRANFLEX300MHB are Single Phase current probes that allow current measurements in the range of 3 to 300A full scale. These probes are available in three sizes: 6" probe length - conductor(s) up to 2" diameter; 8" probe length - conductor(s) up to 2.75" diameter; 12" probe length - conductor(s) up to 4" diameter.

Voltage probes Fuse Voltage Adapter: Two accessory kits available: FVA-1K1 and FVA-1K4. FVA-1K1 is used for single voltage measurement input. It contains one fuse voltage adapter and one measurement connecting cable (Black) 50 cm in length. FVA-1K4 is used for three phase and neutral voltage measurement inputs. It contains four voltage adapters and four measurement connecting cables 50 cm in length (all Black with different color wire markers to identify which phase or circuit wire each is connected to).

Single Phase Measurement Cord: Allows measurement of a single phase circuit using a standard AC outlet 115V for US and 250V for European, UK, and Australian countries.

External memory device USB Flash Drive: HDPQ Xplorer supports the use of a USB flash drive in its native format, without the need for any adapter. Dranetz USB flash drive with memory capacity of 8GB, P/N USB-FLASH, is available for purchase as an optional accessory.

Communication interface Allows connection to the HDPQ Xplorer mainframe via the Ethernet cable.

Ethernet Cable: Two types of ethernet cables are available to connect the HDPQ Xplorer to the computer via the ethernet port: Ethernet Cable, Patch, CAT 5, 10 FT (P/N ETH-CABLE) and Ethernet Cable, Crossover, CAT 5, 10 FT (P/N ETHX-CABLE).

Bluetooth external adapter USB to Bluetooth 2.1 Adapter - Class 1: The Dranetz Bluetooth external adapter comes as a standard accessory on the HDPQ Xplorer, Xplorer-400 and Guide. While it comes as an optional accessory for the HDPQ Visa.

GPS receiver GPS can access time from a GPS receiver using the following accessories:

GPS Receiver (P/N GPS-HDPQ)

GPS Magnetic Mount Antenna (P/N GPSMA-HDPQ)

GPS Receiver and Magnetic Mount Antenna (P/N GPSMAKIT-HDPQ)

Miscellaneous hardware

Weather Resistant Enclosure (P/Ns ENCL-HDPQ-US, ENCL-HDPQ-EU): This weatherproof enclosure is designed to keep the HDPQ Xplorer and its cable connections in place. It is made of fiber glass and is intended for indoor and outdoor use. This enclosure is sturdy, lightweight, corrosion-resistant. It is able to withstand windblown dust, rain, splashing water, and ice formation.

Soft Carrying Case (P/N SCC-HDPQ): Heavy-duty, padded, nylon carrying case. Includes pockets for cable set, current probes, and other accessories.

Reusable Shipping Container (P/N RSC-HDPQ): Lockable, high-impact plastic case with foam insulation for protecting the instrument during shipping.

Battery Pack (P/N BP-HDPQ): NiMH (Nickel Metal Hydride) battery cells are used in HDPQ Xplorer. See Appendix C Battery Specifications and Replacement Procedure.

Dranetz reference publications

Field Handbook for Electrical Energy Management (P/N HB114415): This reference handbook provides a comprehensive guide for information related to conducting a thorough energy audit, power distribution analysis, and methods of remedying inefficiencies of energy management.

Field Handbook for Power Quality Analysis (P/N HB114414-S): This handbook is divided into six sections containing step-by-step instructions for discovering and solving complex power quality problems. Example waveforms and case studies are included.

Power Quality Analysis Textbook (P/N HB114416): This hard-cover book contains ten chapters covering topics such as: what are PQ phenomena, picking the right tools for the job, how to measure safely, how to analyze the data collected and turn it into answers, mitigation techniques for minimizing PQ problems, and much more. Case studies to illustrate PQ concepts along with an extensive glossary on definitions, relevant industry standards, and references are included.

Software Accessories List & Descriptions

Software accessories list

Dran-View® is an optional viewer and data analysis software. Data sessions collected by the HDPQ Xplorer must first be transferred to a computer so that they can be archived and/or viewed using Dran-View.

The software version for use with the Dranetz HDPQ products is Dran-View V7.x. You are strongly advised to always keep the Dran-View and HDPQ Xplorer programs current with the latest version released by Dranetz.

NOTE: If you have a version other than Dran-View 7, you will need to upgrade to version 7 to be able to view HDPQ data files.

Dran-View 7 is available in two product types: the Dran-View Professional (Pro) which has a powerful feature set, and the Dran-View Enterprise which has even more features and functions available. The table below lists the part numbers for the corresponding Dran-View 7 product types:

Supports the following Dranetz products	Dran-View Product Type	
	Dran-View Professional (Pro)	Dran-View Enterprise
HDPQ Xplorer, Xplorer-400, Guide, Visa	DV7P-PX	DV7E-PX

Dran-View 7 application

Dran-View 7 is a Windows®-based software package that enables power professionals to simply and quickly visualize and analyze power monitoring data. Not only is it a snap to navigate, it delivers automated functionality, and incorporates powerful analytical capabilities and customizable options to meet the needs of each individual user. Dran-View is successfully used by thousands of customers around the world, and has become the industry-leading power management software tool.

Dran-View 7 is available in two types: the Professional (Pro) version and the Enterprise version.

Following are the features and highlights of the Dran-View 7 Pro:

- Simple user interface
- High speed file conversion
- Support for large data files
- Efficient file compression
- Rollable (rubberbanding) axis in diagrams, zoom, pan, etc.
- Unlimited undo / redo capability
- Built-in text editor

Continued on next page

**Dran-View 7
application
(continued)**

- Monitoring mode specific reports in both the automatic and custom mode
- Format templates for consistent formatting
- Timeplots/waveshape/magnitude-duration & DFT charts
- Rescue kit (repair data)
- Separate harmonic scaling for voltage, current, and power
- Automatic updates via the Internet
- Export Data to Excel

Following are the features and highlights of the Dran-View 7 Enterprise:

All the features of the Dran-View 7 Pro, plus:

- Multi-site presentation/report writing - supports presentation of many simultaneous data sets
- Multi-site mathematical formulas
- Additional advanced report writing modules
- Drag-and-drop user interface
- Customizable toolbars, menus and keyboard shortcuts
- Data removal
- Data aware notation text balloons in your charts
- Timeplot and harmonics calculations from waveshapes
- Images and photographs can be inserted
- Imports COMTRADE files (including data from protection relays)
- Imports PQ data from text/spreadsheets
- Snapshots to create print queues or restore program status
- Enhanced DFT features for selecting and analyzing harmonics

**Customer
service and
support**

For more information on the Dran-View software package, or for installation or operating assistance with the Dran-View software, please contact the Dranetz Customer Support at (732) 287-3680 or 1-800-372-6832.

This page intentionally left blank.

A P P E N D I X B



Technical Specifications

Overview

In this appendix The following specifications are covered in this appendix.

Topic	See Page
General	B-2
Interfaces	B-3
Measured Parameters	B-4
Computed Parameters	B-6
Parameter Settings in Each Monitoring Mode	B-10
Current Probe Specifications	B-12

General

Dimensions Size: 10" Width x 8" Height x 2.75" Depth (25.4 x 20.3 x 7.00 cm)

Weight: 4.2 pounds (1.9 kg)

Environmental Operating: 0 to 50 °C (32 to 122 °F)

Storage: -20 to 55 °C (4 to 131 °F)

Humidity: 10% - 90% non-condensing

Altitude 2000m (6560 ft) maximum

System Time Clock Crystal controlled. 1 second resolution.
Event time clock displays to 1 msec resolution
Time displayed in digital (12 or 24 hour) format
Accurate to 60 seconds per month.

USB Memory Device Dranetz 8GB USB flash drive available as optional accessory

Power Requirements Use external UL/CE approved battery charger with international plugs. Mechanical On/Off switch shuts unit down, but allows battery to continue to charge with switch in the Off position.

Voltage: 90-265V AC, 47/63 Hz

Consumption: 20 watts max

Field replaceable batteries: Approximately three (3) hours of continuous use while operating from a fully charged battery.

Input resistance Voltage input: 20 MΩ Line to Line

Current input: 400 kΩ

Installation Categories Mains supply: Installation Category II, Pollution Degree 2

Measurement voltage inputs: 1000 Vrms Maximum; Installation Category III, Pollution Degree 2

Interfaces

Display Type: WVGA wide screen color graphic, touch screen Liquid Crystal Display (LCD) with compact fluorescent (CCFL) backlighting. Programmable backlight time-out to reduce power consumption. Reactivates with touch.

Resolution: 360 x 240 dot matrix

Size: 3.60 inches high x 6.00 inches wide

Touch icons On the front panel of the instrument, there are three touch icons used to perform various functions i.e. take a Snapshot of the active screen, capture Mini-Reports and access Help screens. These icons cannot be activated with gloves on as they employ capacitive or touch technology. For remote VNC connection, keyboard shortcut keys F1,F2 and F3 are used to activate these functions remotely.

Alarm Audible alarm of short (approximately 0.1 second) or long (approximately 1 second) duration to call attention to an error condition or event trigger, respectively.

Communication Connect to the HDPQ Xplorer mainframe using either of the following:

- Ethernet IP Connection
- Wireless (WiFi) Network Connection
- Bluetooth Connection
- VNC Connection
- Modbus Connection

Measured Parameters

Voltage

Type: 4 full differential, DC coupled, galvanically isolated to 1kV

Channels A, B, C, D Input Range: 0-1000Vrms CAT III, 0-600 Vrms CAT IV

Input impedance: 20 M Ω , minimum, Input to Input

Crest factor: Maximum 2.0 at full scale

RMS Accuracy*:

$\pm 0.1\%$ of Reading, $\pm 0.05\%$ Full Scale, over 15KHz bandwidth

$\pm 0.1\%$ of Reading for $V > 60$ Vrms

RMS Variations Accuracy*: $\pm 0.2\%$ of Reading

Transient Input Range: 50 - 2000 Vpeak

Transient Accuracy: $\pm 10\%$ of Reading, $\pm 0.5\%$ Full Scale for Pulse widths $> 10\mu\text{s}$

Transient Duration: 2 μs minimum

CMMR: -80 dB

Sampling rate: 512 samples per cycle; rms computed on 1/2 cycle step

*Voltage accuracy range requires PLL synchronization 60-1000V, 30% Vthd or less

Current

Type: 4 full differential, DC coupled, galvanically isolated to 1kV

Channels A,B, C, D Input Range: 10 - 200% of Rated Probe Input (Dranetz probes)

Input impedance: 340k ohm minimum, Input to Input

Channels A,B,C, D crest factor: Maximum of 3 at full scale

RMS Accuracy:

$\pm 0.1\%$ of Reading $\pm 0.05\%$ Full Scale plus Probe Accuracy, 9KHz bandwidth (1 second rms readings)

Transient Input Range: 3 times Probe Rated Nominal Input (Dranetz probes)

Transient Accuracy: $\pm 10\%$ of Reading, $\pm 0.5\%$ Full Scale for Pulse widths $> 10\mu\text{s}$

Transient Duration: depends on probe bandwidth

CMMR: -80 dB

Sampling rate: 512 samples per cycle; rms computed on 1/2 cycle step

Probe Power per Channel: 20mA max at 3.3V

Phase	All channels are sampled simultaneously to preserve phase relationship. <u>Accuracy:</u> Voltage and Current phase accuracy dependent on Current Probe.
Power	Watts and PF accuracy dependent on type of current probe and amplitude level of signal of current <u>Accuracy (at measuring inputs):</u> $\pm 0.2\%$ of reading over ANSI C12.1 / C12.20 operating range
Frequency	User selectable based on nominal frequency selection. For Dranetz models HDPQ Xplorer, HDPQ Guide, HDPQ Visa: <ul style="list-style-type: none">• 30 - 70 Hz default, with up to 30% Vthd, 60-1000Vrms• 15 - 30 Hz <u>Accuracy:</u> ± 10 mHz of reading For Dranetz model HDPQ Xplorer-400: <ul style="list-style-type: none">• 30 - 70 Hz default, with up to 25% Vthd• 380 - 440 Hz (reduced accuracy with 32 samples/cycle) <u>Accuracy:</u> $\pm 0.2\%$ of reading
Environmental	All specifications are met over the operating range with influence factors as per IEC 61000-4-30 Class A.

Computed Parameters

Single Channel Parameters The computations below apply to single channel parameters.
Note that $\theta_V = \text{Phase Angle of Voltage}$, while $\theta_I = \text{Phase Angle of Current}$.

True Average Power Average of the instantaneous power samples taken as the product of voltage and current samples. Includes sign to indicate direction of power flow: positive (+) from source to load, negative (-) from load to source.

$$WATT = \frac{1}{N} \sum_{n=1}^N V_n I_n$$

where N = number of samples
V_n = Voltage at sample n
I_n = Current at sample n

Apparent Power Unsigned value calculated using the product of the rms values of the voltage and current.

$$VA = V_{RMS} I_{RMS}$$

Fundamental Apparent Power Unsigned value calculated using the product of the fundamental rms values of the voltage and current.

$$VA_{fund} = V_{fund} I_{fund}$$

Fundamental Power Signed value calculated using the product of the fundamental apparent power and the cosine of the phase angle between the fundamental frequency components of voltage with respect to current ($\theta = \theta_V - \theta_I$).

$$WATT_{fund} = VA_{fund} \cos \theta$$

Volt Ampere Reactive Signed value calculated using the product of the fundamental apparent power and the sine of the phase angle between the fundamental frequency components of voltage with respect to current ($\theta = \theta_V - \theta_I$).

$$VAR_{fund} = VA_{fund} \sin \theta$$

Continued on next page

True Power Factor

Calculated using the True Average Power divided by the Apparent Power. See Note below for sign information.

$$TPF = \left| \frac{WATT}{VA} \right|$$

Displacement Power Factor

Calculated using cosine of the phase angle between the fundamental frequency components of voltage with respect to current ($\theta = \theta_V - \theta_I$). See Note below for sign information.

$$DPF = |\cos \theta|$$

NOTE

The sign is the exclusive OR of the sign of the Watts and Vars. Note that for Power Factor, the words “Lead” and “Lag” are definitive. As far as the signs go, it is assumed that Lag (inductive) is plus and Lead (capacitive) is minus when energy is delivered to the load.

Quad	2		Quad	1
PF Lead	-		PF Lag	+
Watts	-		Watts	+
Vars	+		Vars	+
-----+-----				
Quad	3		Quad	4
PF Lag	+		PF Lead	-
Watts	-		Watts	+
Vars	-		Vars	-

In the code, this is implemented as:

Signum Watts: cosine θ

Signum Vars: sine θ

Signum PF: (Signum Watts) * (Signum Vars)

where signum denotes the positive or negative sign.

Source: The diagram above matches *Figure 9-26 Relationships Between Watts, Vars, and Volt-Amperes* found on page 228 of the Handbook for Electricity Metering, Ninth Edition, ©1992, Edison Electric Institute, Washington, D.C., USA.

Continued on next page

Totals

The computations below apply to three phase wye configuration.

Totals for split phase can be determined by eliminating phase C (i.e. split phase
 $WATT_{Tot} = WATT_A + WATT_B$)

Power Total

$$WATT_{Tot} = WATT_A + WATT_B + WATT_C$$

Fundamental Power Total

$$WATT_{Tot\ fund} = WATT_{A\ fund} + WATT_{B\ fund} + WATT_{C\ fund}$$

Fundamental Reactive Power Total

$$VAR_{Tot\ fund} = VAR_{A\ fund} + VAR_{B\ fund} + VAR_{C\ fund}$$

Apparent Power, Arithmetic Total

$$VA_{Arithmetic\ Tot} = VA_A + VA_B + VA_C$$

Apparent Power, Vector Total

$$VA_{Vector\ Tot} = \sqrt{WATT_{Tot}^2 + VAR_{Tot\ fund}^2}$$

Fundamental Apparent Power, Arithmetic Total

$$VA_{Arithmetic\ Tot\ fund} = VA_{A\ fund} + VA_{B\ fund} + VA_{C\ fund}$$

Fundamental Apparent Power, Vector Total

$$VA_{Vector\ Tot\ fund} = \sqrt{WATT_{Tot\ fund}^2 + VAR_{Tot\ fund}^2}$$

Continued on next page

True Power Factor, Arithmetic Total See Note on page B-7 for sign information.

$$TPF_{Arithmetic\ Tot} = \left| \frac{WATT_{Tot}}{VA_{Arithmetic\ Tot}} \right|$$

True Power Factor, Vector Total See Note on page B-7 for sign information.

$$TPF_{Vector-Tot} = \left| \frac{WATT_{Tot}}{VA_{Vector\ Tot}} \right|$$

Displacement Power Factor, Arithmetic Total See Note on page B-7 for sign information.

$$DPF_{Arithmetic\ Tot} = \left| \frac{WATT_{Tot}}{VA_{Arithmetic\ Tot\ fund}} \right|$$

Displacement Power Factor, Vector Total See Note on page B-7 for sign information.

$$DPF_{Vector\ Tot} = \left| \frac{WATT_{Tot\ fund}}{VA_{Vector\ Tot\ fund}} \right|$$

Parameter Settings in Each Monitoring Mode

Setup parameters

The following table lists the default settings for the threshold parameters in each monitoring mode.

Parameters	Standard Power Quality IEC / IEEE	Motor Current Inrush	Fault Recorder	Long-term Timed Recording	Continuous Data Logging	EN50160	Motor Quality	Energy Audit
RMS Variation								
High Limit	110%	120%	110%	Off	Off	110%	110%	110%
Low Limit	90%	Off	90%	Off	Off	90%	90%	90%
Very Low Limit	1% / 10%	Off	10%	Off	Off	1%	10%	Off
RMS Pre-trigger (cycles)	6	4	4	0	1	6	6	1
RMS In-Out Post-trigger (cycles)	60	200	100	0	2	6	6	8
RMS Out-In Post-trigger (cycles)	60	200	1000	0	2	6	6	8
Waveform Capture Pre-trigger (cycles)	2	4	4	0	1	2	2	1
Waveform Capture Post-trigger (cycles)	2	200	1000	10 (50 Hz); 12 (60 Hz) (snapshots)	2	2	2	8
Transients								
Absolute Instantaneous Peak	170%	350%	170%	Off	Off	170%	170%	Off
High Frequency	100%	Off	100%	Off	Off	100%	100%	Off
Cycle-by-cycle Waveshape Magnitude	10%	Off	10%	Off	Off	10%	10%	Off

Continued on next page

**Setup
parameters
(continued)**

The following table lists the default settings for the threshold parameters in each monitoring mode.

Parameters	Standard Power Quality IEC / IEEE	Motor Current Inrush	Fault Recorder	Long-term Timed Recording	Continuous Data Logging	EN50160	Motor Quality	Energy Audit
Transients (continued)								
Cycle-by-cycle Waveshape Duration (% of cycle)	10%	Off	10%	Off	Off	10%	10%	Off
Waveform Duration	7%	Off	7%	Off	Off	7%	7%	Off
Waveform Capture Trigger Response								
When Volts go out, record:	All Active Channels	Off	All Active Volt Channels	Off	Off	All Active Channels	All Active Channels	All Active Channels
When Amps go out, record:	Fault Amps Channels	Fault Amps Channels	Fault Amps Channels	Off	Off	Fault Amps Channels	Fault Amps Channels	Fault Amps Channels
Journal Intervals								
Volts	10 minutes	Off	Off	10 minutes	1 second	10 minutes	10 minutes	10 minutes
Amps	10 minutes	Off	Off	10 minutes	1 second	10 minutes	10 minutes	10 minutes
Power	10 minutes	Off	Off	10 minutes	1 second	10 minutes	10 minutes	10 minutes
Demand	15 minutes	Off	Off	15 minutes	Off	15 minutes	15 minutes	5 minutes
Energy	10 minutes	Off	Off	10 minutes	10 minutes	10 minutes	10 minutes	10 minutes
Harmonics	10 minutes	Off	Off	10 minutes	Off	10 minutes	10 minutes	10 minutes
Flicker (Pst)	10 minutes	Off	Off	10 minutes	Off	10 minutes	10 minutes	Off
Flicker (Plt)	2 hours	Off	Off	2 hours	Off	2 hours	2 hours	Off
Characterizer Mode	IEC 4-30 / IEEE 1159	None	None	IEEE 1159	None	IEC 61000-4-30	IEEE 1159	None

**Numbers are in percent of nominal unless otherwise specified.*

Current Probe Specifications

- Probe guidelines** To achieve the rated accuracies, follow these guidelines:
- The conductor must be at a right angle to the probe
 - The conductor must be centered in the probe core
 - The jaw contact surfaces must be clean and properly aligned.

TR Series probes

TR SERIES PROBE SPECIFICATIONS

Type: Clamp-on, AC

Installation Category: 600 VRMS, CAT III, Pollution Degree 2

Model	Range		Amplitude Accuracy ±	Phase Accuracy +/-	Frequency Range	Maximum Conductor Size
TR2500B	10A to 500A rms	100A to 500A	1%	1.5°	40Hz to 5KHz	50mm dia.
		10A to 100A	2%	3°		
TR2501B	100mA to 1.2A rms	1.2A	1.5%	2°	40Hz to 5KHz	15mm dia.
		100mA	2%	3°		
TR2510B	1A to 10A rms	5A to 10A	1.2%	1.5°	40Hz to 5KHz	15mm dia.
		100mA	1.2%	1°		
TR2520B	100A to 3000A rms	1000A to 3000A	0.5%	0.5°	40Hz to 5KHz	72mm dia.
		300A to 1000A	0.75%	0.75°		
		100A to 300A	1.5%	1.5°		
TR2530B	20A to 300A rms	50A to 300A	1%	0.5°	30Hz to 5KHz	54mm dia.
		20A to 50A	1.5%	0.6°		
TR2540B	10A to 1000A rms	100A to 1000A	1%	0.4°	30Hz to 5KHz	54mm dia.
		10A to 100A	1.5%	0.5°		
TR2550B	1A to 100A rms	10A to 100A	1%	2.5°	40Hz to 10KHz	15mm dia.
		1A to 10A	2%	5°		

PR Series probes

PR SERIES PROBE SPECIFICATIONS

Type: Clamp-on, AC/DC

Installation Category: 600 VRMS, CAT III, Pollution Degree 2

Model	Range	Amplitude Accuracy ±	Phase Accuracy +/-	Frequency Range	Maximum Conductor Size
PR150B	15A to 150A	1%	3°	DC to 5KHz	52mm dia.
PR1500B	15A to 1500A	1%	1°	DC to 5KHz	52mm dia.

**DRANFLEX
300MHB Series
probes**

DRANFLEX 300MHB SERIES PROBE SPECIFICATIONS

Type: Flexible

Installation Category: 1000 VRMS, CAT III, Pollution Degree 2

Model	Range		Amplitude Accuracy ±	Phase Accuracy +/-	Frequency Range	Maximum Conductor Size
DRANFLEX 300MHB 6/8/12	0.3A to 300A (3 ranges)	0.3A to 3A	1% rdg, ±0.1A	1°	25Hz to 75KHz	50/70/100 mm dia.
		0.3A to 3A	1% rdg, ±0.1A			
		30A to 3000A	1% rdg, ±0.5A			

**DRANFLEX
3000XLB/
6000XLB Series
probes**

DRANFLEX 3000XLB/6000XLB SERIES PROBE SPECIFICATIONS

Type: Flexible

Installation Category: 1000 VRMS, CAT III, Pollution Degree 2

Model	Range		Amplitude Accuracy ±	Phase Accuracy +/-	Frequency Range	Maximum Conductor Size
DRANFLEX 3000XLB DRANFLEX 3003XLB 24/36/48	3A to 3000A (3 ranges)	3A to 30A	1% rdg, ±0.1A	1°	10Hz to 10KHz	200/280/430 mm dia.
		30A to 300A	1% rdg, ±0.1A			
		300A to 3000A	1% rdg, ±1A			
DRANFLEX 6000XLB DRANFLEX 6003XLB 24/36/48	6A to 6000A (3 ranges)	6A to 60A	1% rdg, ±0.1A	1°	10Hz to 10KHz	200/280/430 mm dia.
		60A to 600A	1% rdg, ±0.1A			
		600A to 6000A	1% rdg, ±1A			

This page intentionally left blank.

A P P E N D I X C



Battery Specifications and Replacement Procedure

Overview

Introduction The internal battery pack used in HDPQ Xplorer functions as the primary power source and UPS. Always charge the battery fully before using the unit. HDPQ Xplorer will fully charge its internal battery in four (4) hours.

HDPQ Xplorer uses a non-volatile flash memory for backup that is not operator replaceable. Data will not be lost if the battery pack is removed. The flash memory will store data temporarily.

In this appendix The following topics are covered in this appendix.

Topic	See Page
Battery Specifications	C-2
Battery Safety Precautions	C-3
Battery Pack Replacement	C-4

Battery Specifications

Battery pack

Type: Sealed, rechargeable NiMH (Nickel Metal Hydride) cells.

Location: Battery compartment on the rear of the unit.

Number of batteries in pack: 8

Voltage: 9.6 Vdc

Capacity: 2.2 Ah

Charging: A depleted battery pack can be recharged in four (4) hours whether the unit is on or off. While charging, the taskbar displays a battery icon indicating the percent of battery charge.

Length of operation: Approximately four (4) hours of continuous use while operating from a fully charged battery.

Suggested replacement interval: Two years

Part Number: BD-HDPQ (118348-G1)

NOTE: The length of time that the HDPQ Xplorer can operate on the battery pack degrades over the life of the batteries and the number of charge/discharge cycles.

Battery Safety Precautions

WARNING DO NOT intentionally short circuit the battery pack. The batteries are capable of providing hazardous output currents if short circuited. HDPQ Xplorer is equipped with an internal battery charger circuit. Do not attempt to charge the batteries with an external charger other than the Dranetz battery charger, since improper charging could cause battery explosion.

ADVERTENCIA NO ponga intencionalmente la batería en cortocircuito. Las baterías son capaces de proporcionar corrientes de salida peligrosas si están en cortocircuito. La HDPQ Xplorer está equipada con un circuito interno cargador de baterías. No intente cargar las baterías con un cargador externo que no sea el cargador de baterías Dranetz, puesto que la carga indebida podría hacer que explote la batería.

AVERTISSEMENT NE PAS court-circuiter délibérément le bloc-batterie. Lors d'un court-circuit, les batteries risquent d'émettre des courants effectifs dangereux. HDPQ Xplorer possède un circuit de chargeur de batterie intégré. Ne pas tenter de charger les batteries au moyen d'un chargeur externe autre que le chargeur de batterie Dranetz, car un rechargement fautif pourrait entraîner l'explosion de la batterie.

WARNUNG Die Batterien dürfen NICHT kurzgeschlossen werden. Im Falle eines Kurzschlusses können die Batterien lebensgefährliche Ausgangsströme leiten. HDPQ Xplorer ist mit einem internen Batterieladegerät ausgestattet. Die Batterien sollten nur mit dem Ladegerät von Dranetz geladen werden. Die Verwendung eines externen Ladegeräts kann zu einer Explosion der Batterien führen.

Safety precautions Observe the following precautions when inspecting or replacing the battery pack:

- Do not attempt to replace individual batteries of the pack or substitute other battery types.
- Do not dispose of battery in fire.
- Dispose of a used battery promptly in accordance with local Environmental Protection Agency (EPA) regulations.
- Visually inspect the battery pack for corrosion.

The batteries have a safety pressure vent to prevent excessive gas build-up and corrosion indicates that venting has occurred. Possible causes of venting are: a defective charger, excessive temperature, excessive discharge rate, or a defective cell.

If corrosion is excessive, the battery pack may require replacement (contact Dranetz Customer Service Department).

Battery Pack Replacement

Introduction The HDPQ Xplorer contains an easily replaceable internal battery pack. See Appendix D for ordering information.

WARNING Replace with Dranetz NiMH battery pack BD-HDPQ (118348-G1) only.

ADVERTENCIA Reemplace con batería Dranetz NiMH BD-HDPQ (118348-G1) solamente.

AVERTISSEMENT Remplacer par la batterie Dranetz NiMH BD-HDPQ (118348-G1) exclusivement.

WARNUNG Nur mit Dranetz NiMH BD-HDPQ (118348-G1) Batteriesatz auswechseln.

NOTE During normal operation, the battery pack will be slightly warm to the touch.

Procedure Follow these steps to replace the battery pack.

Step	Action
1	Switch the HDPQ Xplorer power button to off.
2	Turn off power to the circuit being measured.
3	Disconnect voltage and current probes from the circuit and the HDPQ Xplorer's rear panel.
4	On the bottom of the HDPQ Xplorer, push the tab to release the battery cover. Refer to the diagram shown on page C-5.
5	Remove the cover.
6	Pull up on removal strap and remove battery pack.
7	Insert the new pack into the compartment making sure to observe polarity markings.
8	Replace the cover and press down until it latches closed.
9	Discard the old battery pack in accordance with Environmental Protection Agency (EPA) regulations.
10	Switch the HDPQ Xplorer power button to on.

Battery removal diagram

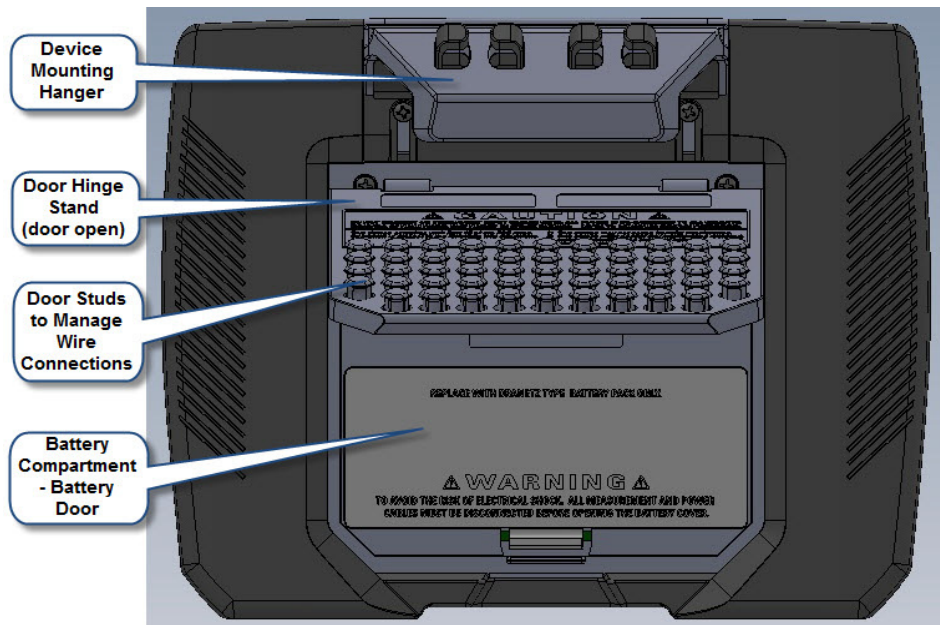

This page intentionally left blank.

A P P E N D I X D



User Replaceable Parts List

Introduction The following parts are easily replaced by the operator and do not require special tools or access to the interior of the unit.

To order parts Call Dranetz Customer Service at (732) 287-3680 or 1-800-372-6832 to order any of the following parts.

Parts List

Part Description	Part Number
AC Adapter with Universal Plugs	PS-HDPQ
Battery Door	118308-G1
Battery Pack	BP-HDPQ
Rubber Boot, Blue	118315-G1
Voltage Cable Assembly, 4 Pair w/ Alligator Probes (See below for separate parts)	VCS-HDPQ
Hanger, Blue	118312-G1

Measurement cable set, parts list

Part Description	Quantity	Part Number
Measurement Channel Cable Assembly	4	114013-G1
Alligator Clip, 4MM Plug-on, Black	4	901794
Measurement Connecting Cables, Black	4	901963
Measurement Connecting Cables, White	4	900370
Wire Marker, Voltage Kit, Snap-On	1	WMV-KIT
Wire Marker, Current Kit, Snap-On	1	WMI-KIT
Alligator Clip, 4mm, Plug-On, White	4	901962
Cable Pouch	1	116043-G1

This page intentionally left blank.

A P P E N D I X E



Common Circuit Connections

Overview

Who should read this section

If you are making power measurements, follow these diagrams so that your ABC values are calculated correctly.

WARNING

Death, serious injury, or fire hazard could result from improper connection of this instrument. Read and understand this manual before connecting this instrument. Follow all installation and operating instructions while using this instrument.

Connection of this instrument must be performed in compliance with the National Electrical Code (ANSI/NFPA 70-2014) and any additional safety requirements applicable to your installation.

Installation, operation, and maintenance of this instrument must be performed by qualified personnel only. The National Electrical Code defines a qualified person as “one who has the skills and knowledge related to the construction and operation of the electrical equipment and installations, and who has received safety training on the hazards involved.”

Qualified personnel who work on or near exposed energized electrical conductors must follow applicable safety related work practices and procedures including appropriate personal protective equipment in compliance with the Standard for Electrical Safety Requirements for Employee Workplaces (ANSI/NFPA 70E-2012) of USA and any additional workplace safety requirements applicable to your installation.

ADVERTENCIA

Una conexión incorrecta de este instrumento puede producir la muerte, lesiones graves y riesgo de incendio. Lea y entienda este manual antes de conectar. Observe todas las instrucciones de instalación y operación durante el uso de este instrumento.

La conexión de este instrumento debe ser hecha de acuerdo con las normas del Código Eléctrico Nacional (ANSI/NFPA 70-2014) de EE. UU., además de cualquier otra norma de seguridad correspondiente a su establecimiento.

La instalación, operación y mantenimiento de este instrumento debe ser realizada por personal calificado solamente. El Código Eléctrico Nacional define a una persona calificada como "una que esté familiarizada con la construcción y operación del equipo y con los riesgos involucrados."

Continued on next page

El personal cualificado que trabaja encendido o acerca a los conductores eléctricos energizados expuestos debe seguir prácticas y procedimientos relacionados seguridad aplicable del trabajo incluyendo el equipo protector personal apropiado en conformidad con el estándar para los requisitos de seguridad eléctricos para los lugares de trabajo del empleado (ANSI/NFPA 70E-2012) de los E.E.U.U. y cualquier requisito de seguridad adicional del lugar de trabajo aplicable a su instalación.

AVERTISSEMENT Si l'instrument est mal connecté, la mort, des blessures graves, ou un danger d'incendie peuvent s'en suivre. Lisez attentivement ce manuel avant de connecter l'instrument. Lorsque vous utilisez l'instrument, suivez toutes les instructions d'installation et de service.

Cet instrument doit être connecté conformément au National Electrical Code (ANSI/NFPA 70-2014) des Etats-Unis et à toutes les exigences de sécurité applicables à votre installation.

Cet instrument doit être installé, utilisé et entretenu uniquement par un personnel qualifié. Selon le National Electrical Code, une personne est qualifiée si "elle connaît bien la construction et l'utilisation de l'équipement, ainsi que les dangers que cela implique".

Le personnel qualifié qui travaillent dessus ou s'approchent des conducteurs électriques activés exposés doit suivre des pratiques en matière et des procédures reliées par sûreté applicable de travail comprenant le matériel de protection personnel approprié conformément à la norme pour des conditions de sûreté électriques pour les lieux de travail des employés (ANSI/NFPA 70E-2012) des Etats-Unis et toutes les conditions de sûreté additionnelles de lieu de travail applicables à votre installation.

WARNUNG Der falsche Anschluß dieses Gerätes kann Tod, schwere Verletzungen oder Feuer verursachen. Bevor Sie dieses Instrument anschließen, müssen Sie die Anleitung lesen und verstanden haben. Bei der Verwendung dieses Instruments müssen alle Installation- und Betriebsanweisungen beachtet werden.

Der Anschluß dieses Instruments muß in Übereinstimmung mit den nationalen Bestimmungen für Elektrizität (ANSI/NFPA 70-2014) der Vereinigten Staaten, sowie allen weiteren, in Ihrem Fall anwendbaren Sicherheitsbestimmungen, vorgenommen werden.

Installation, Betrieb und Wartung dieses Instruments dürfen nur von Fachpersonal durchgeführt werden. In dem nationalen Bestimmungen für Elektrizität wird ein Fachmann als eine Person bezeichnet, welche "mit der Bauweise und dem Betrieb des Gerätes sowie den dazugehörigen Gefahren vertraut ist."

Continued on next page

Qualifiziertes Personal, das an bearbeiten oder herausgestellte angezogene elektrische Leiter sich nähern, muß anwendbare Sicherheit bezogener Arbeit Praxis und Verfahren einschließlich passende persönliche schützende Ausrüstung gemäß dem Standard für elektrische Sicherheitsauflagen für Angestellt-Arbeitsplätze (ANSI/NFPA 70E-2012) der Vereinigten Staaten und alle zusätzlichen Arbeitsplatzsicherheitsauflagen folgen, die auf Ihre Installation anwendbar sind.

WARNING To avoid the risk of electric shock or burns, always connect the safety (or earth) ground before making any other connections.

WARNING To reduce the risk of fire, electrical shock, or physical injury it is strongly recommended to fuse the voltage measurement inputs. Fuses must be located as close to circuit connection as possible to maximize protection.

WARNING For continued protection against risk of fire or shock hazard replace only with same type and rating of fuse.

WARNING Do not replace fuse again if failure is repeated. Repeated failure indicates a defective condition that will not clear with replacement of the fuse. Refer condition to a qualified technician.

Safety precautions

The following safety precautions must be followed whenever any type of voltage or current connection is being made to the HDPQ Xplorer.

- Wear proper Personal Protective Equipment, including safety glasses and insulated gloves when making connections to power circuits.
 - Hands, shoes and floor must be dry when making any connection to a power line.
 - Before each use, inspect all cables for breaks or cracks in the insulation. Replace immediately if defective.
 - Set the HDPQ Xplorer power switch to Off.
 - Before connecting to electric circuits to be monitored, open their related circuit breakers or disconnects. DO NOT install any connection of the HDPQ Xplorer to live power lines.
 - Connections must be made to the HDPQ Xplorer first, then connect to the circuit to be monitored.
 - If the equipment is used in a manner not specified in this User Guide, the protection provided by the equipment may be impaired.
-

Continued on next page

Voltage and current connections

This section contains diagrams of both voltage and current probe connections that are required when power measurements are to be made.

Voltage: Voltage probes are connected to the individual source or load line and are referenced to the return (common) line voltage probe connection for greatest accuracy.

Current: Current probes are connected to each line and positioned to measure currents with reference to the voltage probe. Incorrectly positioned current probes may produce erroneous power measurement. Current probes are always oriented with the arrow pointing to the load.

Phasor diagrams

Correct phasor diagrams (for resistive loads) are shown for each connection.

In this appendix The following connections are shown in this appendix.

Topic	See Page
Verifying Voltage and Current Connections	E-5
Interconnect Jumpers	E-7
Single Phase	E-8
Split Phase	E-9
3 Phase, Four Wire Wye	E-10
3 Phase (Floating or Grounded) Delta	E-11
3 Phase 2-Watt Delta	E-12
Generic Circuit	E-13
2 1/2 Element Without Voltage Channel B	E-14
2 1/2 Element Without Voltage Channel C	E-15
Connecting to a Potential Transformer (PT)	E-16
Connecting to a Current Transformer (CT)	E-18

Verifying Voltage and Current Connections

Introduction

Correct voltage and current connection of single phase, split phase, or polyphase connections can be verified using phasor diagrams. Phasor diagrams are graphic representations that show the magnitude and angular relationship of voltage and current for each phase of a monitored connection. Each connection diagram on the following pages shows the correct voltage and current phasor diagrams (for resistive loads) for that circuit.

Displaying the screen

To display the Voltage and Current Phasor screen, from the Home screen press Phasor. The following screen depicting Positive Sequence 3 Phase Delta resistive load will appear.

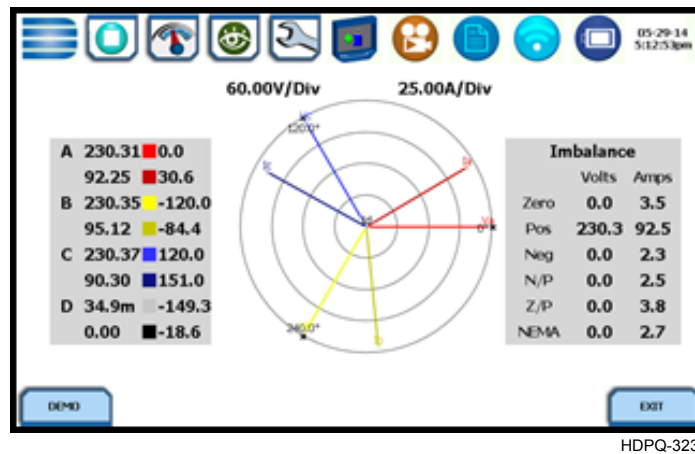

HDPQ-323

The touch screen Demo button presents an animated phasor demo rotation for resistive, capacitive and inductive loads.

Single Phase resistive load

A single phase voltage or current phasor is displayed as a single line showing a channel reference at 0 degrees and a magnitude relative to its measured value. An arrow head on the line indicates direction.

Split phase

Split phase vectors are displayed as dual lines showing channel references and magnitudes and opposite (180 degrees) directions.

Three phase

Three phase vectors are displayed as three lines, 120 degrees apart in a resistive load (unity power factor). Phase displacement will occur in a reactive or capacitive load.

Continued on next page

**Incorrect
current phasor
diagram**

Phasor displays that show incorrect current probe connection can be corrected by reconnecting the probe so that the arrow on the probe handle points toward the load.

HDPQ Xplorer is able to display diagrams of wiring configurations to assist you in the selection of circuit type appropriate for your application (see Chapter 4 Setup Monitoring - Circuit Type Selection). The instrument compares the detected voltages, currents, and phase sequence (if applicable) to the selected circuit type. HDPQ Xplorer issues a message if the specified circuit type and the actual voltage/current connections match.

The next pages describe and illustrate the wiring configurations available for set up in HDPQ Xplorer.

Interconnect Jumpers

Interconnect jumpers

The standard cable set for the HDPQ includes four (4) interconnect jumpers bearing part number 114013-G1. These interconnect jumpers can be used to connect the same conductor points together and are rated 600V CAT III. When using the interconnect jumpers, also use the supplied wire markers to identify the wiring connections applicable to your installation.

Refer to Appendix A Optional Accessories for more information on the list of available wire markers.

WARNINGS

DO NOT EXCEED 600 VRMS when using Dranetz P/N 114013-G1 interconnect jumpers.

For circuit configurations above 600VRMS each voltage channel input is to be individually connected to the HDPQ instrument with the supplied 1000V CAT III cables and safety clips ONLY.

Single Phase

Introduction When making voltage connections to a single phase circuit use channel A differential inputs as shown below. The figure also shows voltage connection using channel D as a differential input for measuring neutral to ground voltage. Neutral to ground measurements are important but optional.

NOTE Be sure to connect the current probe with the arrow on the handle pointing towards the load or an erroneous power reading will result.

Connection diagram

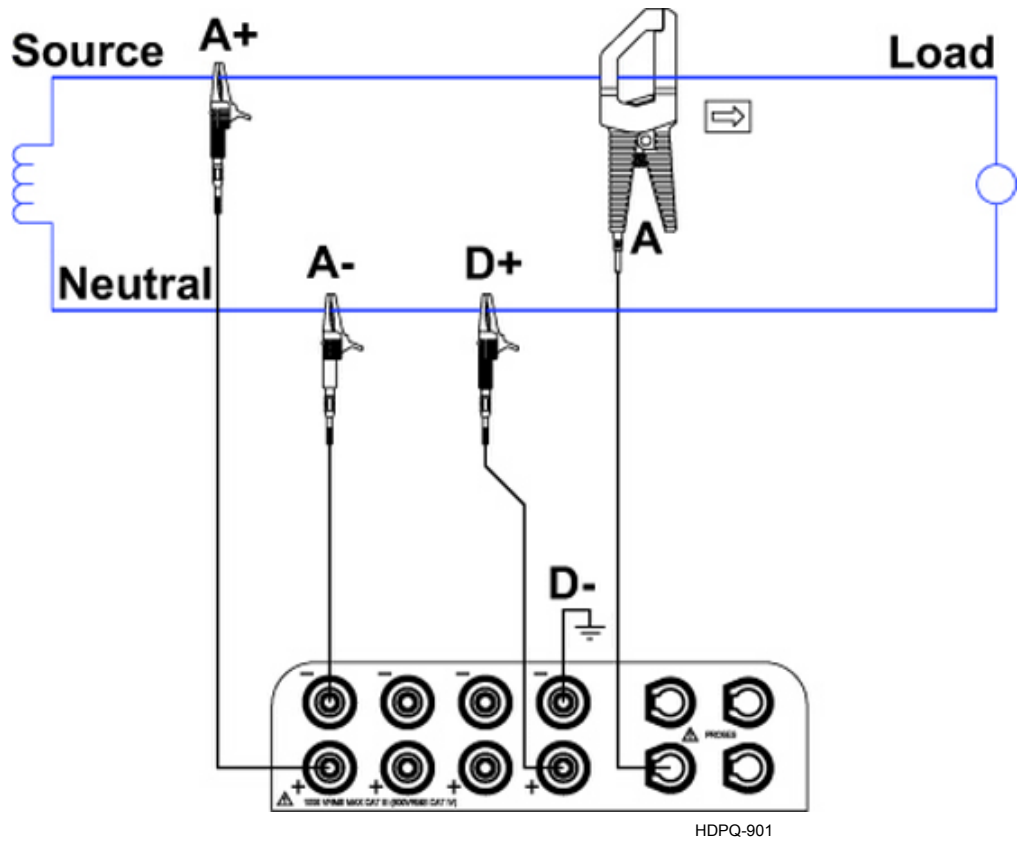

Phasor diagrams

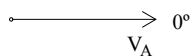

Split Phase

Introduction

When making split phase measurements, use both channels A and B for voltage and current connections. The neutral is chosen as the reference for measurement purposes. The figure also shows voltage connection using channel D as a differential input for measuring neutral to ground voltage. Neutral to ground measurements are important but optional.

Connection diagram

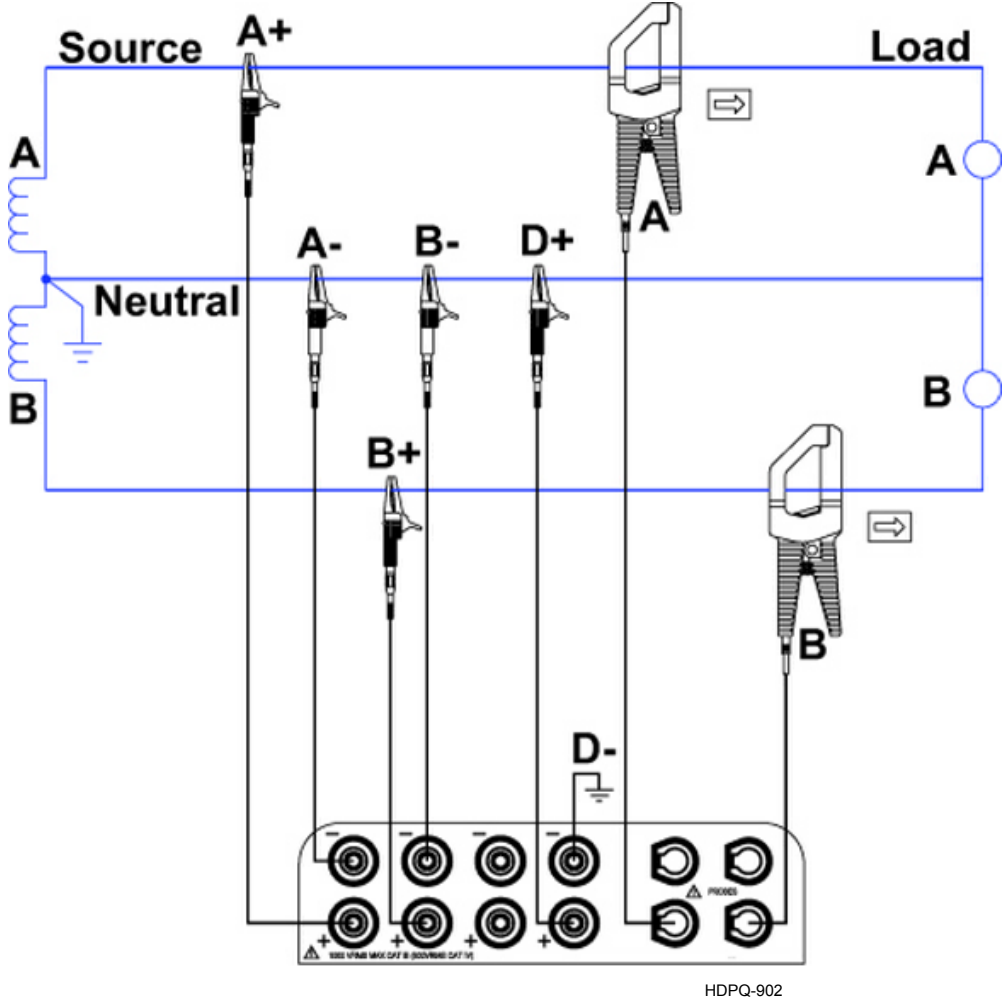

Phasor diagrams



3 Phase, Four Wire Wye

Introduction

Channels A, B, and C are connected to voltage and current probes. The neutral is connected to common and is the reference for the three channels. The figure also shows voltage connection using channel D as a differential input for measuring neutral to ground voltage. Neutral to ground measurements are important but optional.

Connection diagram

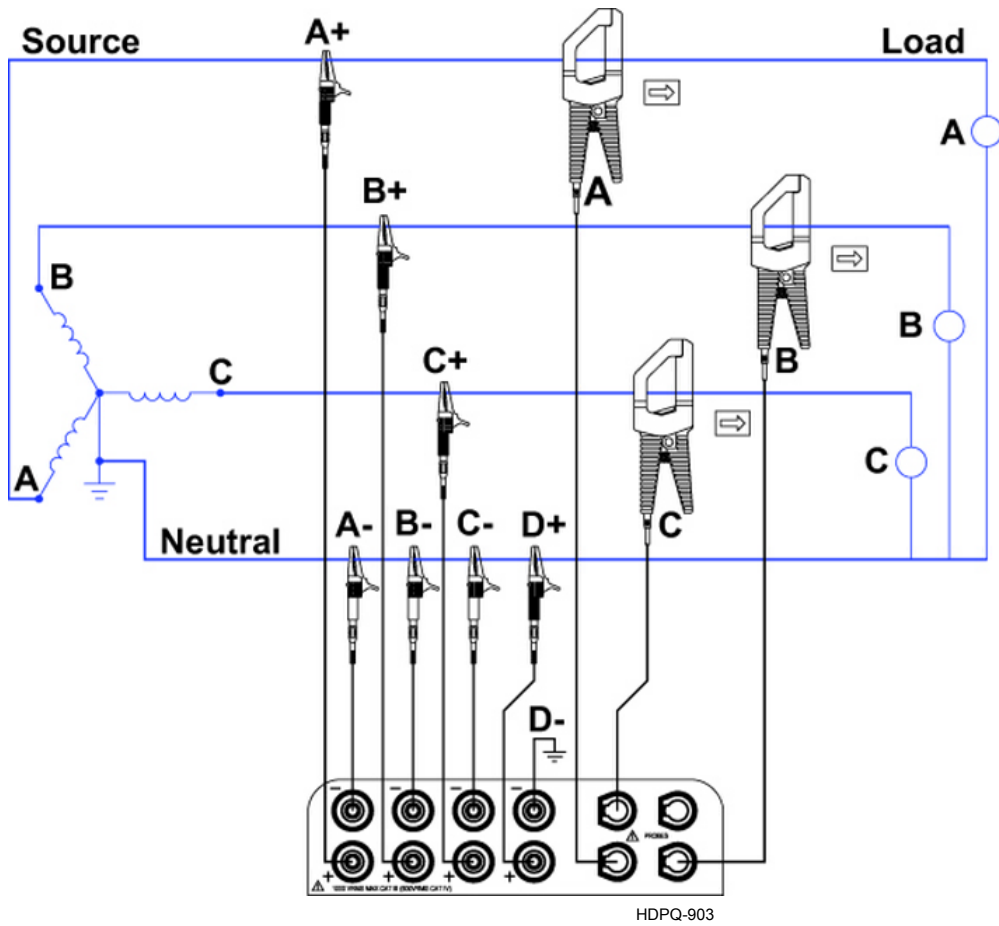

Phasor diagrams

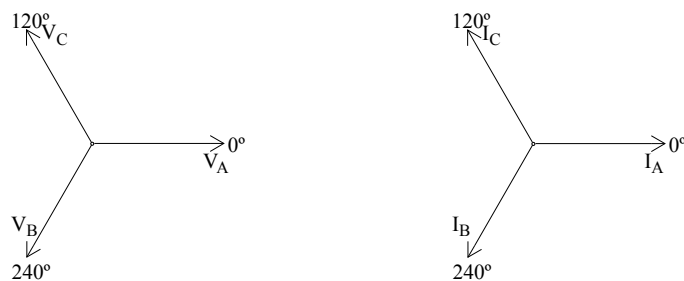

3 Phase (Floating or Grounded) Delta

Introduction

In this power connection, the HDPQ Xplorer uses voltage channels A, B, and C as differential inputs with channel A using source voltage A-B, channel B using B-C, and channel C using C-A as the reference. Current probes are connected to channels A, B, and C. Neutral to ground measurements are important but optional.

Connection diagram

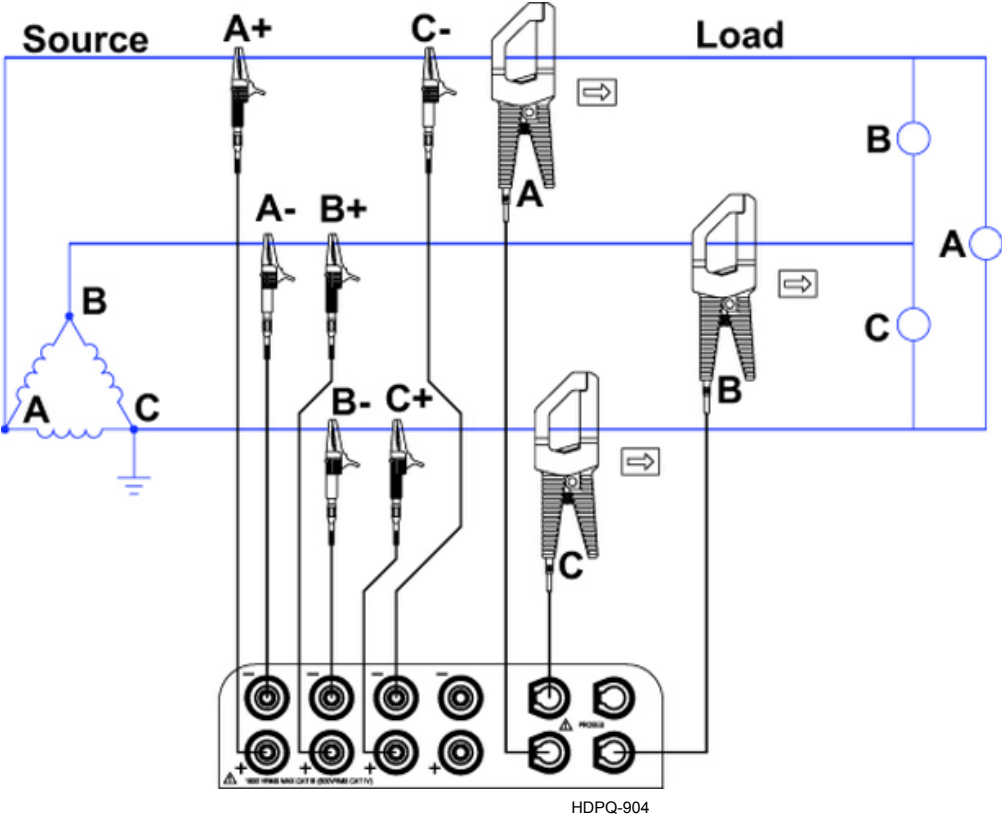

Floating Delta phasor diagrams

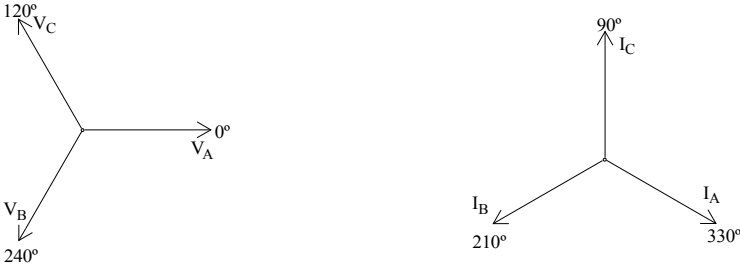

3 Phase 2-Watt Delta

Introduction

The figure below shows the 3 Phase 2-Watt delta connection using phase channels A-B-C. Current probes are connected to channels A and B. Neutral to ground measurements are important but optional.

Connection diagram

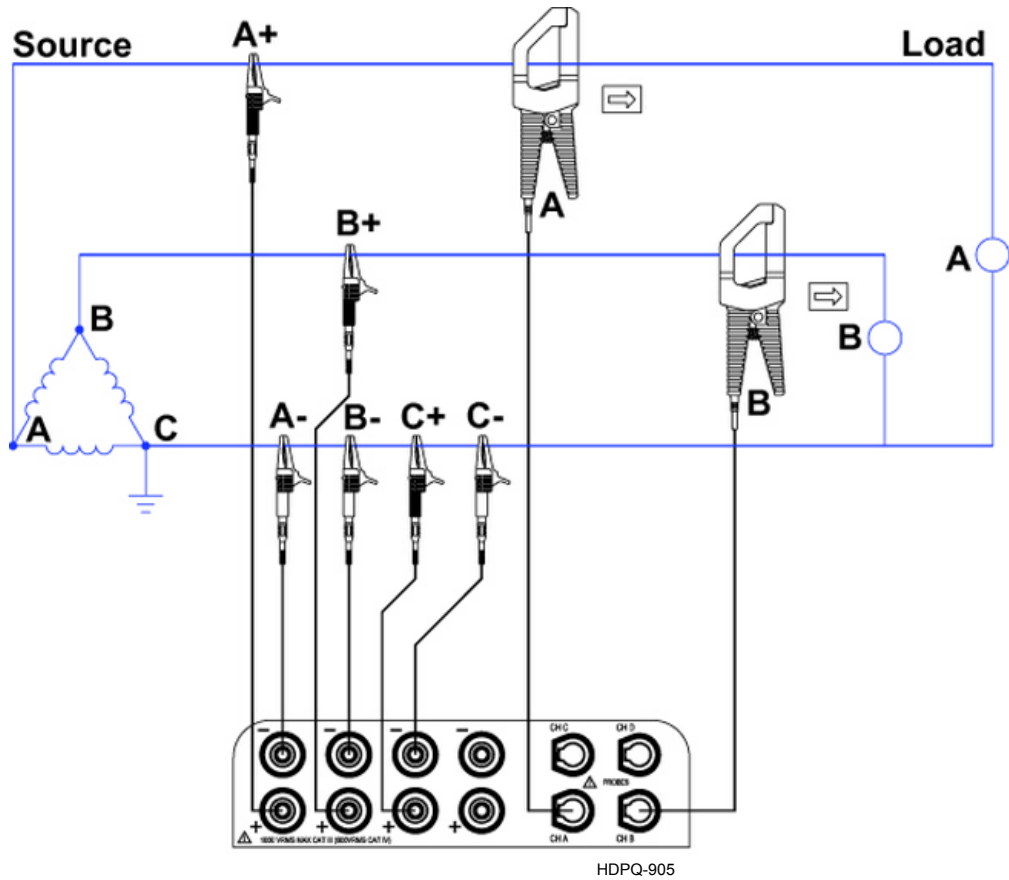

Phasor diagrams

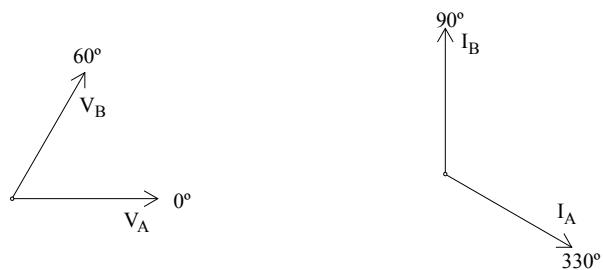

Generic Circuit

Introduction

In the Generic circuit connection, the HDPQ Xplorer uses voltage channels A, B, C, and D as differential inputs. Current probes are connected to channels A, B, C, and D.

Connection diagram

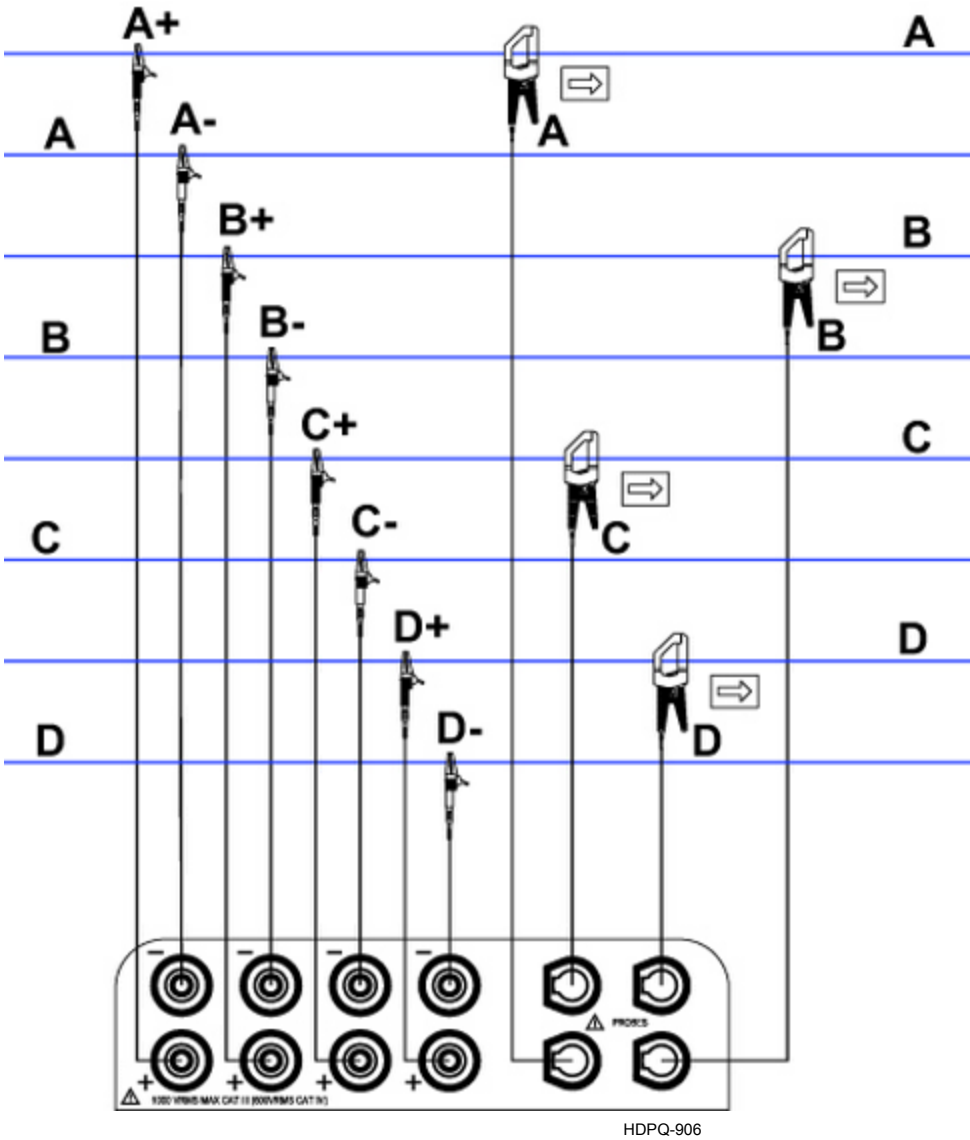

2 1/2 Element Without Voltage Channel B

Introduction

Channels A and C are connected to voltage. Current probes are connected to channels A, B and C. The neutral is connected to common and is the reference for the three channels. The figure also shows voltage connection using channel D as a differential input for measuring neutral to ground voltage. Neutral to ground measurements are important but optional.

Connection diagram

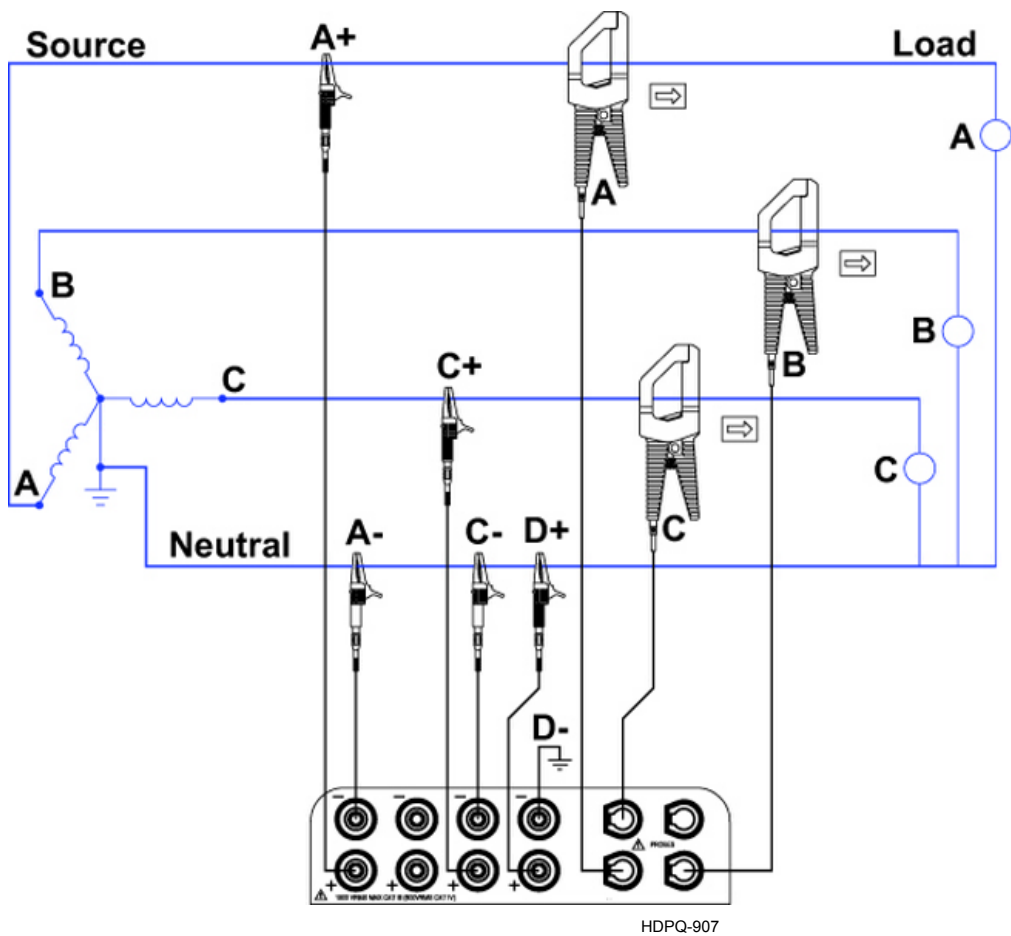

Phasor diagrams

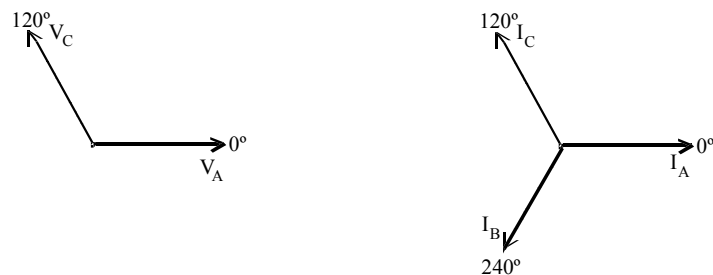

2 1/2 Element Without Voltage Channel C

Introduction

Channels A and B are connected to voltage. Current probes are connected to channels A, B and C. The neutral is connected to common and is the reference for the three channels. The figure also shows voltage connection using channel D as a differential input for measuring neutral to ground voltage. Neutral to ground measurements are important but optional.

Connection diagram

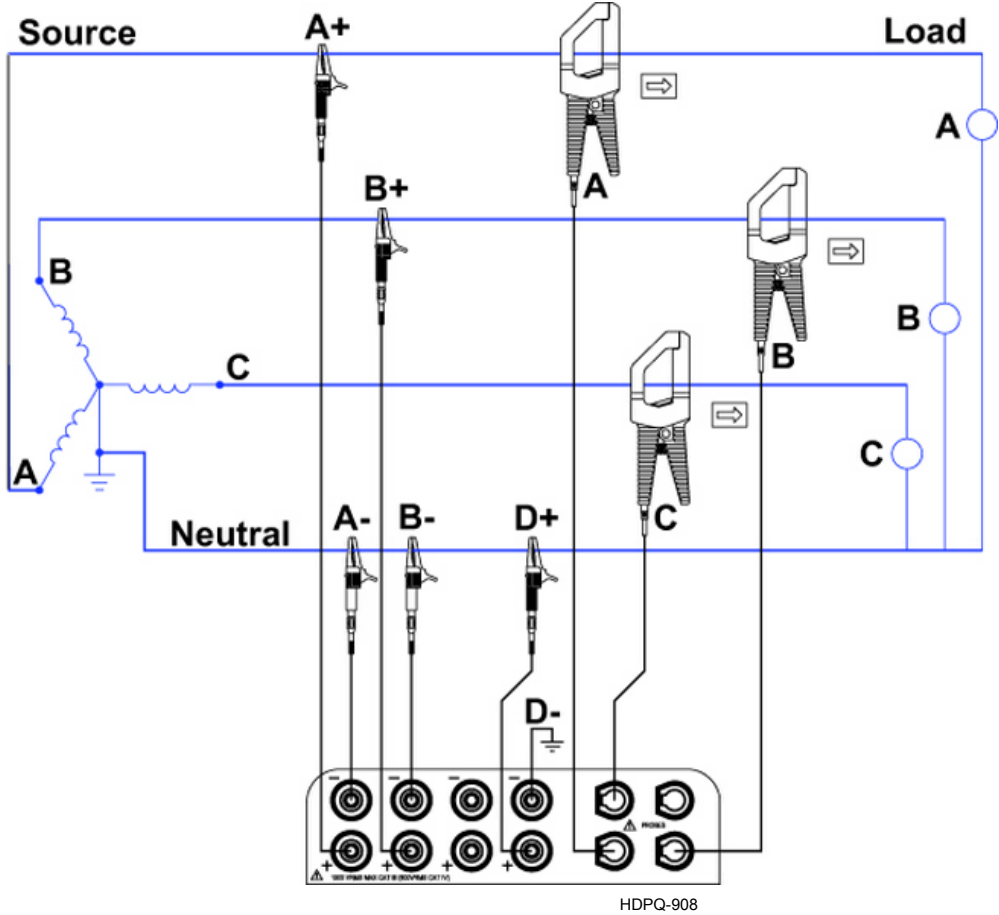

Phasor diagrams

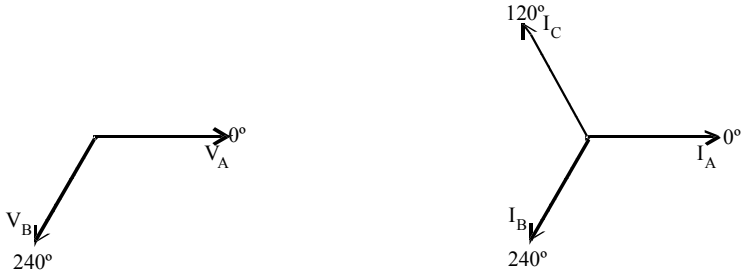

Connecting to a Potential Transformer

**Safety
Precautions**

Follow the safety precautions listed on page E-3 when making all potential transformer connections.

NOTE

Potential Transformers are not manufactured by Dranetz and are discussed here for informational purposes only.

Definition

A potential transformer (PT), also referred to as a voltage instrument transformer, provides the necessary step-down ratio to reduce the high voltage of circuits above 1000 Vrms to a level for safe measurement. A PT also provides isolation and proper connections for instrument attachment.

Connections

PTs are usually fixed in position and require that the voltage probe(s) be connected to their terminal connections.

WARNING

Refer to the manufacturer's instructions, related to the PT, for exact information for probe connection for voltage monitoring. Do not exceed 1000 Vrms input to the HDPQ Xplorer voltage inputs.

ADVERTENCIA

Consulte las instrucciones del fabricante referentes a TP (transformador potencial), para la información exacta de la conexión de sonda a fin de monitorear el voltaje. No supere la entrada de 1000 Vrms a las entradas de voltaje de HDPQ Xplorer.

AVERTISSEMENT

Se reporter aux instructions du fabricant relatives au transformateur de tension (Potential Transformer - PT) pour obtenir les renseignements exacts sur la connexion de sonde utilisée pour la surveillance du courant. Ne pas dépasser l'entrée de tension efficace de 1000 RMS dans les entrées de tension de HDPQ Xplorer volts.

WARNUNG

Genauere Informationen zur Meßfühlerverbindung für die Spannungsüberwachung entnehmen Sie bitte den Anleitungen des Herstellers (siehe Spannungsteilertransformator). Die Eingangsspannung von 1000 V (Effektivwert) in die HDPQ Xplorer Spannungseingänge sollte nicht überschritten werden.

Procedure Follow these steps to connect voltage probes to a potential transformer.

Step	Action
1	Turn off power to the PT.
2	Connect the colored voltage probes to the channel inputs on the HDPQ Xplorer top panel.
3	Connect the colored voltage probes to the PT's connections in accordance with the manufacturer's instructions.
4	Turn on power to the PT.

Scale factor The scale factor of the PT must be accounted for in making accurate voltage measurements. Because the monitored output voltage of the PT is stepped-down (divided) from the original voltage, this ratio must be stepped-up (multiplied) by the HDPQ Xplorer when voltage computations are performed. The PT scale factor is usually mounted on the PT assembly and is entered into the HDPQ Xplorer on the scale factors screen. Refer to the PT manufacturer's literature for the scale factor of the device you are using.

Connecting to a Current Transformer (CT)

Safety precautions

The following safety precautions apply to current transformer (CT) connections in addition to those safety precautions stated on page E-3.

- Never energize a CT with the secondary open.
 - Never disconnect the secondary of a CT with primary energized.
-

WARNING

Refer to the manufacturer's instructions related to the CT for exact information for connections for current monitoring. Do not exceed manufacturer's ratings.

ADVERTENCIA

Consulte las instrucciones del fabricante referentes a TC (transformador de corriente) para la información exacta de las conexiones a fin de monitorear la corriente. No exceda las capacidades nominales del fabricante.

AVERTISSEMENT

Se reporter aux instructions du fabricant relatives au transformateur de courant (Current Transformer - CT) pour obtenir les renseignements exacts sur les connexions utilisées pour la surveillance du courant. Ne pas dépasser la puissance recommandée par le fabricant.

WARNUNG

Genau Informationen zu Verbindungen für die Stromüberwachung entnehmen Sie bitte den Anleitungen des Herstellers (siehe Stromumwandler). Die Grenzwerte des Herstellers sollten nicht überschritten werden.

NOTE

Current Transformers are not manufactured by Dranetz and are discussed here for informational purposes only.

Description

Current transformers, also known as instrument transformers, reduce high level currents to low level currents so they can be safely monitored. These devices are similar to PTs used for voltage measurements in that both reduce values for safe measurement. The reduction, or step-down ratio, is stated as a scale factor that is used by the HDPQ Xplorer to step-up the measured value to its original value.

Types of CTs

There are single-phase CTs and polyphase CTs dependent on the source transformer used. Current reduction ratios vary widely and are also dependent on the source transformer used. Rating plates attached to the CT provide information as to the ratio and current limitations.

APPENDIX F



PQ Parameter Calculations

Calculations

Measuring and monitoring power quality (PQ) parameters require several calculations, i.e. RMS values of voltage and current, etc. Depending on the type of parameter measured, calculations are performed using samples of monitored waveforms or using every sample cycle for quick disturbance detection. This section defines the parameters used in PQ calculations.

NOTE: The parameter specifications provided in this section are for reference only and are subject to change without notice.

Description	Abbreviation	Wiring Configuration	Formula	Units	Precision
Volts RMS Derived from 200mS (10/12 cycles 50/60 Hz) Aggregated to selected interval	Vrms-a Vrms-b Vrms-c Vrms-d	Single phase Split phase Wye	$V_{rms} = \sqrt{\frac{\sum_{i=1}^n U^2}{n}}$ where n=512 samples	Volts	+/- 0.1% of Reading * 15 KHz BW
	Vrms-ab Vrms-bc Vrms-ca	Measured for Delta Calculated for Wye			
Volts DC Derived from 200mS (10/12 cycles 50/60 Hz) Aggregated to selected interval	Vdc-a Vdc-b Vdc-c Vdc-d	Single phase Split phase Wye	$V_{dc} = \frac{\sum_{i=1}^n U}{n}$ where n=512 samples	Volts	+/- 0.2% of Reading *
	Vdc-ab Vdc-bc Vdc-ca	Measured for Delta Calculated for Wye			
Volts ½ cycle slide Cyclic RMS of full cycle restarted every ½ cycle (used in Sag/Swell detection)	Vcyc-a Vcyc-b Vcyc-c Vcyc-d	Single phase Split phase Wye	$V_{rms} = \sqrt{\frac{\sum_{i=1}^n U^2}{n}}$ where n=512 samples	Volts	+/- 0.2% of Reading *
	Vcyc-ab Vcyc-bc Vcyc-ca	Measured for Delta Calculated for Wye			
DC of individual Cycle	Vcycdc-a Vcycdc-b Vcycdc-c Vcycdc-d	Single phase Split phase Wye	$V_{dc} = \frac{\sum_{i=1}^n U}{n}$ where n=512 samples	Volts	+/- 0.2% of Reading *
	Vcycdc-ab Vcycdc-bc Vcycdc-ca	Measured for Delta Calculated for Wye			

* +/- 0.05% of FS for input < 40V

**Calculations
(continued)**

Description	Abbreviation	Wiring Configuration	Formula	Units	Precision
RMS Deviation Subtraction of 1 cycle RMS from adjacent cycles. Used for cyclic waveshape transient trigger system.	Vcycw-a Vcycw-b Vcycw-c Vcycw-d	Single phase Split phase Wye	Vrms(cycle 1) - Vrms(cycle 2)	Volts	+/- 0.2% of Reading * 15 KHz BW
	Vcycw-ab Vcycw-bc Vcycw-ca	Measured for Delta Not Calculated for Wye			
Maximum magnitude value of Crest. Largest Absolute magnitude of samples in a 1/2 cycle. Used for cyclic waveshape transient trigger system.	Vpk-a Vpk-b Vpk-c Vpk-d	Single phase Split phase Wye	Largest Absolute magnitude of 256 samples (1/2 cycle)	Volts	+/- 0.2% of Reading *
	Vpk-ab Vpk-bc Vpk-ca	Measured for Delta Not Calculated for Wye			
Phase of fundamental on individual cycle. Derived from DFT output based on sync channel.	Vcycdeg-a Vcycdeg-b Vcycdeg-c Vcycdeg-d	Single phase Split phase Wye	$f(t) = \sin \omega_n \tau + \delta_n$ where g= phase where n=1 for 1 st harmonic	Degree	+/- 1°
	Vcycdeg-ab Vcycdeg-bc Vcycdeg-ca	Measured for Delta Calculated for Wye			
Phase of fundamental averaged over 200ms. Derived from DFT sine expansion output.	Vdeg-a Vdeg-b Vdeg-c Vdeg-d	Single phase Split phase Wye	$f(t) = \sin \omega_n \tau + \delta_n$ where n=1 for 1 st harmonic Averaged over 10/12 cycles	Degree	+/- 1°
	Vdeg-ab Vdeg-bc Vdeg-ca	Measured for Delta Calculated for Wye			
* +/- 0.05% of FS for input < 40V					

**Calculations
(continued)**

Description	Abbreviation	Wiring Configuration	Formula	Units	Precision
Volts RMS of fundamental Derived from DFT	Vfnd-a Vfnd-b Vfnd-c Vfnd-d	Single phase Split phase Wye	$V_{fund} = \frac{V_{pk}}{\sqrt{2}}$	Volts	+/- 0.2% of Reading * 15 KHz BW
	Vfnd-ab Vfnd-bc Vfnd-ca	Measured for Delta Calculated for Wye	V_{pk} is calculated from the 1 st harmonic of DFT		
NEMA Unbalance Max deviation of the 3 phases from the average of the 3.	Vunbal-a Vunbal-b Vunbal-c	Measured for Wye	$V_{unbal} = \frac{ V_x - V_{avg} }{V_{avg}}$	%	+/- 1 %
	Vunbal-max		V_x is channel with largest deviation from average		
	Vunbal-ab Vunbal-bc Vunbal-ca	Measured for Delta Not Calculated for Wye	V_{avg} is average of the three channels		
Symmetrical Components					
Zero Sequence	Vseqzro	Delta or Wye only	$U_{0a} = \frac{1}{3} [U_a + U_b + U_c]$	None	+/- 0.15 %
Positive Sequence	Vseqpos		$U_{1a} = \frac{1}{3} [U_a + a^1 U_b + 2a^2 U_c]$		
Negative Sequence	Vseqneg		$U_{2a} = \frac{1}{3} [U_a + 2a^2 U_b + a^1 U_c]$		
Negative Unbalance	Vunbalneg		$\frac{s_2}{s_1} \frac{U_{2a}}{U_{1a}}$		
Zero Unbalance	Vunbalzro		$\frac{s_0}{s_1} \frac{U_{0a}}{U_{1a}}$		
Frequency Freq of sync channel	Vfreq	Any	$\left[\frac{\text{Sum of 10s of cycles periods}}{10} \right]^{-1}$	Hz	+/- 10 mHz
Rapid Voltage Change	Vrvc-a	Any	Max Deviation from 1 sec steady state RMS as defined in NVE-1157	%	+/- 0.2 %
	Vrvc-b				
	Vrvc-c				
	Vrvc-d				
* +/- 0.05% of FS for input < 40V					

**Calculations
(continued)**

Description	Abbreviation	Wiring Configuration	Formula	Units	Precision
Amps RMS Derived from 200mS (10/12 cycles 50/60 Hz) Aggregated to selected interval	Irms-a Irms-b Irms-c Irms-d	Any	$I_{rms} = \sqrt{\frac{\sum_{i=1}^n I^2}{n}}$ where n=512 samples	Amps	+/- 0.1% of Reading +/- 0.05% of FS 9 KHz BW
Amp ½ cycle slide Cyclic RMS of full cycle restarted every ½ cycle	Icyc-a Icyc-b Icyc-c Icyc-d	Any	$I_{rms} = \sqrt{\frac{\sum_{i=1}^n I^2}{n}}$ where n=512 samples	Amps	+/- 0.1% of Reading +/- 0.1% of FS 9 KHz BW
Amps DC Derived from 200mS (10/12 cycles 50/60 Hz) Aggregated to selected interval.	Idc-a Idc-b Idc-c Idc-d	Any	$I_{dc} = \frac{\sum_{i=1}^n I}{n}$ where n=512 samples	Amps	+/- 0.2% of Reading +/- 0.1% of FS
RMS Deviation Subtraction of 1 cycle RMS from adjacent cycles. Used for cyclic waveshape transient trigger system.	Icycw-a Icycw-b Icycw-c Icycw-d	Single phase Split phase Wye	Irms(cycle 1) - Irms(cycle 2)	Amps	+/- 0.2% of Reading +/- 0.1% of FS 9 KHz BW
Maximum magnitude value of Crest. Largest Absolute magnitude of samples in a ½ cycle. Used for cyclic waveshape transient trigger system.	Ipk-a Ipk-b Ipk-c Ipk-d	Single phase Split phase Wye	Largest Absolute magnitude of 256 samples (1/2 cycle)	Amps	+/- 0.2% of Reading +/- 0.1% of FS
DC of individual Cycle	Icycdc-a Icycdc-b Icycdc-c Icycdc-d	Any	$I_{dc} = \frac{\sum_{i=1}^n I}{n}$ where n=512 samples	Amps	+/- 0.2% of Reading

**Calculations
(continued)**

Description	Abbreviation	Wiring Configuration	Formula	Units	Precision
Phase of fundamental averaged over 200ms. Derived from DFT sine expansion output.	Ideg-a Ideg-b Ideg-c Ideg-d	Any	$f(t) = \sin \omega_n \tau + \delta_n$ where n=1 for 1 st harmonic. Averaged over 10/12 cycles	Degree	+/- 1°
Phase of fundamental on individual cycle. Derived from DFT output based on sync channel.	Icycdeg-a Icycdeg-b Icycdeg-c Icycdeg-d	Any	$f(t) = \sin \omega_n \tau + \delta_n$ where g= phase where n=1 for 1 st harmonic	Degree	+/- 1°
Amps RMS of fundamental Derived from DFT	Ifnd-a Ifnd-b Ifnd-c Ifnd-d	Any	$I_{fund} = \frac{I_{pk}}{\sqrt{2}}$ I _{pk} is calculated from the 1 st harmonic of DFT	Volts	+/- 0.2% of Reading 9 KHz BW
NEMA Current Unbalance Max deviation of the 3 phases from the average of the 3.	Iunbal-a Iunbal-b Iunbal-c	Any	$I_{unbal} = \frac{ I_x - I_{avg} }{I_{avg}}$	%	+/- 1 %
Symmetrical Components					
Zero Sequence	Iseqzro	Delta or Wye only	$U0_a = \frac{1}{3} [U_a + U_b + U_c]$	None	+/- 1 %
Positive Sequence	Iseqpos		$U1_a = \frac{1}{3} [U_a + a^2 U_b + 2a U_c]$		
Negative Sequence	Iseqneg		$U2_a = \frac{1}{3} [U_a + 2a^2 U_b + a U_c]$		
Negative Unbalance	Iunbalneg		$\frac{s_2}{s_1} \frac{U2_a}{U1_a}$		
Zero Unbalance	Iunbalzro		$\frac{s_0}{s_1} \frac{U0_a}{U1_a}$		

**Calculations
(continued)**

Description	Abbreviation	Wiring Configuration	Formula	Units	Precision
Residual Current	Ires	Delta or Wye only	RMS of $\sum_{i=1}^n(Ia + Ib + Ic)$ where n=512 samples	Amps	0.3 % of Reading +/- 0.15% of FS
Net Current	Inet	Wye only	RMS of $\sum_{i=1}^n(Ia + Ib + Ic + Id)$ where n=512 samples	Amps	0.4 % of Reading +/- 0.15% of FS
Watts, Real Power	W-a	Wye, uses measured values Delta uses calculated phantom Neutral Values	$W = \frac{\sum_{i=1}^n(V \cdot I)}{512}$ where n=512 samples $W = W_a + W_b + W_c$	Watts	0.2 % of Reading +/- 0.05% of FS
	W-b				
	W-c				
	W-d				
	W-total				
Volt-Amps	VA-a	Wye, uses measured values Delta uses calculated phantom Neutral Values	$VA = V_{RMS} \times I_{RMS}$ $A = VA_a + VA_b + VA_c$	VA	0.2 % of Reading +/- 0.05% of FS
	VA-b				
	VA-c				
	VA-d				
	VA-total				
Volt-Amps Reactive	VAR-a	Wye, uses measured values Delta uses calculated phantom Neutral Values	$VAR = V_{RMS-Fund} \times I_{RMS-R-Fund} \times \sin(\phi)$ Calculated using Fundamentals of V and I obtained from DFT $VAR\text{-Total} = VAR_a + VAR_b + VAR_c$	VAR	0.2 % of Reading +/- 0.05% of FS
	VAR-b				
	VAR-c				
	VAR-d				
	VAR-total				
Watts, Fundamental	Wf-a	Wye, uses measured values Delta uses calculated phantom Neutral Values	$W_{fund} = \frac{\sum_{i=1}^n V_{fund} \cdot I_{fund}}{512}$ where n=512 samples Waveform data derived from DFT $W_{fund\text{Total}} = W_{fund\text{a}} + W_{fund\text{b}} + W_{fund\text{c}}$	Watts	0.2 % of Reading +/- 0.05% of FS
	Wf-b				
	Wf-c				
	Wf-d				
	Wf-total				
VA Vector Total	VA-tot	Wye and Neutral based measurements	$VA_{vect-tot} = \sqrt{W_{fund\text{-Tot}}^2 + VAR_{fund\text{-tot}}^2}$	VA	0.2 % of Reading +/- 0.05% of FS

**Calculations
(continued)**

Description	Abbreviation	Wiring Configuration	Formula	Units	Precision
VA Arithmetic Fundamental Total	VAfa-tot	Wye and Neutral based measurements	$=VAa_{fund} + VAb_{fund} + VAc_{fund}$	VA	0.2 % of Reading +/- 0.05% of FS
True Power Factor	TPF-a	Wye, uses measured values Not meaningful for Delta	$PF = \frac{Watts}{VA}$	None	1% of Reading
	TPF-b				
	TPF-c				
	TPF-d				
Displacement Power Factor	DPF-a	Wye, uses measured values Not meaningful for Delta	$DPF = \cos(\theta_{volts} - \theta_{amps})$ DFT derived fundamental of Volts and Amps	None	1% of Reading
	DPF-b				
	DPF-c				
	DPF-d				
Phase of Volts to Amps of fundamental on individual cycle Derived from DFT	VIddeg-a	Not meaningful for Delta	$VIddeg = \delta_{vfa} - \delta_{ifa}$ $VIddeg = \delta_{vfb} - \delta_{ifb}$ $IIddeg = \delta_{vfc} - \delta_{ifc}$ $VIddeg = \delta_{vfd} - \delta_{ifd}$ $f(t) = \sin \omega_n \tau + \delta_n$ where g= phase where n=1 for 1 st harmonic	Degree	+/- 1°
	VIddeg-b				
	VIddeg-c				
	VIddeg-d				
TPF worst case of A,B,C	TPFworst	Not meaningful for Delta	Max of 1- TPF _a , 1- TPF _b , 1- TPF _c	None	+/- 1%
Total Vector Power Factor	TPFv-tot	All	$= \frac{W_{tot}}{VA_{tot-vec}}$	None	+/- 1%
Total Arithmetic Power Factor	TPFa-tot	All	$= \frac{W_{tot}}{VA_{tot-arithmetic}}$	None	+/- 1%
DPF average	DPFavg	All	$= \frac{DPFa + DPFb + DPFc}{3}$	None	+/- 1%
DPF worst case of A,B,C	DPFworst	All	DPF of channel with largest deviation from 1.0	None	+/- 1%

**Calculations
(continued)**

Description	Abbreviation	Wiring Configuration	Formula	Units	Precision
Total Arithmetic Displacement Power Factor	DPFa-tot	All	$= \frac{W_{tot}}{VA_{tot-arithmic}}$ VA derived from DFT fundamental	None	+/- 1%
Total Vector Displacement Power Factor	DPFv-tot	All	$= \frac{W_{tot}}{VA_{tot-vect}}$ VA derived from DFT fundamental	None	+/- 1%
Total Voltage Harmonic Distortion Normalized to the fundamental	HVthdfund-a	All	$= \frac{\sqrt{HV_2^2 + HV_3^2 - HV_{127}^2}}{HV_{fund}} * 100$ Per 61000-4-7	%	+/- 5%
	HVthdfund-b				
	HVthdfund-c				
	HVthdfund-d				
	HVthdfund-ab				
	HVthdfund-bc				
	HVthdfund-ca				
Total Current Harmonic Distortion Normalized to the fundamental	HIthdfund-a	All	$= \frac{\sqrt{HI_2^2 + HI_3^2 - HI_{63}^2}}{HI_{fund}} * 100$ Per 61000-4-7	%	+/- 5%
	HIthdfund-b				
	HIthdfund-c				
	HIthdfund-d				
Total Voltage InterHarmonic Distortion Normalized to the fundamental	HVtidfund-a	All	$= \frac{\sqrt{HigV_2^2 + HigV_3^2 - HigV_{127}^2}}{HV_{fund}} * 100$ HigV is Voltage Interharmonic Group Per 61000-4-7	%	+/- 5%
	HVidfund-b				
	HVtidfund-c				
	HVtidfund-d				
	HVtidfund-ab				
	HVtidfund-bc				
	HVtidfund-ca				
Total Current InterHarmonic Distortion Normalized to the fundamental	HItidfund-a	All	$= \frac{\sqrt{HigI_2^2 + HigI_3^2 - HigI_{63}^2}}{HV_{fund}} * 100$ HigI is Current Interharmonic Group Per 61000-4-7	%	+/- 5%
	HItidfund-b				
	HItidfund-c				
	HItidfund-d				

**Calculations
(continued)**

Description	Abbreviation	Wiring Configuration	Formula	Units	Precision
Total Voltage Harmonic Distortion Root Sum of Squares (RSS)	HVthdrss-a	All	$= \sqrt{HV_2^2 + HV_3^2 \dots HV_{127}^2}$ Per 61000-4-7	%	+/- 5%
	HVthdrss-b				
	HVthdrss-c				
	HVthdrss-d				
	HVthdrss-ab				
	HVthdrss-bc				
	HVthdrss-ca				
Total Voltage Inter Harmonic Distortion Root Sum of Squares (RSS)	HVtidrss-a	All	$= \sqrt{HigV_2^2 + HigV_3^2 \dots HigV_{127}^2}$ HigI is Voltage Inter-harmonic Group Per 61000-4-7	%	+/- 5%
	HVtidrss-b				
	HVtidrss-c				
	HVtidrss-d				
	HVtidrss-ab				
	HVtidrss-bc				
	HVtidrss-ca				
Total Odd Voltage Harmonic Distortion Normalized to the fundamental	HVo hd-a	All	$= \frac{\sqrt{HV_3^2 + HV_5^2 \dots HV_{127}^2}}{HV_{fund}} * 100$ Per 61000-4-7	%	+/- 5%
	HVo hd-b				
	HVo hd-c				
	HVo hd-d				
	HVo hd-ab				
	HVo hd-bc				
	HVo hd-ca				
Total Even Voltage Harmonic Distortion Normalized to the fundamental	HVe hd-a	All	$= \frac{\sqrt{HV_2^2 + HV_4^2 \dots HV_{126}^2}}{HV_{fund}} * 100$ Per 61000-4-7	%	+/- 5%
	HVe hd-b				
	HVe hd-c				
	HVe hd-d				
	HVe hd-ab				
	HVe hd-bc				
	HVe hd-ca				
Total Current Odd Harmonic Distortion Normalized to the fundamental	HIo hd-a	All	$= \frac{\sqrt{HI_3^2 + HI_5^2 \dots HI_{63}^2}}{HV_{fund}} * 100$ Per 61000-4-7	%	+/- 5%
	HIo hd-b				
	HIo hd-c				
	HIo hd-d				

**Calculations
(continued)**

Description	Abbreviation	Wiring Configuration	Formula	Units	Precision
Total Current Even Harmonic Distortion Normalized to the fundamental	Hlehd-a	All	$= \frac{\sqrt{HI_2^2 + HI_4^2 - HI_{E2}^2}}{HV_{fund}} * 100$	%	+/- 5%
	Hlehd-b				
	Hlehd-c				
	Hlehd-d				
			Per 61000-4-7		
Telephone Influence Factor, normalized to Fundamental	HVtiffund-a	All	$TIF = \frac{\sqrt{\sum(x_f \cdot W_f)^2}}{X_{fund}}$	None	+/- 1%
	HVtiffund-b				
	HVtiffund-c				
	HVtiffund-d				
			where:		
			X _{fund} = Total RMS of fund		
			X _f = single frequency RMS at frequency f		
			W _f = Single frequency weighing factor at frequency f		
			Per IEEE 519/D7 1990 covers weighing factors up to 5 KHz		
Telephone Influence Factor, normalized to RMS of input	HVtifrms-a	All	$TIF = \frac{\sqrt{\sum(x_f \cdot W_f)^2}}{X}$	None	+/- 1%
	HVtifrms-b				
	HVtifrms-c				
	HVtifrms-d				
			where:		
			X = RMS of channel		
			X _f = single frequency RMS at frequency f		
			W _f = single frequency weighing factor at frequency f		
			Per IEEE 519/D7 1990 covers weighing factors up to 5 KHz		

**Calculations
(continued)**

Description	Abbreviation	Wiring Configuration	Formula	Units	Precision
Total Harmonic unsigned power	Huspower-a	All	$= \sum_{n=2}^{63} V_n I_n \cos \phi_n $	Watts	+/- 5%
	Huspower-b				
	Huspower-c				
	Huspower-d				
Total Harmonic signed power	Hspower-a	All	$= \sum_{n=2}^{63} V_n I_n \cos \phi_n $	Watts	+/- 5%
	Hspower-b				
	Hspower-c				
	Hspower-d				
Transformer K Factor	Hlxfmrk-a	All	$K = \frac{\sum_{n=2}^{63} (HI_n^2 + n^2)}{\sum_{n=2}^{63} HI_n^2}$	None	+/- 5%
	Hlxfmrk-b				
	Hlxfmrk-c				
	Hlxfmrk-d				
Transformer De-Rating Factor	Hlxfmrdrat-a	All	$= \sqrt{\frac{P_{LL,R}}{(1+P_{HL}+P_{EC,R})}}$	None	+/- 5%
	Hlxfmrdrat-b				
	Hlxfmrdrat-c				
	Hlxfmrdrat-d				
Defined in IEEE C57.110-1998					
Volts Under-Deviation	HVudev-a HVudev-b HVudev-c HVudev-d	All	$= \frac{V_{nom} - V_{rms}}{V_{nom}} * 100$	%	+/- 1%
	HVudev-ab HVudev-bc HVudev-ca				
If result is > V _{nom} then value is 0					
Where:					
V _{nom} is Declared Nominal Voltage					
V _{rms} is 200ms RMS per 61000-4-30					

**Calculations
(continued)**

Description	Abbreviation	Wiring Configuration	Formula	Units	Precision
Volts Over-Deviation	HVodev-a HVodev-b HVodev-c HVodev-d	All	$= \frac{V_{rms} - V_{nom}}{V_{nom}} * 100$ <p>If result is < V_{nom} then value is 0</p> <p>Where: V_{nom} is Declared Nominal Voltage V_{rms} is 200ms RMS Per 61000-4-30</p>	%	+/- 1%
	HVodev-ab HVodev-bc HVodev-ca				
User Specified Frequencies		All	5 individually recorded frequencies derived from DFT expansion. User selectable in 5 Hz increments.	Volts or Amps	+/- .2 %
Main Signaling Frequencies		Volts only	5 individually recorded frequencies derived from DFT expansion. User selectable in 5 Hz increments.	Volts or Amps	+/- 5 % *
Individual Harmonic Voltages 0-127 0=DC		Volts	Computed according to 61000-4-7 using DFT over 200mS window aggregated to selected journal interval as RMS	Volts	+/- 5 %
Individual Harmonic Current h0-63 h0=DC		Current	Computed according to 61000-4-7 using DFT over 200mS window aggregated to selected journal interval as RMS	Amps	+/- 5 %
* from 3% to 15% of U _{din} , +/- 5 % of measured value, from 1% to 3% of U _{din} , +/- 0.15 % of U _{din}					

**Calculations
(continued)**

Description	Abbreviation	Wiring Configuration	Formula	Units	Precision
Individual Inter Harmonic Voltages h:h+1 0-127 h0=DC		Volts	Computed according to 61000-4-7 using DFT over 200mS window aggregated to selected journal interval as RMS	Volts	+/- 5%
Individual Inter Harmonic Current h:h+1 0-63 h0=DC		Current	Computed according to 61000-4-7 using DFT over 200mS window aggregated to selected journal interval as RMS	Amps	+/- 5%
Instantaneous Flicker	Pinst-a	All	Compliant to 61000-4-15	None	+/- 8%
	Pinst-b				
	Pinst-c				
	Pinst-ab				
	Pinst-bc				
	Pinst-ca				
Instantaneous Flicker Low Pass Filter output stage	Pinstlpf-a	All	Compliant to 61000-4-15 LPF - (1 minute TC)	None	+/- 8%
	Pinstlpf-b				
	Pinstlpf-c				
	Pinstlpf-ab				
	Pinstlpf-bc				
	Pinstlpf-ca				
Instantaneous Flicker Square Root output stage	Pinstrt-a	All	Compliant to 61000-4-15 $= \sqrt{\frac{P_{inst}}{2}}$	None	+/- 8%
	Pinstrt-b				
	Pinstrt-c				
	Pinstrt-ab				
	Pinstrt-bc				
	Pinstrt-ca				
Instantaneous Flicker Square Root output stage LPF	Pinstrtlpf-a	All	Compliant to 61000-4-15 LPF - (1 minute TC) $= \sqrt{\frac{P_{inst}}{2}}$	None	+/- 8%
	Pinstrtlpf-b				
	Pinstrtlpf-c				
	Pinstrtlpf-ab				
	Pinstrtlpf-bc				
	Pinstrtlpf-ca				

**Calculations
(continued)**

Description	Abbreviation	Wiring Configuration	Formula	Units	Precision
Short Term Flicker	Pst-a	All	Compliant to 61000-4-15	None	+/- 5%
	Pst-b				
	Pst-c				
	Pst-ab				
	Pst-bc				
	Pst-ca				
Long Term Flicker	Plt-a	All	Compliant to 61000-4-15	None	+/- 5%
	Plt-b				
	Plt-c				
	Plt-ab				
	Plt-bc				
	Plt-ca				
Long Term Flicker Slide	PltSlide-a	All	Compliant to 61000-4-15 Plt value computed every Pst interval (nominal 10 min)	None	+/- 5%
	PltSlide-b				
	PltSlide-c				
	PltSlide-ab				
	PltSlide-bc				
	PltSlide-ca				
Current Demand	Idmd-a	All	Average Current of 1 sec readings over the user selected Demand interval	Amps	+/- 0.2%
	Idmd-b				
	Idmd-c				
Peak Current Demand	Ipk-a	All	Peak Current of 1 sec readings over the user selected Demand interval	Amps	+/- 0.2%
	Ipk-b				
	Ipk-c				
Current Demand Average	Idmd-avg	Polyphase only	Average of Idmd-a, Idmd-b and Idmd-c for 3 phase. For Split phase, only A and B are averaged.	Amps	+/- 0.2%
Peak Current Demand Average	Ipk-avg	Polyphase only	Average of Ipk-a, Ipk-b and Ipk-c for 3 phase. For Split phase, only A and B are averaged.	Amps	+/- 0.2%
VA coincident with Peak Watts Demand	VAcow	All	VA Demand at time of Peak Watts, during a Demand interval	VA	+/- 0.5%

**Calculations
(continued)**

Description	Abbreviation	Wiring Configuration	Formula	Units	Precision
VAR coincident with Peak Watts Demand	VARcoW	All	VAR Demand at time of Peak Watts, during a Demand interval	VAR	+/- 0.5%
Average True Power Factor coincident with Peak Watts Demand	PFavgcoW	All	Average True PF at time of Peak Watts, during a Demand interval	None	+/- 0.5%
VA coincident with Peak VAR Demand	VAcovar	All	VA Demand at time of Peak VAR, during a Demand interval	VA	+/- 0.5%
Watts coincident with Peak VAR Demand	Wcovar	All	Watts Demand at time of Peak VAR, during a Demand interval	Watts	+/- 0.5%
Average True Power Factor coincident with Peak VAR Demand	PFavgcovar	All	Average True PF at time of Peak VAR, during a Demand interval	None	+/- 0.5%
Watts coincident with Peak VA Demand	WcoVA	All	Watts Demand at time of Peak VA, during a Demand interval	Watts	+/- 0.5%
VAR coincident with Peak VA Demand	VARcoVA	All	VAR Demand at time of Peak VA, during a Demand interval	VAR	+/- 0.5%
Average True Power Factor coincident with Peak VA Demand	PFavgcoVA	All	Average True PF at time of Peak VA, during a Demand interval	None	+/- 15%
Predicted Watts Demand	Wpred-tot	All	Prediction of Watts demand before interval is complete	Watts	NA
Predicted VAR Demand	VARpred-tot	All	Prediction of VAR demand before interval is complete	VAR	NA
Predicted VA Demand	VApred-tot	All	Prediction of VA demand before interval is complete	VA	NA

**Calculations
(continued)**

Description	Abbreviation	Wiring Configuration	Formula	Units	Precision
Energy Watt-Hours	WHr-a	All	Sum of Watt readings each second scaled to Watt-Hours and accumulated into user selected interval.	Watt-h	+/- 0.22%
	WHr-b				
	WHr-c				
	WHr-d				
	WHr-tot				
Energy VAR-Hours	VARHr-a	All	Sum of VAR readings each second scaled to VAR-Hours and accumulated into user selected interval.	VAR-h	+/- 0.22%
	VARHr-b				
	VARHr-c				
	VARHr-d				
	VARHr-tot				
Energy VA-Hours	VAHr-a	All	Sum of VA readings each second scaled to VA-Hours and accumulated into user selected interval.	VA-h	+/- 0.22%
	VAHr-b				
	VAHr-c				
	VAHr-d				
	VAHr-tot				
Energy Watt-Hours, Positive flow into load	WHrpos-a	All	Absolute value of Sum of each 1 second accumulation that has a positive value.	Watt-h	+/- 0.22%
	WHrpos-b				
	WHrpos-c				
	WHrpos-d				
	WHrpos-tot				
Energy Watt-Hours, Negative flow into load	WHrneg-a	All	Absolute value of Sum of each 1 second accumulation that has a negative value.	Watt-h	+/- 0.22%
	WHrneg-b				
	WHrneg-c				
	WHrneg-d				
	WHrneg-tot				
Energy VAR-Hours, Positive flow into load	VARHrpos-a	All	Absolute value of Sum of each 1 second accumulation that has a positive value.	VAR-h	+/- 0.22%
	VARHrpos-b				
	VARHrpos-c				
	VARHrpos-d				
	VARHrpos-tot				
Energy VAR-Hours, Negative flow into load	VARHrneg-a	All	Absolute value of Sum of each 1 second accumulation that has a negative value.	VAR-h	+/- 0.22%
	VARHrneg-b				
	VARHrneg-c				
	VARHrneg-d				
	VARHrneg-tot				